



046102-300 Page 4



103104-300 Page 6



005008 Page 7-8



005012 Page 7-8



005014 Page 9-10



005016 Page 9-10

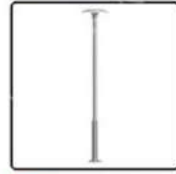

005023 Page 11-12

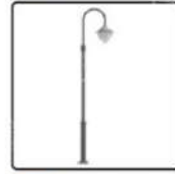

005021 Page 13-14



003076 Page 15



003081 Page 15



023381 Page 16



023382 Page 16



003110 Page 18



013110 Page 18



023110 Page 18



003110M Page 20



013110M Page 20



023110M Page 20



5080 Page 21



005063 Page 21



003037 Page 22



003035 Page 22



003327/013327 Page 23

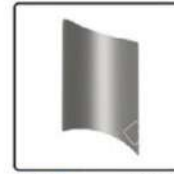

003046 Page 23

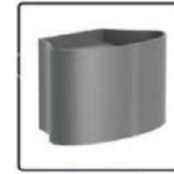

003060 Page 24

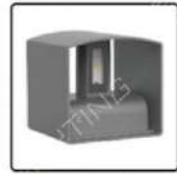

003061 Page 24



003054 Page 26



003055 Page 26



003029 Page 27



0630005 Page 27



803072 Page 28



803073 Page 28



003042 Page 30



803471 Page 30

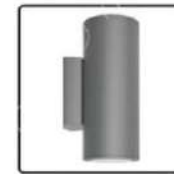

803092 Page 31



803093 Page 31



033072 Page 32



033074 Page 32



133474 Page 34



033481 Page 34



033491 Page 34



023028/003026 Page 36



003332 Page 38



003336 Page 38



003443 Page 40



003056 Page 40



003033 Page 42



003048 Page 42



003066/004066 Page 44



003087/004087 Page 44



003088/004088 Page 44



003508+B Page 46



013508+B Page 46



023508+B Page 46



033508+B Page 46



003861+B Page 47



003862+B Page 48



013863+B Page 49



023864+B Page 49



013855+B Page 50



003582+B Page 52



013582+B Page 52



003243-60 Page 53



013243-60 Page 53



023243-60 Page 54



023231-80 Page 55



003103RH-60 Page 55



003121-30 Page 56



003121-80 Page 58



003104-80 Page 60



003102-80 Page 60



005083 Page 61



6081-80 Page 62



013279 Page 63



013281 Page 63



005281D Page 63



063279-60 Page 64



095281-60 Page 64



003240-80 Page 66



013296-80 Page 66



007226 Page 68



003231-80 Page 68



003729DZ Page 70



003729 Page 70



003723DZ Page 72



003723 Page 72



003731DZ Page 74



003731 Page 74



043763 Page 74



013363DZ Page 75



013364DZ Page 75



013353 Page 76



013354 Page 76



003554DZ Page 76



003601 Page 78



003651 Page 78

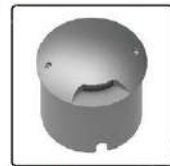

013526+B Page 80



023526+B Page 80

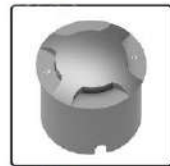

003526+B Page 80



023583+B Page 81



043670+B Page 81

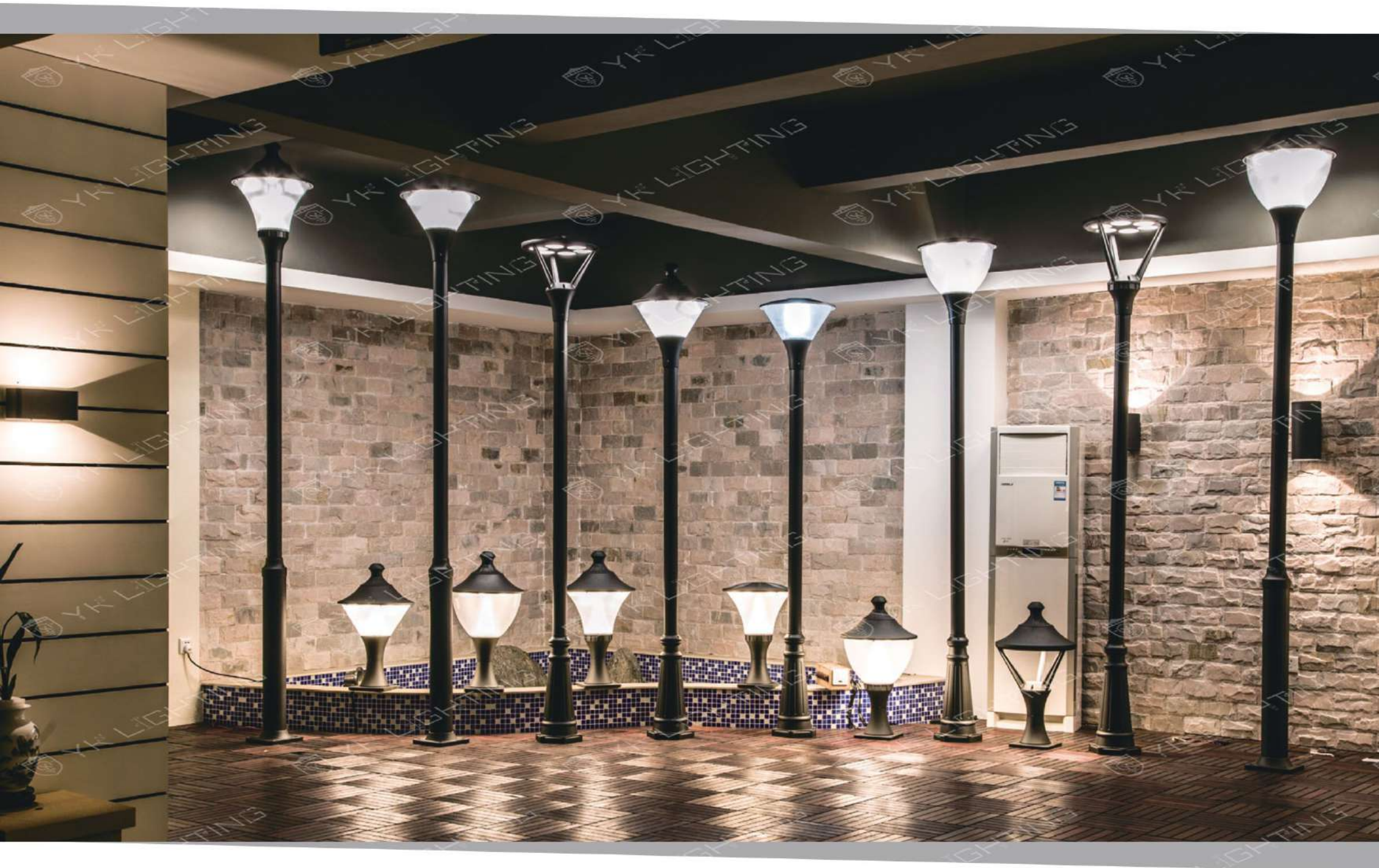



● P-046102-300
LED: CREE-COB 30W

燈具規範

- 鋁合金壓鑄及鋁擠型燈具本體
- 燈罩為透明強化安全玻璃
- 矽膠防水墊圈
- 220°C 高溫粉體烤漆

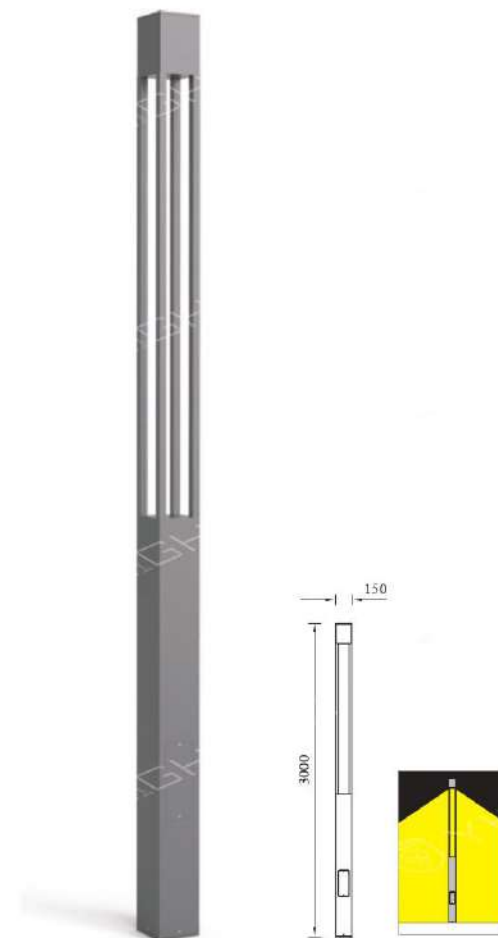

● P-103104-300
LED: CREE-COB 30W

燈具規範

- 鋁合金壓鑄及鋁擠型燈具本體
- 燈罩為透明強化安全玻璃
- 矽膠防水墊圈
- 220°C 高溫粉體烤漆



- **T-005008**
LED: OSRAM 36W
- **T-5008** E27

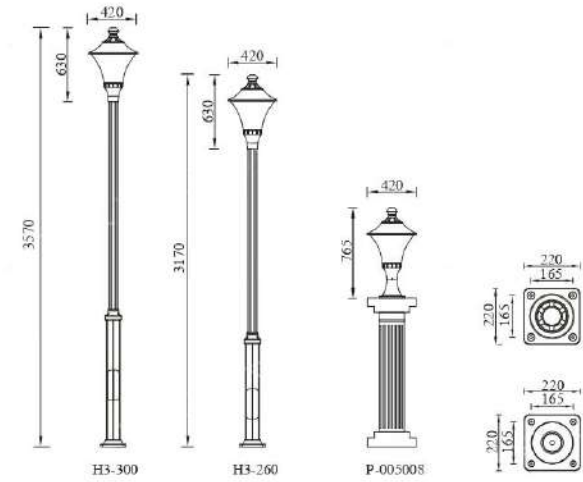

- **T-005012**
LED: OSRAM 36W
- **T-5012** E27

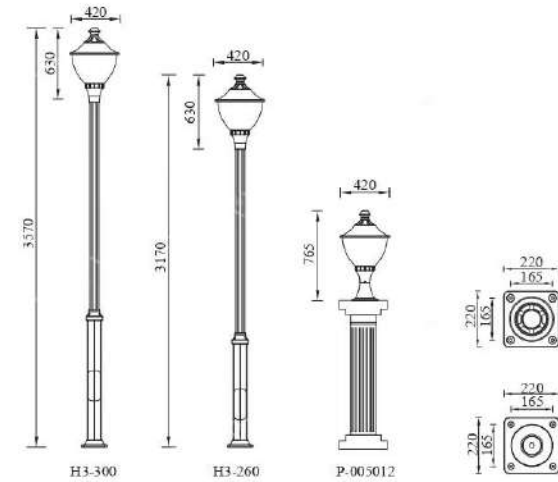

燈具規範

- 鋁合金壓鑄燈具本體
- 燈罩為霧面PC塑膠射出一體成型
- 白色圓錐型塑膠射出導光柱
- 矽膠防水墊圈
- 220°C高溫粉體烤漆



● **T-005014**
LED: OSRAM 36W



● **T-005016**
LED: OSRAM 36W

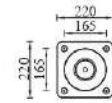
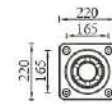
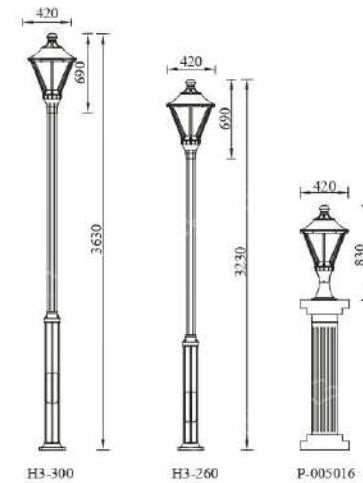
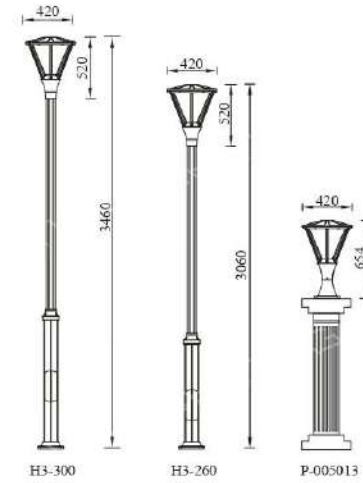

燈具規範

- 鋁合金壓鑄燈具本體
- 燈罩為霧面PC塑膠射出一體成型
- 矽膠防水墊圈
- 220°C 高溫粉體烤漆

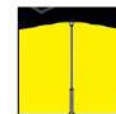
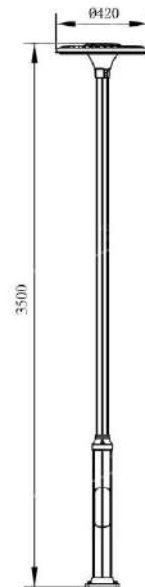

● T-005023
LED: OSRAM 60W

燈具規範

- 鋁合金壓鑄燈具本體
- 燈罩為乳白PC罩膠射出一體成型
- 鋁擠型條紋管兩節式燈桿
- 矽膠防水墊圈
- 220°C 高溫粉體烤漆

IP65



● T-005021
LED: OSRAM 36W

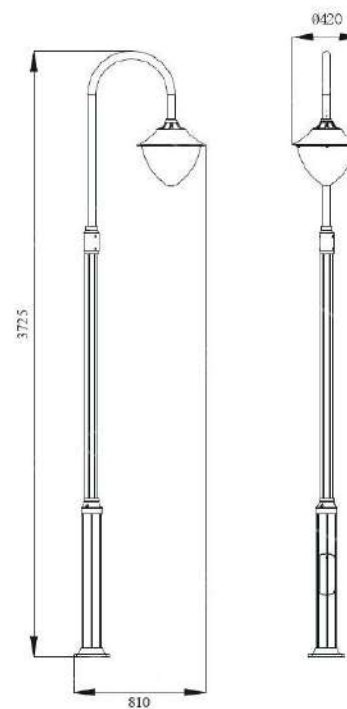

燈具規範

- 鋁合金壓鑄燈具本體
- 燈罩為霧面PC塑膠射出一體成型
- 鋁質型條紋管兩節式燈桿
- 矽膠防水墊圈
- 220°C高溫粉體烤漆



● B-003076 LED: OSRAM 12W

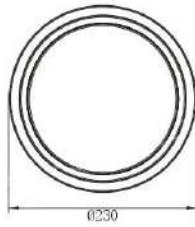

● B-023381 LED: OSRAM 8W

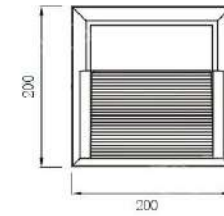

● B-003081 LED: OSRAM 12W

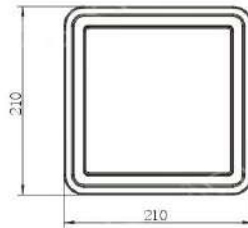

● B-023382 LED: OSRAM 8W

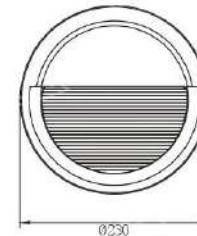

燈具規範

- 鋁合金壓鑄燈具本體
- 燈罩為雙層乳白+透明PC塑膠射出一體成型
- 矽膠防水墊圈
- 220°C高溫粉體烤漆

燈具規範

- 鋁合金壓鑄燈具本體
- 燈罩為乳白PC塑膠射出一體成型
- 矽膠防水墊圈
- 220°C高溫粉體烤漆



● **B-003110** LED: OSRAM 6W

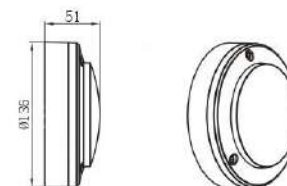

● **B-013110** LED: OSRAM 6W

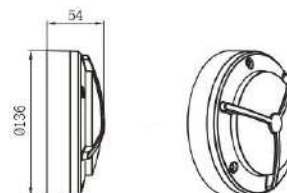

● **B-023110** LED: OSRAM 6W

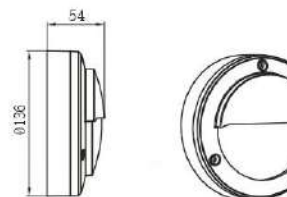

燈具規範

- 鋁合金壓鑄燈具本體
- 燈罩為乳白PC塑膠射出一體成型
- 矽膠防水墊圈
- 220°C高溫粉體烤漆



● B-003110M LED: OSRAM 16W



● B-013110M LED: OSRAM 16W



● B-023110M LED: OSRAM 16W



燈具規範

- 鋁合金壓鑄燈具本體
- 燈罩為乳白PC塑膠射出一體成型
- 矽膠防水墊圈
- 220°C高溫粉體烤漆



● B-5080 E27

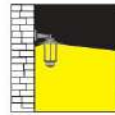
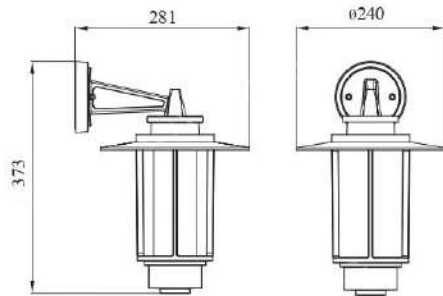

● B-003037
LED: CREE-COB 6Wx2

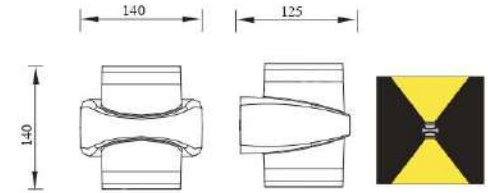

● B-005083
LED: CREE-COB 8W

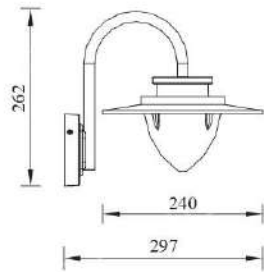

● B-003035
LED: CREE-COB 8W

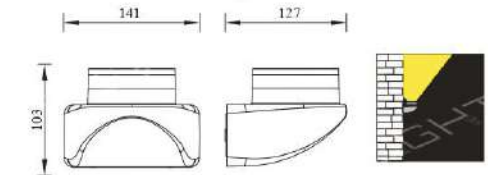

燈具規範

- 鋁合金壓鑄燈具本體
- 燈罩為乳白PC塑膠射出一體成型
- 矽膠防水墊圈
- 220°C高溫粉體烤漆

燈具規範

- 鋁合金壓鑄燈具本體
- 燈罩為乳白PC+透明強化安全玻璃
- 矽膠防水墊圈
- 220°C高溫粉體烤漆



B-003327
LED: OSRAM 10W



B-013327
LED: CREE 6Wx2

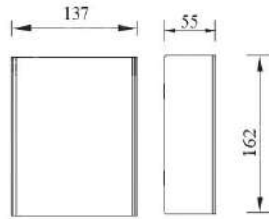

B-003060
LED: CREE-COB 3Wx2

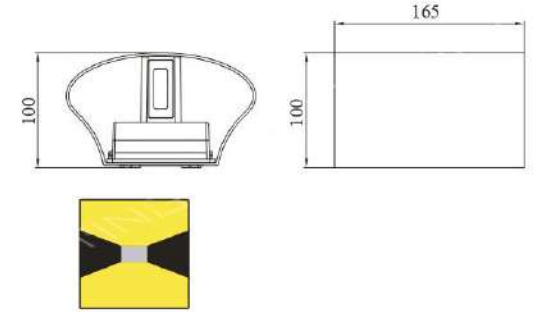

B-003046
LED: CREE-COB 6Wx2

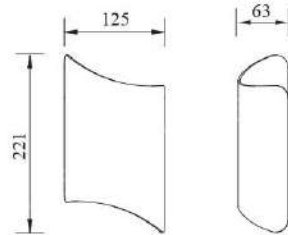

B-003061
LED: CREE-COB 3Wx2

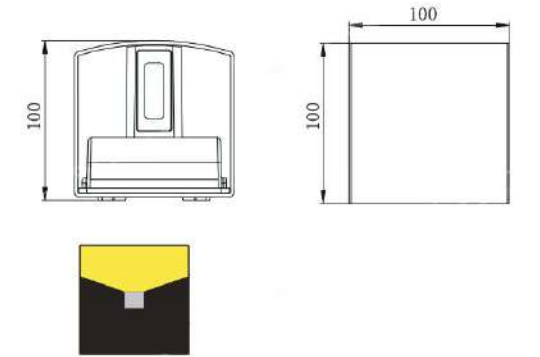

燈具規範

- 鋁合金壓鑄燈具本體
- 燈罩為透明強化安全玻璃
- 矽膠防水墊圈
- 220°C高溫粉體烤漆

燈具規範

- 鋁合金壓鑄燈具本體
- 燈罩為透明強化安全玻璃
- 矽膠防水墊圈
- 220°C高溫粉體烤漆



● B-003054
LED: OSRAM 8W

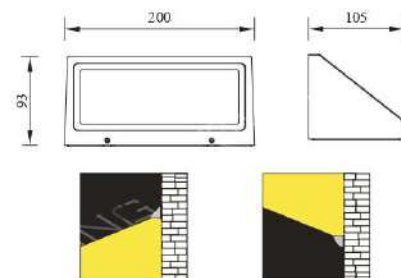

● B-003055
LED: OSRAM 8W

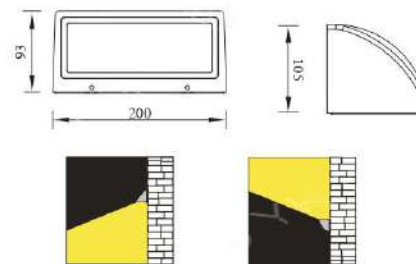

燈具規範

- 鋁合金壓鑄燈具本體
- 燈罩有透明強化安全玻璃
- 矽膠防水墊圈
- 220°C 高溫粉體烤漆



● **B-003029** LED: OSRAM 10W

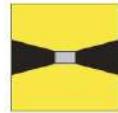
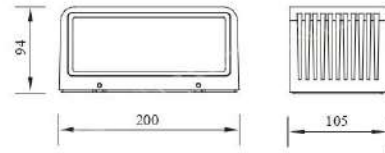

● **B-803072**
LED: CREE-COB 8W

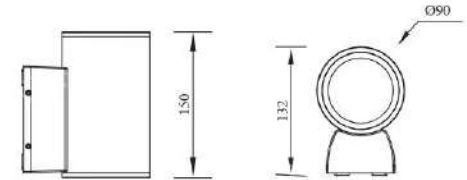

● **B-063000S** LED: OSRAM 10W

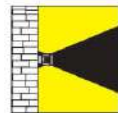
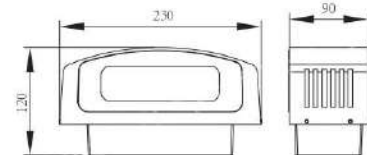

● **B-803073**
LED: CREE-COB 12W

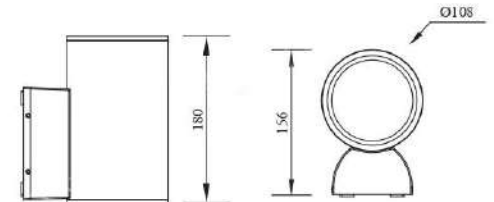

燈具規範

- 鋁合金壓鑄燈具本體
- 燈罩為透明強化安全玻璃
- 矽膠防水墊圈
- 220°C 高溫粉體烤漆

燈具規範

- 鋁合金壓鑄燈具本體
- 燈罩為透明強化安全玻璃
- 矽膠防水墊圈
- 220°C 高溫粉體烤漆



● B-003042
LED: CREE 4Wx2

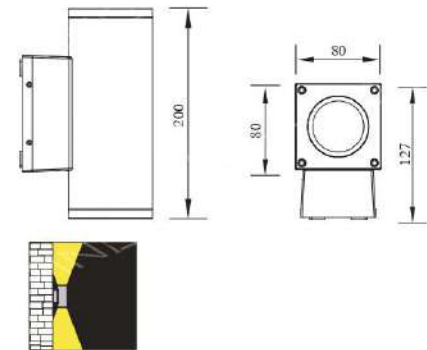

● B-803471
LED: CREE-COB 8W

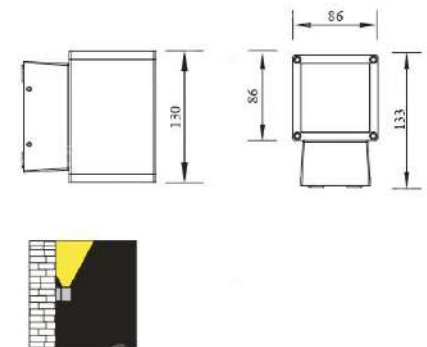

燈具規範

- 鋁合金壓鑄燈具本體
- 燈罩為透明強化安全玻璃
- 矽膠防水墊圈
- 220°C 高溫粉體烤漆



● **B-803092**
LED: CREE-COB 6Wx2

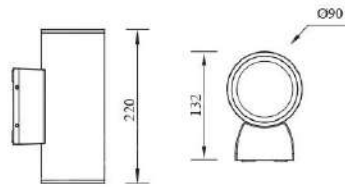

● **B-033072**
LED: CREE-COB 6W

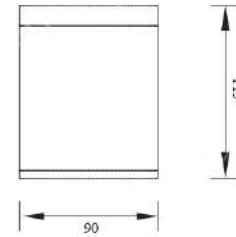

● **B-803093**
LED: CREE-COB 12Wx2

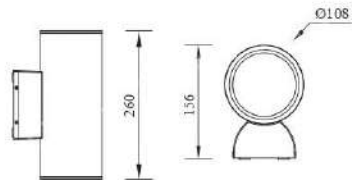

● **B-033074**
LED: CREE-COB 12W

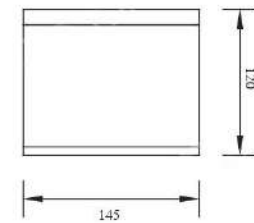

燈具規範

- 鋁合金壓鑄燈具本體
- 燈罩為透明強化安全玻璃
- 矽膠防水墊圈
- 220°C 高溫粉體烤漆

燈具規範

- 鋁合金壓鑄燈具本體
- 燈罩為透明強化安全玻璃
- 矽膠防水墊圈
- 220°C 高溫粉體烤漆

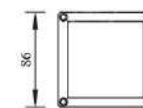
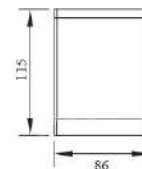

● **B-133474**
LED: CREE-COB 6W

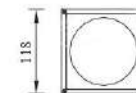
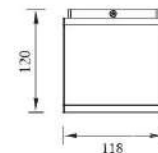

● **B-033481**
LED: CREE-COB 8W

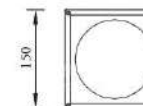
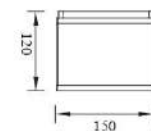

● **B-033491**
LED: CREE-COB 12W

燈具規範

- 鋁合金壓鑄燈具本體
- 燈罩為透明強化安全玻璃
- 矽膠防水墊圈
- 220°C 高溫粉體烤漆

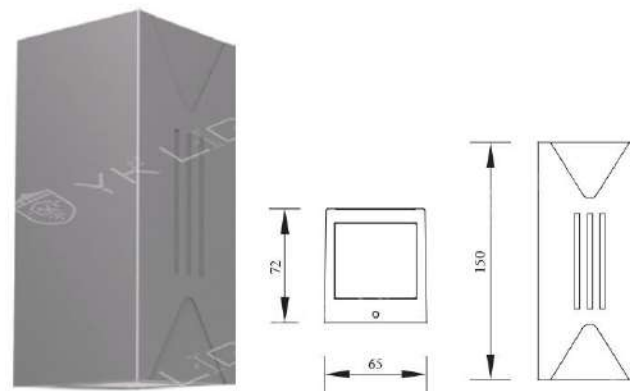

● **B-023028**
LED: OSRAM 3Wx2



● **B-003028**
LED: CREE 3Wx2

燈具規範

- 鋁合金壓鑄燈具本體
- 燈罩為透明強化安全玻璃
- 矽膠防水墊圈
- 220°C 高溫粉體烤漆

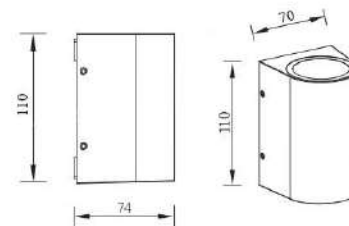
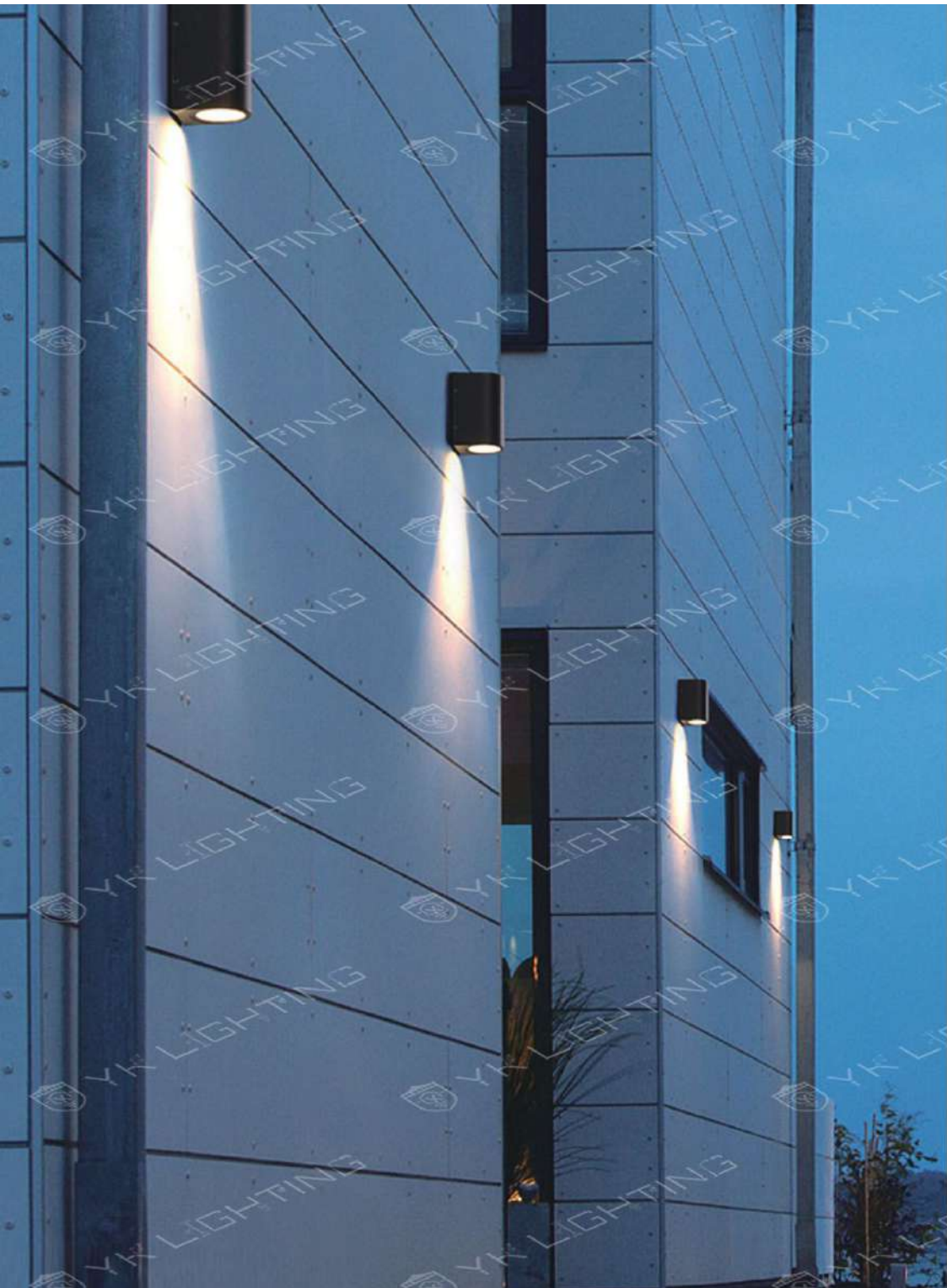

● **B-003332**
LED: CREE 3W

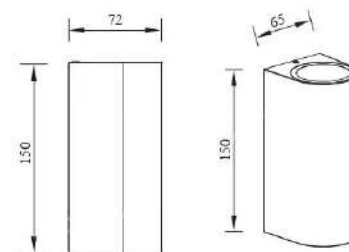

● **B-003336**
LED: CREE 3Wx2



燈具規範

- 鋁合金壓鑄燈具本體
- 燈罩為透明強化安全玻璃
- 矽膠防水墊圈
- 220°C 高溫粉體烤漆

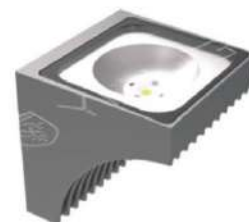

● B-003443
LED: CREE-COB 12W

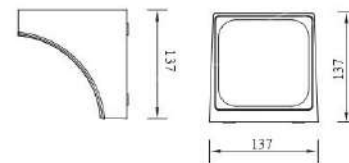

● B-003056
LED: CREE-COB 3W

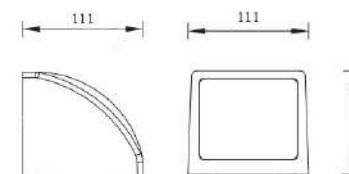

燈具規範

- 鋁合金壓鑄燈具本體
- 燈罩為透明強化安全玻璃
- 矽膠防水墊圈
- 220°C 高溫粉體烤漆



● B-003033 LED:1Wx4

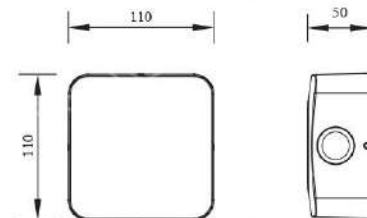

● B-003048 LED:OSRAM 3Wx4

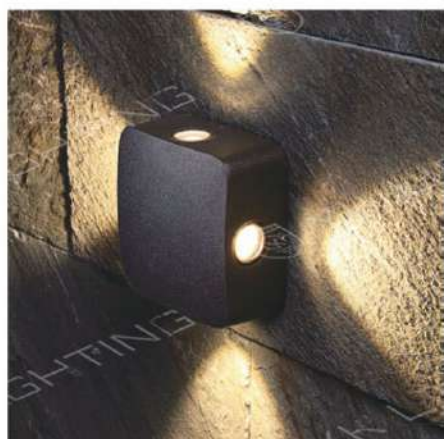
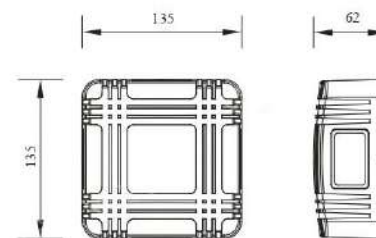

燈具規範

- 鋁合金壓鑄燈具本體
- 燈罩為透明強化安全玻璃
- 矽膠防水墊圈
- 220°C高溫粉體烤漆

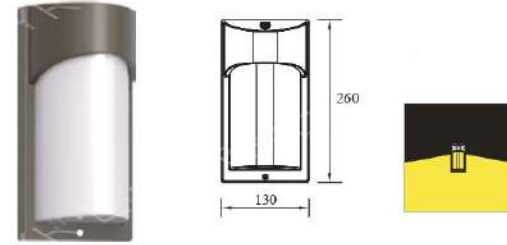

● B-003086 LED: OSRAM 8W
B-004086 E27



● B-003087 LED: OSRAM 8W
B-004087 E27

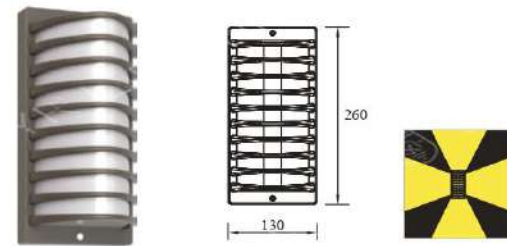

● B-003088 LED: OSRAM 8W
B-004088 E27

燈具規範

- 鋁合金壓鑄燈具本體
- 燈罩為乳白PC塑膠射出一體成型
- 矽膠防水墊圈
- 220°C高溫粉體烤漆



● M-003508+B LED: OSRAM 5W

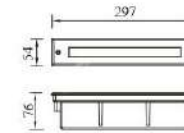

● M-013508+B LED: OSRAM 5W

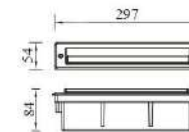

● M-023508+B LED: OSRAM 5W

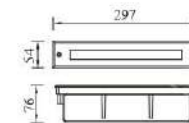

● M-033508+B LED: OSRAM 5W

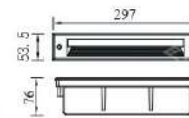

燈具規範

- 鋁合金壓鑄燈具本體
- 燈罩為乳白PC或透明強化安全玻璃
- 工程塑膠埋盒
- 矽膠防水墊圈
- 220°C高溫粉體烤漆

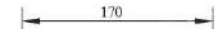

● M-003862+B
LED: OSRAM 3W

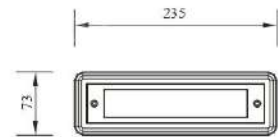
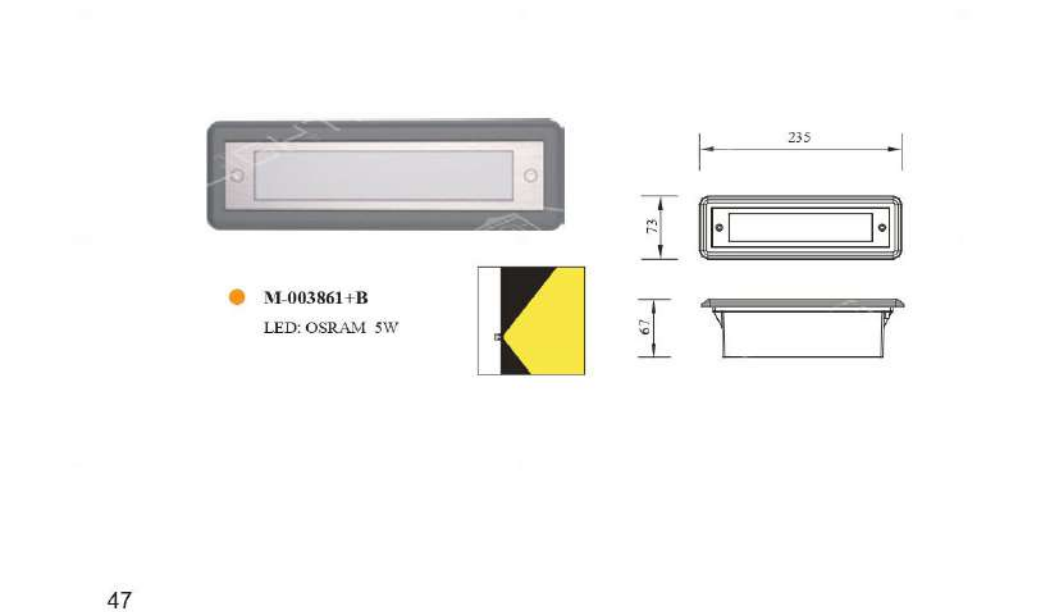
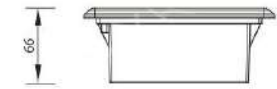

● M-003861+B
LED: OSRAM 5W



燈具規範

- 鋁合金壓鑄燈具本體
- 面罩不銹鋼邊框
- 燈罩為乳白PC塑膠射出一體成型
- 工程塑膠埋盒
- 矽膠防水墊圈
- 220°C 高溫粉體烤漆



● Q-013863+B
LED: OSRAM 4W



● Q-023864+B
LED: OSRAM 4W

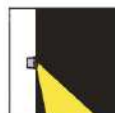

● Q-013865+B
LED: OSRAM 2W

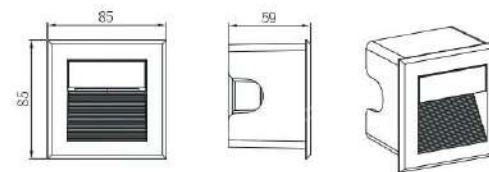

燈具規範

- 鋁合金底鑄燈具本體
- 燈罩為透明強化安全玻璃
- 工程塑膠埋盒
- 矽膠防水墊圈
- 220°C 高溫粉體烤漆

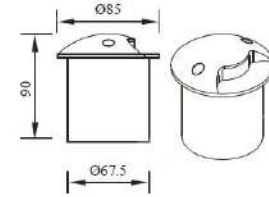

● **M-003582+B**
LED: CREE 2W

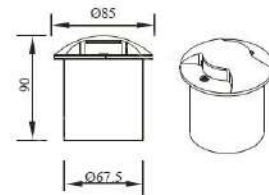

● **M-013582+B**
LED: OSRAM 2W



燈具規範

- 鋁合金底鑄燈具本體
- 燈罩為透明PC塑膠射出一體成型
- 鉅鑽型埋埋筒
- 矽膠防水墊圈
- 220°C高溫粉體烤漆

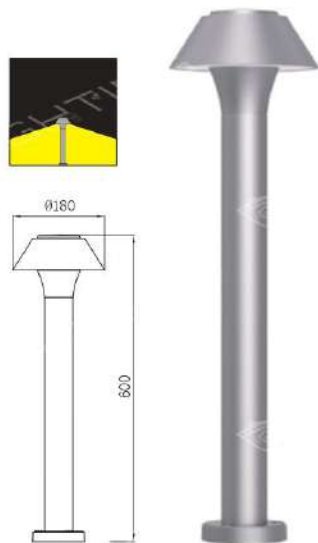

● P-013243-60
LED: CREE-COB 12W



● P-023243-60
LED: CREE-COB 12W

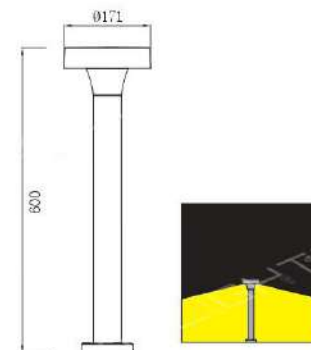

● P-003243-60
LED: OSRAM 12W

燈具規範

- 鋁合金壓鑄及鋁擠型燈具本體
- 燈罩為乳白PC膠射出一體成型
- 矽膠防水墊圈
- 220°C高溫粉體烤漆

燈具規範

- 鋁合金壓鑄及鋁擠型燈具本體
- 燈罩為乳白PC膠射出一體成型
- 矽膠防水墊圈
- 220°C高溫粉體烤漆

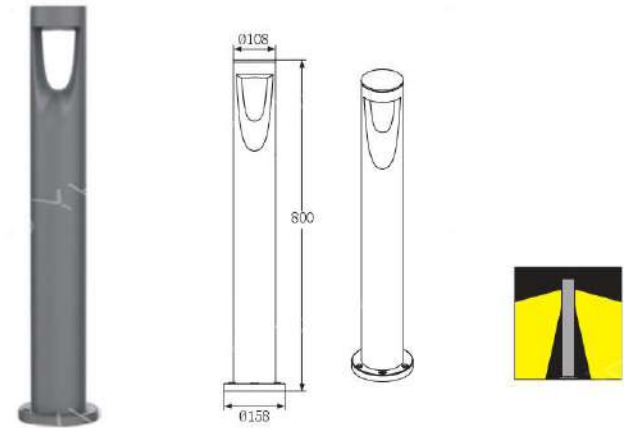

● P-023231-80
LED: LUMILEDS 12W

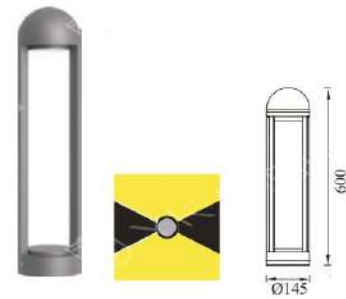

● P-003103RH-60
LED: CREE-COB 8W



燈具規範

- 鋁合金壓鑄及鋁擠型燈具本體
- 燈罩為透明強化安全玻璃
- 矽膠防水墊圈
- 220°C 高溫粉體烤漆

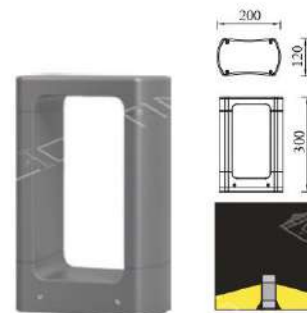

● P-003121-30
LED: CREE-COB 8W



● P-003121-80
LED: CREE-COB 8W

燈具規範

- 鋁合金壓鑄及鋁擠型燈具本體
- 燈罩為透明強化安全玻璃
- 矽膠防水墊圈
- 220°C 高溫粉體烤漆

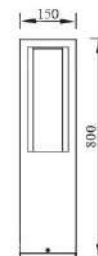

● P-003104-80
LED: CREE-COB 8W

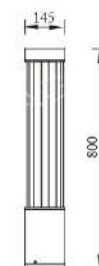

● P-003102-80
LED: CREE-COB 8W

燈具規範

- 鋁合金壓鑄及鋁擠型燈具本體
- 燈罩為透明強化安全玻璃
- 矽膠防水墊圈
- 220°C 高溫粉體烤漆



● P-005083
LED: CREE-COB 8W

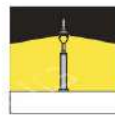
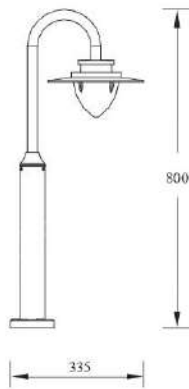

燈具規範

- 鋁合金燈殼及鋁擠型燈具本體
- 燈罩為乳白PC塑膠射出一體成型
- 矽膠防水墊圈
- 220°C高溫粉體烤漆



● P-6081-80 E27

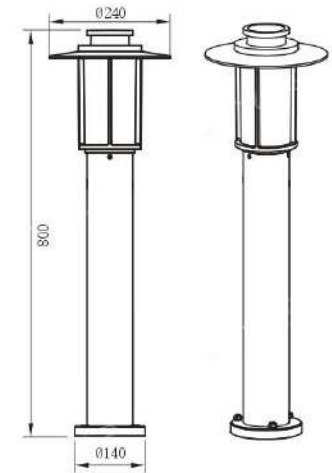

燈具規範

- 鋁合金燈殼及鋁擠型燈具本體
- 燈罩為乳白PC塑膠射出一體成型
- 矽膠防水墊圈
- 220°C高溫粉體烤漆



● P-013279
LED: CREE-COB 12W



● P-013281
LED: CREE-COB 12W



● P-005281D E27

燈具規範

- 鋁合金壓鑄燈具本體
- 燈罩為透明PC塑膠射出一體成型
- 矽膠防水墊圈
- 220°C高溫粉體烤漆

IP65

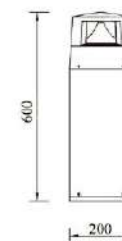

● P-083279-60
LED: CREE-COB 12W

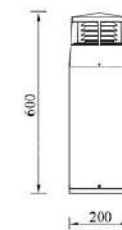

● P-095281D-60 E27

燈具規範

- 鋁合金壓鑄及鋁擠型燈具本體
- 燈罩為透明PC塑膠射出一體成型
- 矽膠防水墊圈
- 220°C高溫粉體烤漆

IP65

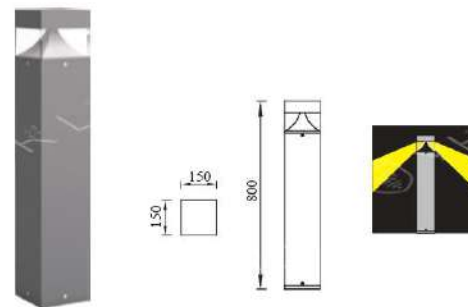

● **P-003240-80**
LED: OSRAM 12W

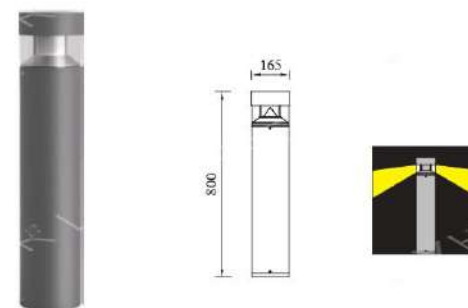

● **P-013236-80**
LED: CREE-COB 8W

燈具規範

- 鋁合金壓鑄及鋁擠型燈具本體
- 燈罩為透明PC塑膠射出一體成型
- 矽膠防水墊圈
- 220°C高溫粉體烤漆

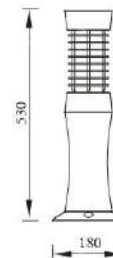

燈具規範

- 鋁合金壓鑄及鋁擠型燈具本體
- 燈罩為乳白PC塑膠射出一體成型
- 矽膠防水墊圈
- 220°C高溫粉體烤漆

● P-007226 E27



燈具規範

- 鋁合金壓鑄及鋁擠型燈具本體
- 燈罩為透明強化安全玻璃
- 矽膠防水墊圈
- 220°C高溫粉體烤漆

● P-003231-80
LED: CREE-COB 8W

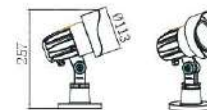

● G-003729DZ
LED: CREE-COB 12W

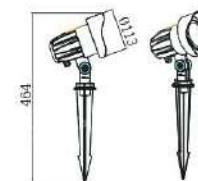

● C-003729
LED: CREE-COB 12W



燈具規範

- 鋁合金壓鑄燈具本體
- 燈罩為透明強化安全玻璃
- 矽膠防水墊圈
- 220°C 高溫粉體烤漆

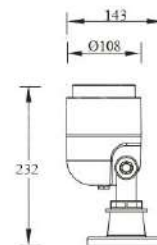

● **G-003723DZ**
LED: CREE-COB 12W

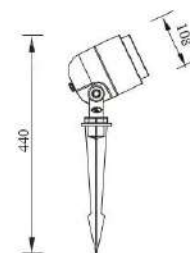

● **C-003723**
LED: CREE-COB 12W

燈具規範

- 鋁合金壓鑄燈具本體
- 燈罩為透明強化安全玻璃
- 矽膠防水墊圈
- 220°C 高溫粉體烤漆

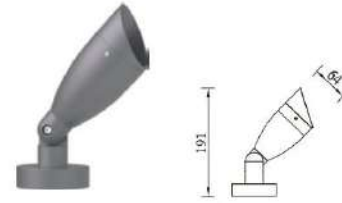

● **G-003731DZ**
LED: OSRAM 4W



● **C-003731**
LED: OSRAM 4W



● **C-043783**
LED: CREE-COB 12W



燈具規範

- 鋁合金壓鑄燈具本體
- 燈罩為透明強化安全玻璃
- 矽膠防水墊圈
- 220°C 高溫粉體烤漆



● **C-013363**
LED: OSRAM 6W



● **C-013364**
LED: CREE-COB 8W

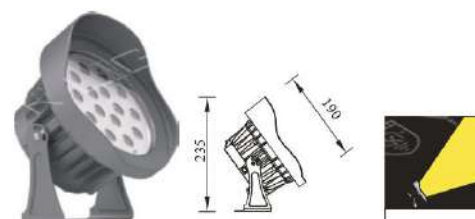

● **G-003554DZ**
LED: OSRAM 15W

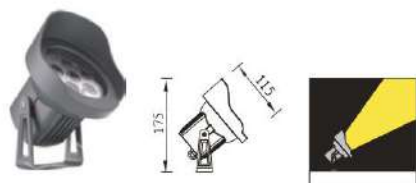

● **G-013363DZ**
LED: OSRAM 6W

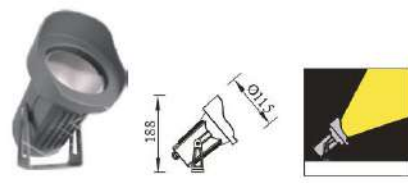

● **G-013364DZ**
LED: CREE-COB 8W

燈具規範

- 鋁合金壓鑄燈具本體
- 燈罩為透明強化安全玻璃
- 矽膠防水墊圈
- 220°C 高溫粉體烤漆



IP65

POOL LIGHT

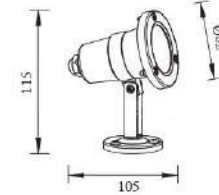

● S-003601
LED: 1Wx3

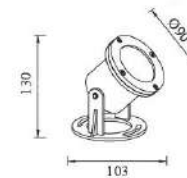

● S-003651
LED: 1Wx3



燈具規範

- 不銹鋼燈具本體
- 不銹鋼支架
- 燈罩透明強化安全玻璃
- 矽膠防水墊圈
- 本產品均為低壓水池燈,變壓器需外置

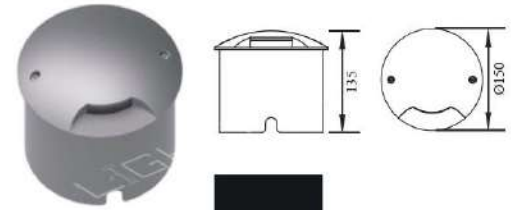

● M-013526+B
LED: CREE 3W

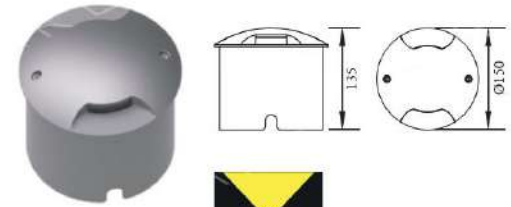

● M-023526+B
LED: CREE 6W

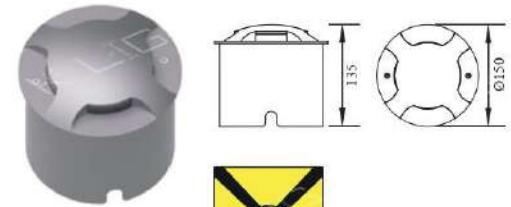

● M-003526+B
LED: CREE 12W



燈具規範

- 鋁合金壓鑄燈具本體
- 燈罩為透明PC塑膠射出一體成型
- 鋁擠型預埋管
- 矽膠防水墊圈
- 220°C高溫粉體烤漆



● M-023583+B
LED: OSRAM 6W

燈具規範

- 不銹鋼燈具面框
- 鋁合金壓鑄燈具本體
- 燈罩透明強化安全玻璃
- 工程塑膠埋盒
- 矽膠防水墊圈
- 220°C高溫粉體烤漆

IP67



● M-043670+B
LED: CREE 4W