

Fornilunce Outdoor lighting

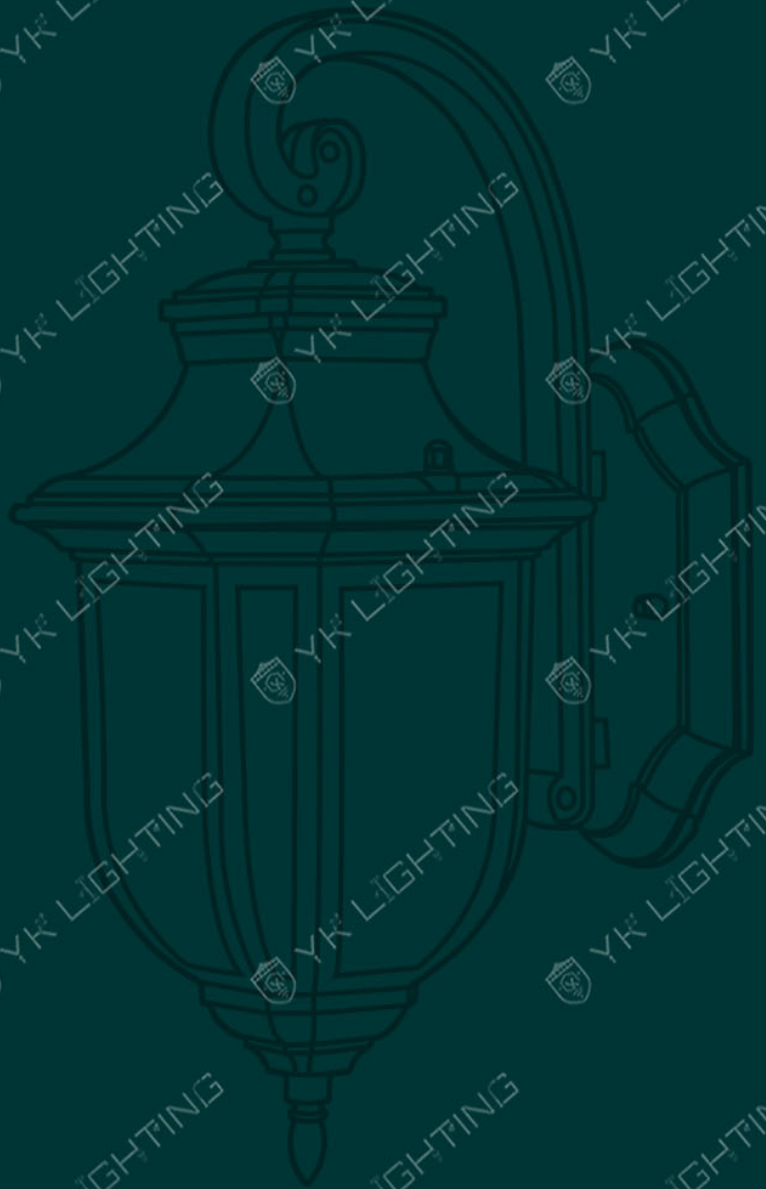

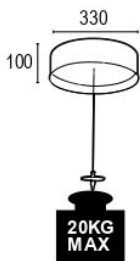

遙控升降，便捷安全。
 電壓 110V 及特殊規格可訂製
 適用於高天井、大型吊燈、
 挑高空間、電壓 220V



FL-7001-1 53000
 Ø330 H100 mm
 載重 20 公斤
 配置 20 米鋼線
 載重物：6~20 公斤

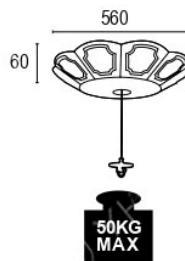

FL-7001-2 62000
 Ø560 H60 mm
 載重 50 公斤
 配置 4 米鋼線
 載重物：15~50 公斤

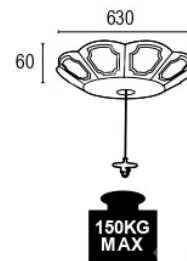

FL-7001-3 107000
 Ø630 H60 mm
 載重 150 公斤
 配置 6 米鋼線
 載重物：50~150 公斤

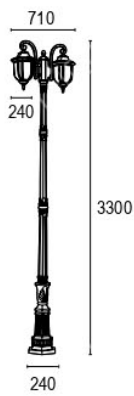

FL-7002-1

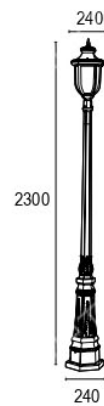

FL-7002-2

產編	尺寸	光源	電壓	材質
FL-7002-1 48000	W710 H3300 D240mm	E27 LEDx2 另計	110V~220V	鋁材平光黑 + 玻璃燈罩
FL-7002-2 21000	W240 H2300mm	E27 LEDx1 另計		鋁材平光黑 + 玻璃燈罩

規範: 鋁合金壓鑄燈具本體 燈罩強化打砂玻璃 燈桿鋁合金壓鑄 高溫粉體烤漆 IP55 基礎座另計



FL-7003-1



FL-7003-2

產 編	尺 寸	光 源	電 壓	材 質
FL-7003-1 9800	W250 H520 D300mm	E27 LEDx1 另計	110V~220V	鋁材平光黑 + 玻璃燈罩
FL-7003-2 5800	W160 H380 D220mm	E27 LEDx1 另計		鋁材平光黑 + 玻璃燈罩

規範：鋁合金壓鑄燈具燈體 高溫粉體烤漆



FL-7004-1



FL-7004-2

產編	尺寸	光源	電壓	材質
FL-7004-1 35000	W800 H2650 D250mm	E27 LEDx2 另計	110V~220V	鋁材平光黑描金 + 玻璃燈罩
FL-7004-2 8500	W190 H860mm	E27 LEDx1 另計		鋁材平光黑描金 + 玻璃燈罩

規範: 鋁合金壓鑄燈具本體 燈罩氣泡清光玻璃 燈桿鋁合金壓鑄 高溫粉體烤漆 IP55 基礎座另計

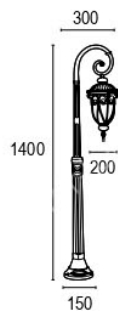

FL-7005-1

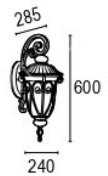

FL-7005-2

產 編	尺 寸	光 源	電 壓	材 質
FL-7005-1 12500	W200 H1400 D300mm	E27 LEDx1 另計	110V~220V	鋁材平光黑描金 + 玻璃燈罩
FL-7005-2 9800	W240 H600 D285mm	E27 LEDx1 另計		鋁材平光黑描金 + 玻璃燈罩

規範：鋁合金壓鑄燈具本體 燈罩氣泡清光玻璃 燈桿鋁合金壓鑄 高溫粉體烤漆 IP55

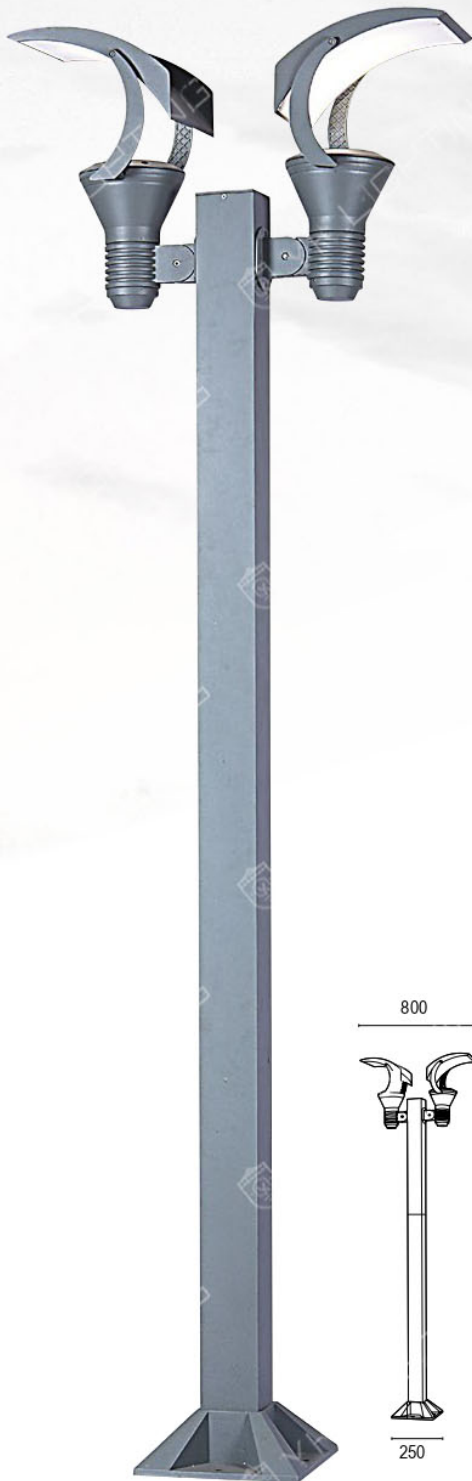

FL-7006-1



FL-7006-2

產編	尺寸	光源	電壓	材質
FL-7006-1 44300	W800 H2300mm	E27 PAR38 LEDx2 另計	110V~220V	鋁材砂灰色
FL-7006-2 7500	W220 H430 D360mm	E27 LEDx1 另計		鋁材砂灰色

規範：鋁合金壓鑄燈具本體 燈桿鋁材 IP55 基礎座另計

Therefore, in the design, we should consider both the condition limitation and the overall road block appearance, and the ultimate realization of the scheme is very good to meet the above conditions, and become a successful case of good integration with the urban block as a whole.

If you leave, you enter the market, and you are responsible for seclusion. It is fornilunce's philosophy of life to be quiet and have a good command of style.



產 編	尺 寸	光 源	電 壓	材 質
FL-7007-1 35000	W630 H2100mm	LED 20W 3000K	110V~220V	鋁材砂黑色 +PC

規範：鋁合金壓鑄燈具本體 PC 乳白燈罩 燈桿鋁材 IP55 基礎座另計



FL-7008-1

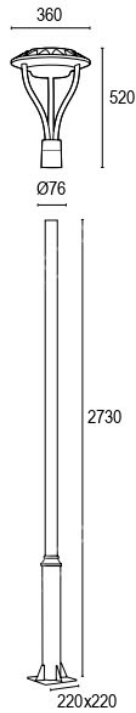

產 編	尺 寸	光 源	電 壓	材 質
FL-7008-1 70000	W360 H3250mm	LED 100W 5000K	110V~220V	鋁材砂黑色 +PC

規範：鋁合金壓鑄燈具本體 PC 乳白燈罩：矽膠防水墊圈 燈桿：熱鍍鋅鋼管管徑 76 高溫粉體烤漆 IP65
 CREE 燈珠 明緯驅動 光源質保二年 基礎座另計



FL-7009-1

FL-7009-2

產 編	尺 寸	光 源	電 壓	材 質
FL-7009-1 54000	W610 H2920mm	LED100W PHILIPS 3000K	110V~120V	鋁材砂黑色
FL-7009-2 60000	W1011 H3180mm	LED100W PHILIPS 3000K		鋁材砂黑色

規範: 鋁合金壓鑄燈具本體 燈罩強化清光玻璃 燈桿熱鍍鋅鋼管 高溫粉體烤漆平光黑 IP65 管徑 60mm
 基礎座另計 飛利浦燈珠 明緯驅動 光源質保一年

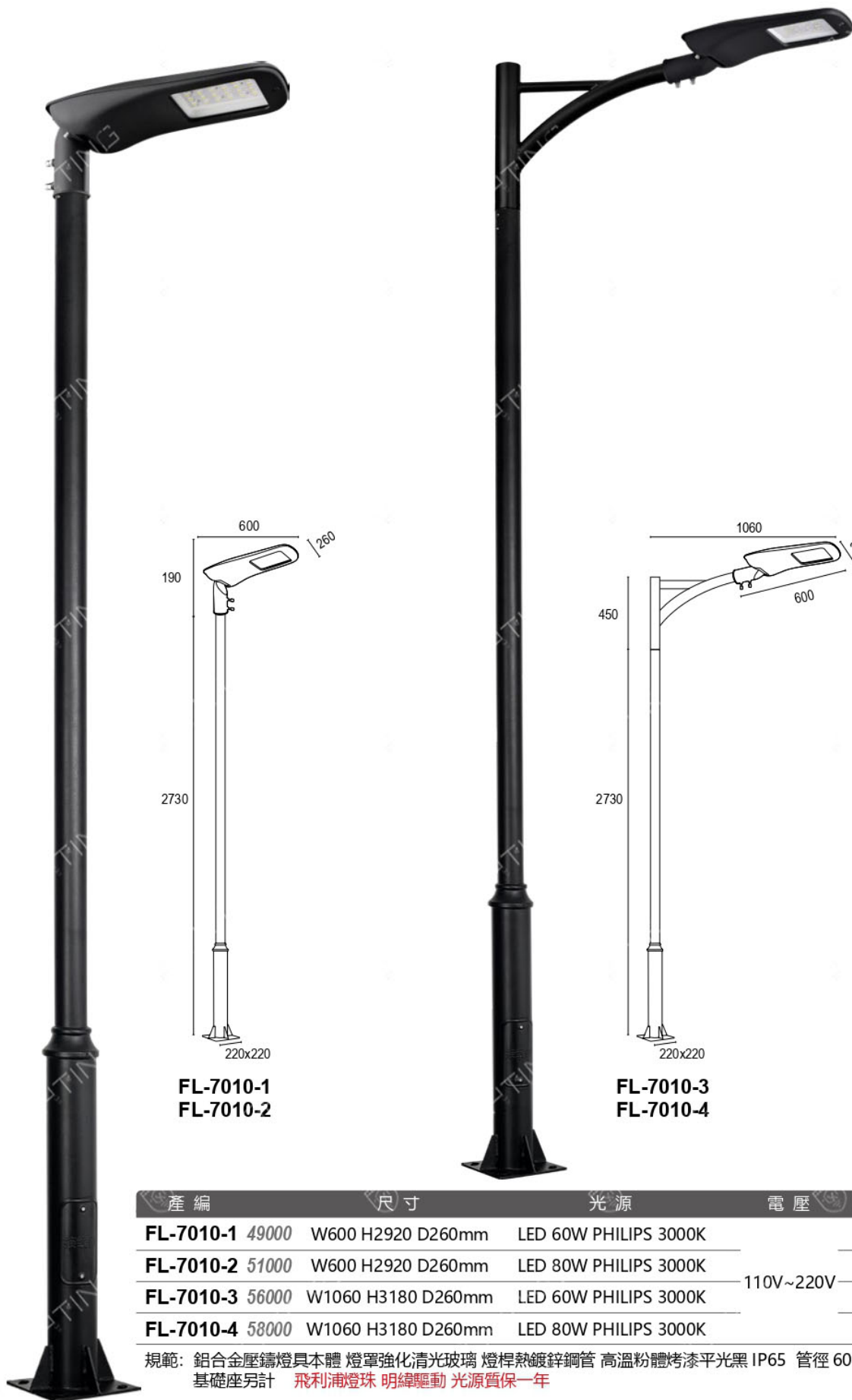

FL-7010-1
FL-7010-2

FL-7010-3
FL-7010-4

產 編	尺 寸	光 源	電 壓	材 質
FL-7010-1 49000	W600 H2920 D260mm	LED 60W PHILIPS 3000K	110V~220V	鋁材砂黑色
FL-7010-2 51000	W600 H2920 D260mm	LED 80W PHILIPS 3000K		鋁材砂黑色
FL-7010-3 56000	W1060 H3180 D260mm	LED 60W PHILIPS 3000K	110V~220V	鋁材砂黑色
FL-7010-4 58000	W1060 H3180 D260mm	LED 80W PHILIPS 3000K		鋁材砂黑色

規範: 鋁合金鑄燈具本體 燈罩強化清光玻璃 燈桿熱鍍鋅鋼管 高溫粉體烤漆平光黑 IP65 管徑 60mm
 基礎座另計 飛利浦燈珠 明緯驅動 光源質保一年

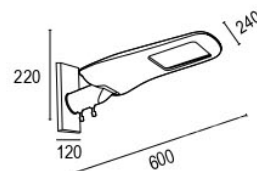
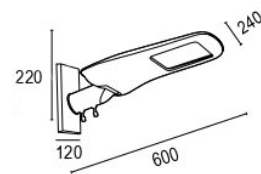

產 編	尺 寸	光 源	電 壓	材 質
FL-7011-1 27000	W240 H220 D600mm	LED 80W PHILIPS 3000K	110V~220V	鋁材砂黑色
FL-7011-2 25000	W240 H220 D600mm	LED 60W PHILIPS 3000K		鋁材砂黑色

規範：鋁合金壓鑄燈具本體 燈罩強化清光玻璃 矽膠防水墊圈 壁座不銹鋼高溫粉體烤漆 IP65
 飛利浦燈珠 明緯驅動 光源質保一年

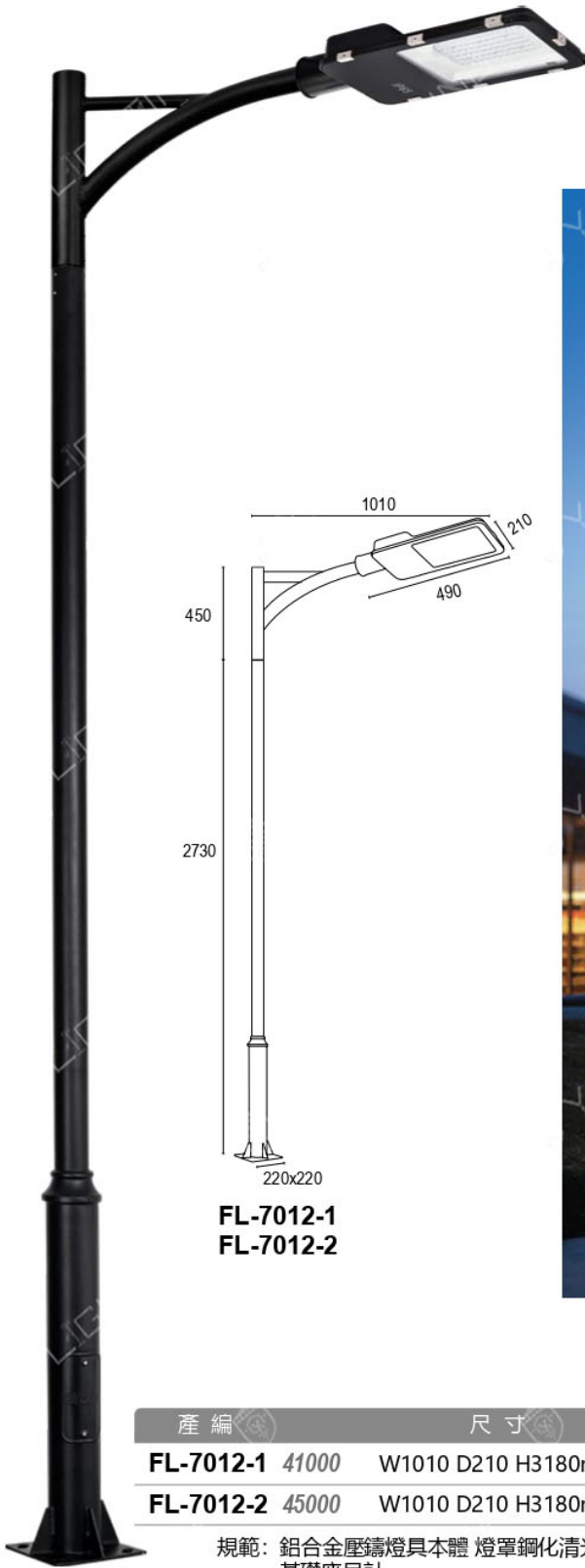

產編	尺寸	光源	電壓	材質
FL-7012-1 41000	W1010 D210 H3180mm	LED 40W PHILIPS 3000K	110V~220V	鋁材砂黑色
FL-7012-2 45000	W1010 D210 H3180mm	LED 60W PHILIPS 3000K		鋁材砂黑色

規範: 鋁合金壓鑄燈具本體 燈罩鋼化清光玻璃 矽膠防水墊圈 燈桿鋼材高溫粉體烤漆砂黑色 IP65 管徑 60mm 基礎座另計

7012-1 飛利浦燈珠 東菱驅動 光源質保一年

7012-2 飛利浦燈珠 明緯驅動 光源質保一年

Therefore, in the design, we should consider both the condition limitation and the overall road block appearance, and the ultimate realization of the scheme is very good to meet the above conditions, and become a successful case of good integration with the urban block as a whole.

If you leave, you enter the market, and you are responsible for seclusion. It is fornilunce's philosophy of life to be quiet and have a good command of style.



FL-7013-1

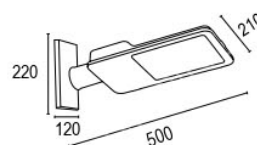

FL-7013-2

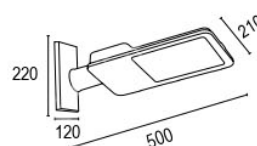

產編	尺寸	光源	電壓	材質
FL-7013-1 9800	W210 H220 D500mm	LED 40W PHILIPS 3000K	110V~220V	不銹鋼 + 鋁砂黑
FL-7013-2 14100	W210 H220 D500mm	LED 60W PHILIPS 3000K		不銹鋼 + 鋁砂黑

規範：鋁合金壓鑄燈具 本體燈罩鋼化清光玻璃 矽膠防水墊圈壁座 不銹鋼高溫粉體烤漆 IP65 光源質保一年

7013-1 飛利浦燈珠 東菱驅動 光源質保一年

7013-2 飛利浦燈珠 明緯驅動 光源質保一年

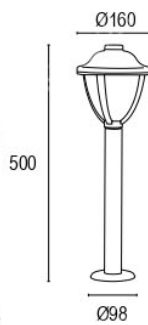

FL-7014-1

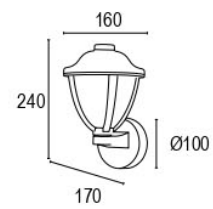

FL-7014-2

產 編	尺 寸	光 源	電 壓	材 質
FL-7014-1 7800	W160 H500mm	LED 11.7W 3000K	110V~220V	鋁 .PC 燈罩 烤漆砂黑
FL-7014-2 7200	W160 H240 D170mm	LED 11.7W 3000K		鋁 .PC 燈罩 烤漆砂黑

規範: 鋁合金壓鑄燈具本體 燈罩 PC 矽膠防水墊圈 壁座不銹鋼高溫粉體烤漆 IP65

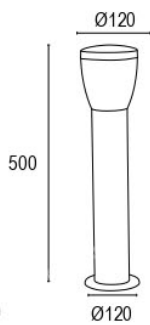
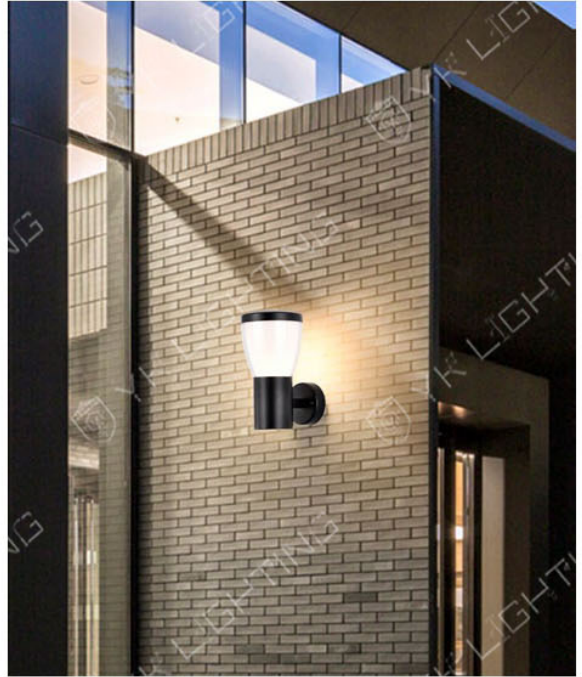

FL-7015-1

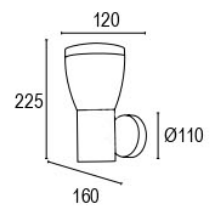

FL-7015-2

產編	尺寸	光源	電壓	材質
FL-7015-1 7000	W120 H500mm	LED 6.2W 3000K	110V~220V	不銹鋼.PC燈罩 烤漆砂黑
FL-7015-2 6000	W120 H225 D160mm	LED 6.2W 3000K		不銹鋼.PC燈罩 烤漆砂黑

規範：不銹鋼燈具本體 燈罩 PC 矽膠防水墊圈 壁座不銹鋼高溫粉體烤漆 IP65

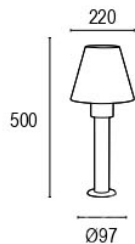

FL-7016-1

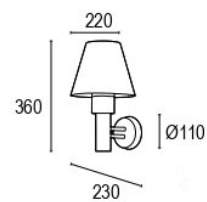

FL-7016-2

產 編	尺 寸	光 源	電 壓	材 質
FL-7016-1 8600	W220 H500mm	LED E27 雪糕燈泡 x1 另計	110V~220V	不銹鋼 鋁 PC 燈罩
FL-7016-2 8000	W220 H360 D230mm	LED E27 雪糕燈泡 x1 另計		烤漆砂黑 PC 燈罩

規範: 鋁合金壓鑄燈具本體 燈罩 PC 矽膠防水墊圈 壁座不銹鋼高溫粉體烤漆 IP65

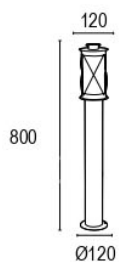

FL-7017-1

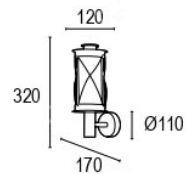

FL-7017-2

產 編	尺 寸	光 源	電 壓	材 質
FL-7017-1 7200	W120 H800mm	LED E27 燈泡 x1 另計	110V~220V	不銹鋼 PC 燈罩
FL-7017-2 5800	W120 H320 D170mm	LED E27 燈泡 x1 另計		烤漆砂黑色

規範：不銹鋼本體 燈罩 PC 清光罩 矽膠防水墊圈 IP65

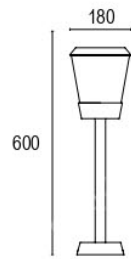

FL-7018-1

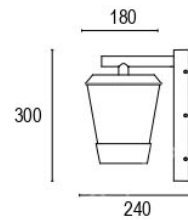

FL-7018-2

產 編	尺 寸	光 源	電 壓	材 質
FL-7018-1 10500	W180 H600mm	LED 13W 3000K	110V~220V	鋁材燈體 表面烤漆砂灰 + 清光 PC 罩
FL-7018-2 10500	W180 H300 D240mm	LED 13W 3000K		

規範：鋁合金壓鑄燈具本體 燈罩 PC 矽膠防水墊圈 高溫粉體烤漆 IP65

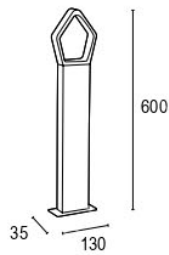

FL-7019-1

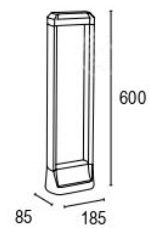
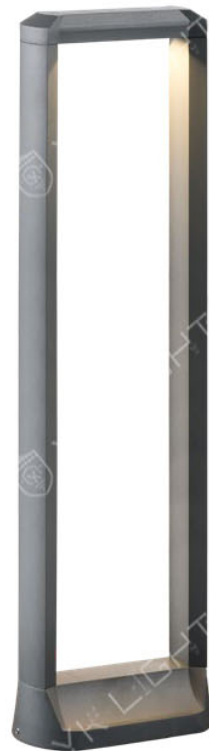

FL-7019-2

產編	尺寸	光源	電壓	材質
FL-7019-1 11200	W130 H600 D35mm	LED 7W 3000K	110V~220V	鋁材 砂灰色
FL-7019-2 9800	W185 H600 D85mm	LED 5W 3000K		鋁材 砂灰色

規範：型材鋁 高溫粉體烤漆 IP55



FL-7020-1



FL-7020-2

產 編	尺 寸	光 源	電 壓	材 質
FL-7020-1 7600	W150 H600mm	LED 7W 3000K	110V~220V	鋁材 砂黑色
FL-7020-2 9600	W165 H600mm	LED 7W 3000K		鋁材 砂黑色

規範：型材鋁 高溫粉體烤漆 IP55

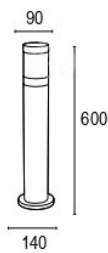

FL-7021-1

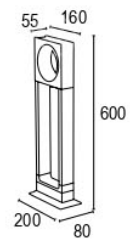

FL-7021-2

產編	尺寸	光源	電壓	材質
FL-7021-1 9800	W90 H600mm	LED 4W 3000K	110V~220V	鋁材 砂黑色 + 清光 PC 罩
FL-7021-2 8700	W160 H600 D55mm	SMD 12W 3000K		鋁材 砂黑色 + PC 罩

規範：型材鋁 高溫粉體烤漆 IP55



GardenLight series



The existence of lamps has changed the space.
 The shape of lamps is also a part of landscape design.
 Too ugly and too big lamps,
 Practical research is needed.
 I like to work hard on lamp modeling.
 The exposed must be beautiful and harmonious,
 Symbiosis with the environment.
 This is also the difference between my design and other designs.



FL-7023-1

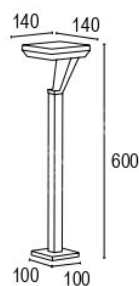

FL-7023-2

產 編	尺 寸	光 源	電 壓	材 質
FL-7023-1 6200	W140 H300 D140mm	LED 12W 3000K	110V~220V	鋁 .PC 燈罩 烤漆深灰
FL-7023-2 7800	W140 H600 D140mm	LED 12W 3000K		鋁 .PC 燈罩 烤漆深灰

規範：鋁合金壓鑄及鋁擠型燈具燈體 高溫粉體烤漆 IP55



FL-7024-1



FL-7024-2



FL-7024-3

產 編	尺 寸	光 源	電 壓	材 質
FL-7024-1 9800	W65 H780mm	LED 5W 3000K	110V~220V	壓鑄鋁砂灰色 + 壓克力
FL-7024-2 9300	W65 H600mm	LED 5W 3000K		壓鑄鋁砂灰色 + 壓克力
FL-7024-3 8500	W65 H430mm	LED 5W 3000K		壓鑄鋁砂灰色 + 壓克力

規範: 鋁合金壓鑄及鋁擠型燈具本體 矽膠防水墊圈 清光實心壓克力棒 高溫粉體烤漆 IP55

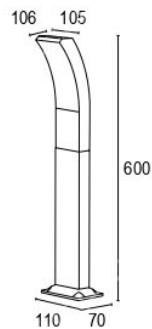

FL-7025-1

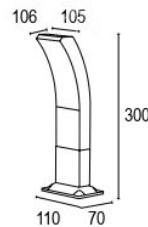

FL-7025-2

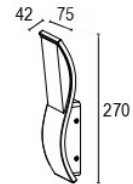

FL-7025-3

產 編	尺 寸	光 源	電 壓	材 質
FL-7025-1 6600	W105 H600 D106mm	SMD LED 12W 3000K		鋁 PC 燈罩烤漆砂黑
FL-7025-2 5100	W105 H300 D106mm	SMD LED 12W 3000K	110V~220V	鋁 PC 燈罩烤漆砂黑
FL-7025-3 5100	W75 H270 D42mm	LED 7W 3000K		鋁 PC 燈罩烤漆砂黑

規範：鋁合金壓鑄及鋁擠型燈具本體 矽膠防水墊圈 高溫粉體烤漆 IP55

Fornikace

Garden Light series

The existence of lamps has changed the space.
The shape of lamps is also a part of landscape design.
Too ugly and too big lamps,
Practical research is needed.
I like to work hard on lamp modeling.
The exposed must be beautiful and harmonious,
Symbiosis with the environment.
This is also the difference between my design and other designs.



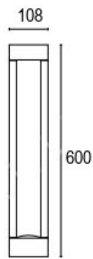

FL-7027-1

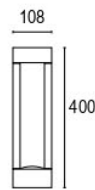

FL-7027-2

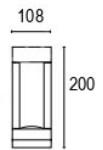

FL-7027-3

產 編	尺 寸	光 源	電 壓	材 質
FL-7027-1 6000	W108 H600mm	COB 10W 3000K	110V~220V	壓鑄鋁砂黑色
FL-7027-2 5400	W108 H400mm	COB 10W 3000K		壓鑄鋁砂黑色
FL-7027-3 4400	W108 H200mm	COB 10W 3000K		壓鑄鋁砂黑色

規範：鋁合金壓鑄及鋁擠型燈具本體 矽膠防水墊圈 高溫粉體烤漆 IP55

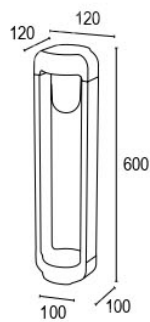

FL-7028-1

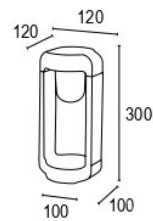

FL-7028-2

產 編	尺 寸	光 源	電 壓	材 質
FL-7028-1 9000	W120 H600 D120mm	E27 雪糕燈泡 x 1 另計	110V~220V	鋁 奶白 PC 砂黑
FL-7028-2 6500	W120 H300 D120mm	E27 雪糕燈泡 x 1 另計		鋁 奶白 PC 砂黑

規範：鋁合金壓鑄及鋁擠型燈具本體 矽膠防水墊圈 高溫粉體烤漆 IP55

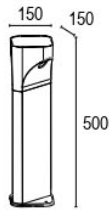

FL-7029-1

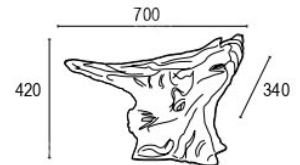

FL-7029-2

產 編	尺 寸	光 源	電 壓	材 質
FL-7029-1 10500	W150 H500 D150mm	LED 11W 3000K	110V~220V	鋁材 砂灰色
FL-7029-2 19800	W700 H420 D340mm	E27 LED x 1 另計		玻璃鋼

規範：鋁合金壓鑄及鋁擠型燈具本體 矽膠防水墊圈 高溫粉體烤漆 IP55

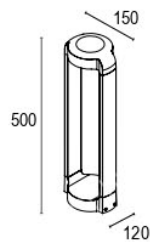

FL-7030-1

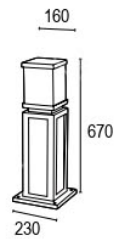

FL-7030-2

產 編	尺 寸	光 源	電 壓	材 質
FL-7030-1 10500	W150 H500 D120mm	LED 13W 3000K	110V~220V	鋁材 砂灰色
FL-7030-2 13000	W230 H670 D160mm	E27 LED x2 另計		鋁材 砂黑色 壓克力乳白罩

規範：鋁合金壓鑄及鋁擠型燈具本體 矽膠防水墊圈 高溫粉體烤漆 IP55



Therefore, in the design, we should consider both the condition limitation and the overall road block appearance, and the ultimate realization of the scheme is very good to meet the above conditions, and become a successful case of good integration with the urban block as a whole.

If you leave, you enter the market, and you are responsible for seclusion. It is fornilunce's philosophy of life to be quiet and have a good command of style.



產 編	尺 寸	光 源	電 壓	材 質
FL-7031-1 11600	W200 H600mm	E27 LEDx1 另計		鋁材砂黑色 + 玻璃
FL-7031-2 11600	W250 H740mm	E27 LEDx1 另計	110V~220V	鋁材砂黑色 + 玻璃
FL-7031-3 7800	W180 H790mm	E27 LEDx1 另計		鋁材平光黑描金 + 玻璃

規範：鋁合金壓鑄及鋁擠型燈具燈體 矽膠防水墊圈 高溫粉體烤漆 IP55

Therefore, in the design, we should consider both the condition limitation and the overall road block appearance, and the ultimate realization of the scheme is very good to meet the above conditions, and become a successful case of good integration with the urban block as a whole.

If you leave, you enter the market, and you are responsible for seclusion. It is fornilunce's philosophy of life to be quiet and have a good command of style.

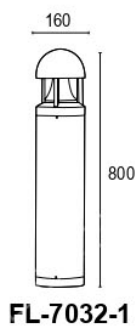

FL-7032-1

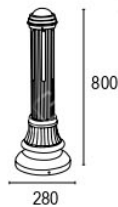

FL-7032-2

產編	尺寸	光源	電壓	材質
FL-7032-1 12000	Ø160 H800mm	E27 LEDx1 另計	110V~220V	鋁材 砂灰色
FL-7032-2 14600	Ø280 H800mm	E27 LEDx1 另計		鋁材 砂黑色 壓克力

規範：翻砂鑄鋁 PC罩 高溫粉體烤漆 IP55

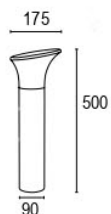

FL-7033-1

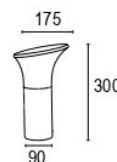

FL-7033-2

產 編	尺 寸	光 源	電 壓	材 質
FL-7033-1 6000	Ø175 H500mm	E27 LEDx1 另計	110V~220V	鋁材 砂灰色 +PC
FL-7033-2 4600	Ø175 H300mm	E27 LEDx1 另計		鋁材 砂灰色 +PC

規範：鋁合金壓鑄及鋁擠型燈具本體 高溫粉體烤漆 IP55

Therefore, in the design, we should consider both the condition limitation and the overall road block appearance, and the ultimate realization of the scheme is very good to meet the above conditions, and become a successful case of good integration with the urban block as a whole.

If you leave, you enter the market, and you are responsible for seclusion. It is fornilunce's philosophy of life to be quiet and have a good command of style.



產編	尺寸	光源	電壓	材質
FL-7034-1 6200	Ø100 H600mm	E27 LEDx1 另計	110V~220V	鋁材 砂灰色 + 玻璃燈罩
FL-7034-2 10500	Ø95 H520mm	LED 7W 3000K		鋁材砂銀色 + 玻璃燈罩

規範：鋁合金壓鑄及鋁擠型燈具本體 高溫粉體烤漆 IP55



產 編	尺 寸	光 源	電 壓	材 質
FL-7035-1 2900	Ø110 H360mm	E27 LEDx1 另計	110V~220V	鋁材砂黑色 + 玻璃燈罩
FL-7035-2 3800	Ø110 H460mm	E27 LEDx1 另計		鋁材砂黑色 + 玻璃燈罩
FL-7035-3 13500	Ø160 H600mm	E27 LEDx1 另計		鋁材砂灰色 + PC 燈罩

規範：鋁合金壓鑄及鋁擠型燈具本體 高溫粉體烤漆 IP55



FL-7036-1

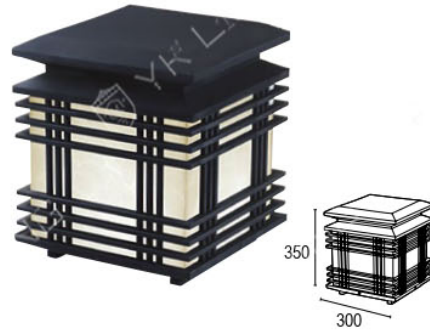

FL-7036-2



FL-7036-3

產 編	尺 寸	光 源	電 壓	材 質
FL-7036-1 30000	W380 H550mm	E27 LEDx1 另計		不銹鋼砂黑色 + 人造石
FL-7036-2 23000	W300 H350mm	E27 LEDx1 另計	110V~220V	不銹鋼砂黑色 + 人造石
FL-7036-3 17000	W300 H400mm	E27 LEDx1 另計		不銹鋼砂黑色 + 鋼化玻璃

規範: 不銹鋼燈具燈體 高溫粉體烤漆砂黑色 IP55

Therefore, in the design, we should consider both the condition limitation and the overall road block appearance, and the ultimate realization of the scheme is very good to meet the above conditions, and become a successful case of good integration with the urban block as a whole.

If you leave, you enter the market, and you are responsible for seclusion. It is fornillunce's philosophy of life to be quiet and have a good command of style.



FL-7037-1



FL-7037-2

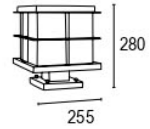

FL-7037-3

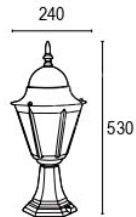

FL-7037-4



產 編	尺 寸	光 源	電 壓	材 質
FL-7037-1	17000 W255 H465mm	E27 LEDx1 另計	110V~220V	不銹鋼砂黑色 + 鋼化玻璃
FL-7037-2	12000 W255 H280mm	E27 LEDx1 另計		不銹鋼砂黑色 + 鋼化玻璃
FL-7037-3	2900 Ø240 H530mm	E27 LEDx1 另計		PC
FL-7037-4	8000 Ø230 H550mm	E27 LEDx1 另計		鋁材 + 玻璃

規範：不銹鋼燈具燈體 鋼化酸洗玻璃 高溫粉體烤漆砂黑色 IP55

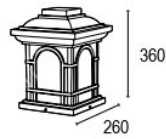

FL-7038-1

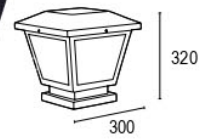

FL-7038-2

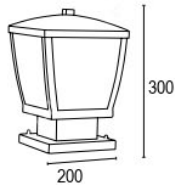

FL-7038-3

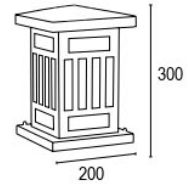

FL-7038-4

產 編	尺 寸	光 源	電 壓	材 質
FL-7038-1 14600	W260 H360mm	E27 LEDx1 另計	110V~220V	不銹鋼砂黑色 + 玻璃
FL-7038-2 12000	W300 H320mm	E27 LEDx1 另計		不銹鋼砂黑色 + 玻璃
FL-7038-3 9400	W200 H300mm	E27 LEDx1 另計		不銹鋼砂黑色 + 人造石
FL-7038-4 14200	W200 H300mm	E27 LEDx1 另計		不銹鋼砂黑色 + 人造石

規範：不銹鋼燈具燈體 高溫粉體烤漆 IP55

The existence of lamps has changed the space.
 The shape of lamps is also a part of landscape design.
 Too ugly and too big lamps,
 Practical research is needed.
 I like to work hard on lamp modeling.
 The exposed must be beautiful and harmonious,
 Symbiosis with the environment.
 This is also the difference between
 my design and other designs.



FL-7039-1

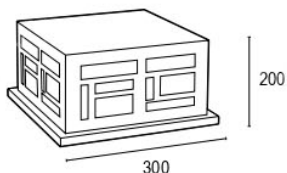

FL-7039-2

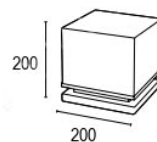

FL-7039-3

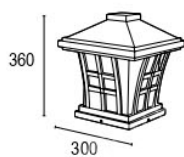

FL-7039-4

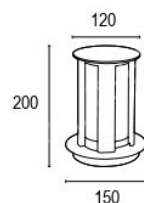

產 編	尺 寸	光 源	電 壓	材 質
FL-7039-1	14000 W300 H200mm	E27 LEDx1 另計	110V~220V	不銹鋼砂黑色 + 人造石
FL-7039-2	7400 W200 H200mm	E27 LEDx1 另計		不銹鋼砂黑色 + 人造石
FL-7039-3	14800 W300 H360mm	E27 LEDx1 另計		不銹鋼黑掃金 + 人造石
FL-7039-4	7000 上 W120 下 W150 H200mm	E27 LEDx1 另計		不銹鋼砂黑色 + 壓克力乳白燈罩

規範：不銹鋼燈具燈體 高溫粉體烤漆砂黑色 IP55



Therefore, in the design, we should consider both the condition limitation and the overall road block appearance, and the ultimate realization of the scheme is very good to meet the above conditions, and become a successful case of good integration with the urban block as a whole.

If you leave, you enter the market, and you are responsible for seclusion. It is fornilunce's philosophy of life to be quiet and have a good command of style.

It refers to the shape of the subject itself.

There are many kinds of customs, Still ugly, You can only know if you have seen it. This is the unfathomable place of the lighting industry.

One foot in heaven and one foot in hell. It needs a lot of observation, research and speculation to master

The exposed must be beautiful and harmonious, Symbiosis with the environment.

This is also the difference between my design and other designs.



FL-7040-1

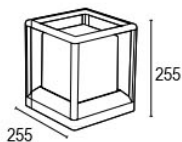

FL-7040-2

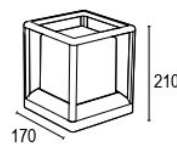

產 編	尺 寸	光 源	電 壓	材 質
FL-7040-1 7200	W255 H255mm	E27 LEDx1 另計	110V~220V	鋁材砂黑色 +PC 燈罩
FL-7040-2 5500	W170 H210mm	E27 LEDx1 另計		鋁材砂黑色 +PC 燈罩

規範: 鋁合金壓鑄及鋁擠型燈具本體 奶白 PC 燈罩 高溫粉體烤漆 IP55



FL-7041-1



FL-7041-2



FL-7041-3

產 編	尺寸	光 源	電 壓	材 質
FL-7041-1 4700	W170 H135mm	LED 12W 3000K	110V~220V	壓鑄鋁砂黑色 +PC 燈罩
FL-7041-2 4700	W160 H135mm	LED 12W 3000K		壓鑄鋁砂黑色 +PC 燈罩
FL-7041-3 16100	W300 H320mm	LED 20W 3000K		鋁材砂灰色 +PC 燈罩

規範：鋁合金壓鑄及鋁擠型燈具本體 PC 燈罩 高溫粉體烤漆 IP55

Fornitunce

Ceiling Light series



FL-7042-1

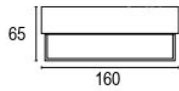

FL-7042-2



FL-7042-3

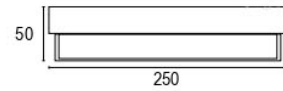

產編	尺寸	光源	電壓	材質
FL-7042-1 3000	W160 H65mm	SMD 12W 3000K	110V~220V	鋁材 PC 燈罩 烤漆砂黑
FL-7042-2 3000	W160 H65mm	SMD 12W 3000K		鋁材 PC 燈罩 烤漆砂黑
FL-7042-3 4200	W250 H50mm	SMD 20W 3000K		鋁材 PC 燈罩 烤漆砂黑

規範：鋁合金壓鑄及鋁擠型燈具本體 PC 燈罩 高溫粉體烤漆 IP55



FL-7043-1A
FL-7043-1B

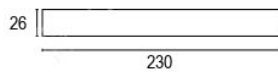

FL-7043-2A
FL-7043-2B
雷達感應燈



產 編	尺 寸	光 源	電 壓	材 質
FL-7043-1A	1400 W230 H26mm	LED 24W 3000K	110V~220V	PC 擴散板
FL-7043-1B	1400 W230 H26mm	LED 24W 4000K		PC 擴散板
FL-7043-2A	2800 W270 H85mm	LED 12W 6000K	110V~220V	壓克力燈罩
FL-7043-2B	2800 W270 H85mm	LED 12W 3000K		壓克力燈罩

規範：ABS 射出成型 / ABS 燈罩 雷達感應燈

Fornilunce

Ceiling Light series

Therefore, in the design, we should consider both the condition limitation and the overall road block appearance, and the ultimate realization of the scheme is very good to meet the above conditions, and become a successful case of good integration with the urban block as a whole.
If you leave, you enter the market, and you are responsible for seclusion. It is Fornilunce's philosophy of life to be quiet and have a good command of style.

The existence of lamps has changed the space.
 The shape of lamps is also a part of landscape design.
 Too ugly and too big lamps,
 Practical research is needed.
 I like to work hard on lamp modeling.
 The exposed must be beautiful and harmonious,
 Symbiosis with the environment.
 This is also the difference between
 my design and other designs.

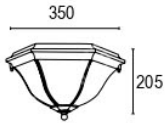

FL-7045-1

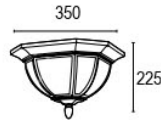

FL-7045-2



FL-7045-3

產 編	尺 寸	光 源	電 壓	材 質
FL-7045-1 6800	W350 H205mm	E27 LEDx2 另計		鋁材砂黑色 + 水紋玻璃
FL-7045-2 7200	W350 H225mm	E27 LEDx2 另計	110V~220V	鋁材平光黑 + 玻璃燈罩
FL-7045-3 4900	W330 H130mm	E27 LEDx2 另計		不銹鋼砂黑色 + 水紋玻璃

規範：1、2 鋁合金壓鑄燈具本體 燈罩強化打砂玻璃
 3 不銹鋼燈體 燈罩水紋玻璃

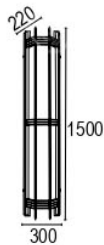

產 編	尺 寸	光 源	電 壓	材 質
FL-7046-1 訂製品	W300 H1500 D220mm	T5 LED 4 尺 x2 另計 E27x4 另計	110V~220V	不銹鋼砂黑 人造石

規範：不銹鋼燈具本體 人造石 高溫粉體烤漆

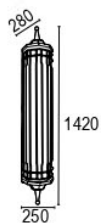
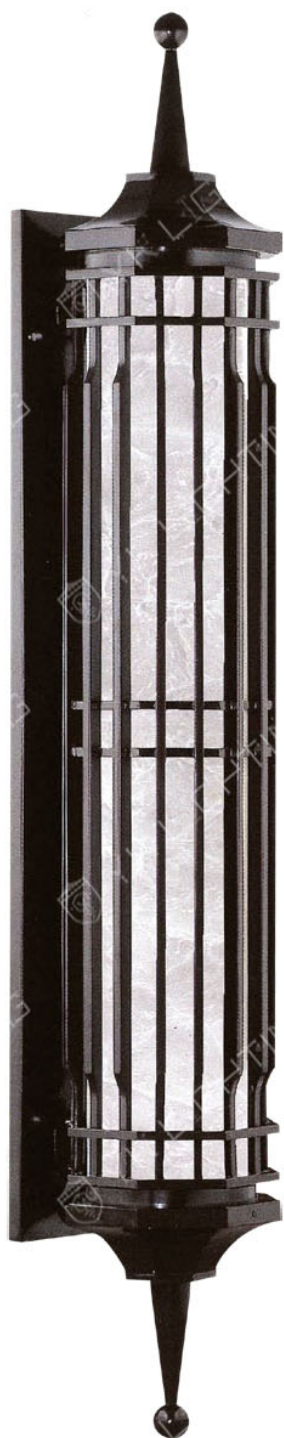

產 編	尺 寸	光 源	電 壓	材 質
FL-7047-1 69000	W250 H1420 D280mm	E27 LEDx3 另計 T5 3 尺 x2 另計	110V~220V	不銹鋼 黑咖啡色 人造石

規範：不銹鋼燈具本體 人造石 高溫粉體烤漆

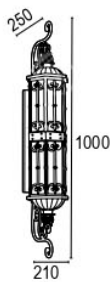

FL-7048-1

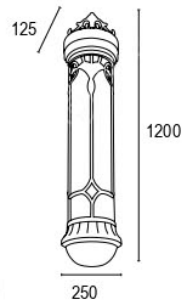

FL-7048-2

產編	尺寸	光源	電壓	材質
FL-7048-1 32000	W210 H1000 D250mm	E27 LEDx2 另計	110V~220V	壓鑄鋁黑掃金 + 仿古安全玻璃
FL-7048-2 24500	W250 H1200 D125mm	T5 LED 90CMx2 另計 E27 LED x 4 另計		鋁材框 不銹鋼壁座 人造石

規範：鋁合金壓鑄燈具本體 高溫粉體烤漆

The existence of lamps has changed the space.
 The shape of lamps is also a part of landscape design.
 Too ugly and too big lamps,
 Practical research is needed.
 I like to work hard on lamp modeling.
 The exposed must be beautiful and harmonious,
 Symbiosis with the environment.
 This is also the difference between
 my design and other designs.



FL-7049-1



FL-7049-2

產 編	尺 寸	光 源	電 壓	材 質
FL-7049-1	27000 W240 H1000 D150mm	E27 LEDx3 另計 / T5 x2 另計	110V~220V	不銹鋼砂黑色 人造石
FL-7049-2	23000 W280 H1080 D140mm	E27 LEDx4 另計		不銹鋼砂黑色 人造石

規範: 不銹鋼燈具本體 高溫粉體烤漆

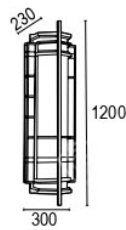

FL-7050-1

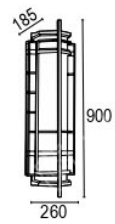

FL-7050-2

產 編	尺 寸	光 源	電 壓	材 質
FL-7050-1 37000	W300 H1200 D230mm	T5 LEDx2 另計	110V~220V	不銹鋼砂黑色 + 人造石
FL-7050-2 26000	W260 H900 D185mm	T5 LEDx2 另計		不銹鋼砂黑色 + 人造石

規範：不銹鋼燈具燈體 高溫粉體烤漆砂黑色

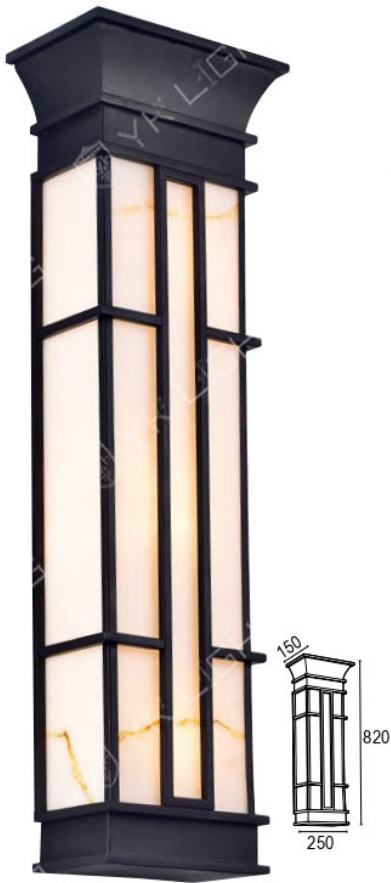

FL-7051-1



FL-7051-2

產 編	尺 寸	光 源	電 壓	材 質
FL-7051-1 19200	W250 H820 D150mm	E27 LEDx3+1 上方透光 另計	110V~220V	不銹鋼砂黑色 + 人造石
FL-7051-2 14000	W250 H620 D150mm	E27 LEDx2+1 上方透光 另計		不銹鋼砂黑色 + 人造石

規範：不銹鋼燈具燈體 高溫粉體烤漆

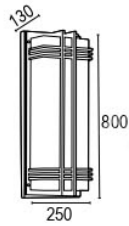

FL-7052-1

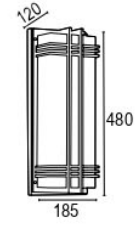

FL-7052-2

產 編	尺 寸	光 源	電 壓	材 質
FL-7052-1 18500	W250 H800 D130mm	T5 LEDx2 另計 / E27 LEDx3 另計	110V~220V	不銹鋼咖啡色 + 人造石
FL-7052-2 9600	W185 H480 D120mm	T5 LEDx2 另計 / E27 LEDx2 另計		不銹鋼咖啡色 + 人造石

規範：不銹鋼燈具燈體 高溫粉體烤漆

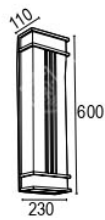

FL-7053-1

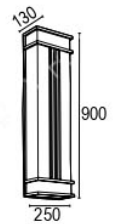

FL-7053-2

產 編	尺 寸	光 源	電 壓	材 質
FL-7053-1 13200	W230 H600 D110mm	E27 LEDx3 另計	110V~220V	不銹鋼砂黑色 + 人造石
FL-7053-2 18000	W250 H900 D130mm	E27 LEDx4 另計		不銹鋼砂黑色 + 人造石

規範：不銹鋼燈具燈體 高溫粉體烤漆

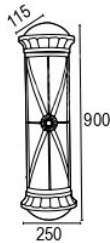

FL-7054-1

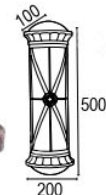

FL-7054-2

產編	尺寸	光源	電壓	材質
FL-7054-1 15500	W250 H900 D115mm	T5 LEDx2 另計 / E27 LEDx3 另計	110V~220V	鋁材黑掃金 + 人造石
FL-7054-2 8500	W200 H500 D100mm	T5 LEDx2 另計 / E27 LEDx2 另計		鋁材黑掃金 + 人造石

規範：鋁合金壓鑄燈具本體 高溫粉體烤漆

The existence of lamps has changed the space.
 The shape of lamps is also a part of landscape design.
 Too ugly and too big lamps,
 Practical research is needed.
 I like to work hard on lamp modeling.
 The exposed must be beautiful and harmonious,
 Symbiosis with the environment.
 This is also the difference between
 my design and other designs.

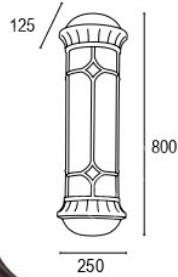

FL-7055-1

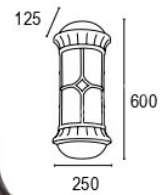

FL-7055-2

產 編	尺 寸	光 源	電 壓	材 質
FL-7055-1 18000	W250 H800 D125mm	T5 LEDx2/E27 LEDx3 另計	110V~220V	鋁材砂咖啡色 + 不銹鋼 + 人造石
FL-7055-2 14000	W250 H600 D125mm	T5 LEDx2/E27 LEDx2 另計		鋁材砂咖啡色 + 不銹鋼 + 人造石

規範：鋁合金壓鑄燈具本體 高溫粉體烤漆

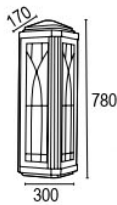

FL-7056-1

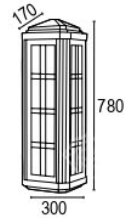

FL-7056-2

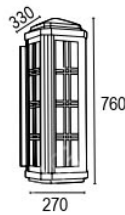

FL-7056-3

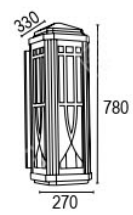

FL-7056-4

產 編	尺 寸	光 源	電 壓	材 質
FL-7056-1 22500	W300 H780 D170mm	T5 LEDx2 另計	110V~220V	不銹鋼砂黑色 + 人造石
FL-7056-2 22500	W300 H780 D170mm	T5 LEDx2 另計		不銹鋼砂黑色 + 人造石
FL-7056-3 24000	W270 H760 D330mm	T5 LEDx2 另計		不銹鋼砂黑色 + 人造石
FL-7056-4 24000	W270 H780 D330mm	T5 LEDx2 另計		不銹鋼砂黑色 + 人造石

規範: 不銹鋼燈具燈體 高溫粉體烤漆

The existence of lamps has changed the space.
 The shape of lamps is also a part of landscape design.
 Too ugly and too big lamps,
 Practical research is needed.
 I like to work hard on lamp modeling.
 The exposed must be beautiful and harmonious,
 Symbiosis with the environment.
 This is also the difference between
 my design and other designs.



FL-7057-1



FL-7057-2

產 編	尺 寸	光 源	電 壓	材 質
FL-7057-1 36000	W250 H1100 D350mm	E27 LEDx3+2 另計 上下透光	110V~220V	不銹鋼黑咖啡色 + 鋼化玻璃
FL-7057-2 16500	W250 H1000 D135mm	T5 LEDx2 另計 E27 LED x3+2 另計 上下透光		不銹鋼平光黑 + 鋼化玻璃

規範：不銹鋼燈具燈體 高溫粉體烤漆

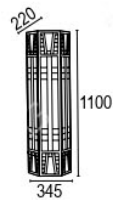

FL-7058-1

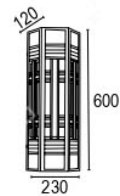

FL-7058-2

產編	尺寸	光源	電壓	材質
FL-7058-1 48000	W345 H1100 D220mm	E27 LEDx3+2 上下透光 另計	110V~220V	不銹鋼砂黑色 + 人造石
FL-7058-2 16000	W230 H600 D120mm	E27 LEDx2 另計		不銹鋼砂黑色 + 人造石

規範：不銹鋼燈具燈體 高溫粉體烤漆

The existence of lamps has changed the space.
 The shape of lamps is also a part of landscape design.
 Too ugly and too big lamps,
 Practical research is needed.
 I like to work hard on lamp modeling.
 The exposed must be beautiful and harmonious,
 Symbiosis with the environment.
 This is also the difference between
 my design and other designs.



FL-7059-1

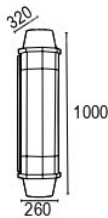

FL-7059-2

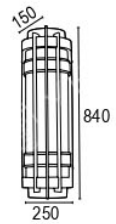

產 編	尺 寸	光 源	電 壓	材 質
FL-7059-1 31000	W260 H1000 D320mm	E27 LEDx2+2 上下透光 另計	110V~220V	不銹鋼黑咖啡色 + 人造石
FL-7059-2 25500	W250 H840 D150mm	T5 LED x2 另計 E27 LEDx2+2 另計 上下透光		不銹鋼黑咖啡掃金 + 人造石

規範：不銹鋼燈具燈體 高溫粉體烤漆

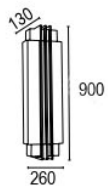

FL-7060-1

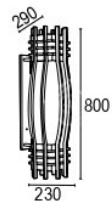

FL-7060-2

產編	尺寸	光源	電壓	材質
FL-7060-1 16000	W260 H900 D130mm	T5 LEDx2 另計 E27 LED x 3 另計	110V~220V	不銹鋼黑掃金 + 人造石
FL-7060-2 24000	W230 H800 D290mm	T5 LEDx2 另計上下 E27x1 另計		不銹鋼咖啡爆金 + 人造石

規範：不銹鋼燈具燈體 高溫粉體烤漆



FL-7061-1

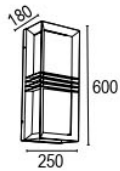

FL-7061-2

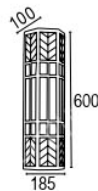

FL-7061-3

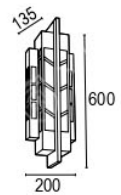

產 編	尺 寸	光 源	電 壓	材 質
FL-7061-1 16000	W250 H600 D180mm	E27 LEDx2 另計		不銹鋼 銀灰色 人造石
FL-7061-2 15000	W185 H600 D100mm	E27 LEDx2 另計	110V~220V	不銹鋼鐵灰色 人造石
FL-7061-3 15000	W200 H600 D135mm	T5 LED x 2 另計 E27 LEDx2 另計		不銹鋼咖啡金 人造石

規範：不銹鋼燈具燈體 高溫粉體烤漆



FL-7062-1

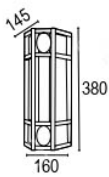

FL-7062-2

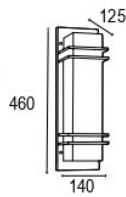

FL-7062-3

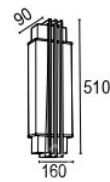

產 編	尺 寸	光 源	電 壓	材 質
FL-7062-1 5000	W160 H380 D145mm	E27 LEDx2 另計		不銹鋼 平光黑 鋼化玻璃
FL-7062-2 5800	W140 H460 D125mm	E27 LEDx2 另計	110V~220V	不銹鋼 深灰色 人造石
FL-7062-3 6200	W160 H510 D90mm	E27 LEDx2 另計		不銹鋼 黑掃金 鋼化玻璃

規範：不銹鋼燈具燈體 高溫粉體烤漆

The existence of lamps has changed the space.
 The shape of lamps is also a part of landscape design.
 Too ugly and too big lamps,
 Practical research is needed.
 I like to work hard on lamp modeling.
 The exposed must be beautiful and harmonious,
 Symbiosis with the environment.
 This is also the difference between
 my design and other designs.



FL-7063-1

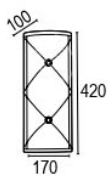

FL-7063-2

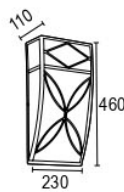

FL-7063-3

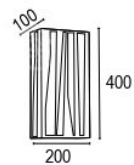

產 編	尺 寸	光 源	電 壓	材 質
FL-7063-1 5800	W170 H420 D100mm	E27 LEDx2 另計		不銹鋼 砂黑色 人造石
FL-7063-2 9800	W230 H460 D110mm	E27 LEDx2 另計	110V~220V	不銹鋼 咖啡金 人造石
FL-7063-3 7800	W200 H400 D100mm	E27 LEDx2 另計		不銹鋼 砂黑色 人造石

規範：不銹鋼燈具燈體 高溫粉體烤漆



FL-7064-1



FL-7064-2



FL-7064-3

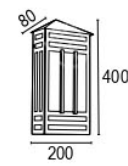

FL-7064-4

產 編	尺 寸	光 源	電 壓	材 質
FL-7064-1 16500	W230 H650 D130mm	T5 LED x2 另計 E27 LEDx2 另計	110V~220V	不銹鋼 咖啡金 人造石
FL-7064-2 14600	W220 H500 D130mm	T5 LED x2 另計 E27 LEDx2 另計		不銹鋼 咖啡金 玻璃
FL-7064-3 9600	W180 H400 D110mm	T5 LED x2 另計 E27 LEDx2 另計		不銹鋼 咖啡色 人造石
FL-7064-4 7200	W200 H400 D80mm	T5 LED x2 另計 E27 LEDx2 另計		不銹鋼 砂黑色 人造石

規範：不銹鋼燈具燈體 高溫粉體烤漆

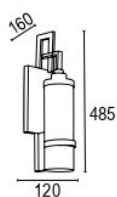

FL-7065-1

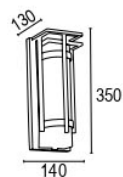

FL-7065-2

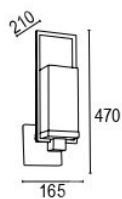

FL-7065-3

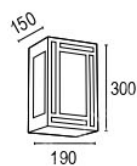

FL-7065-4

產 編	尺 寸	光 源	電 壓	材 質
FL-7065-1 9000	W120 H485 D160mm	E27 LED x1 另計	110V~220V	不銹鋼 砂黑色 玻璃罩
FL-7065-2 6800	W140 H350 D130mm	E27 LED x1 另計		不銹鋼 砂黑色 壓克力燈罩
FL-7065-3 7800	W165 H470 D210mm	E27 LED x1 另計		不銹鋼 砂黑色 人造石
FL-7065-4 6800	W190 H300 D150mm	E27 LED x1 另計		不銹鋼 深灰色 人造石

規範: 不銹鋼燈具燈體 高溫粉體烤漆



FL-7066-1

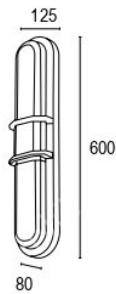

FL-7066-2

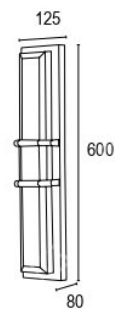

產編	尺寸	光源	電壓	材質
FL-7066-1 8200	W125 H600 D80mm	SMD 36W 3000K	110V~220V	鋁 PC 燈罩 烤漆砂黑
FL-7066-2 8200	W125 H600 D80mm	SMD 36W 3000K		鋁 PC 燈罩 烤漆砂黑

規範：壓鑄鋁燈具燈體 高溫粉體烤漆

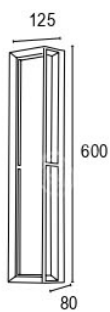

FL-7067-1

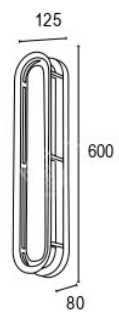

FL-7067-2

產 編	尺 寸	光 源	電 壓	材 質
FL-7067-1 8200	W125 H600 D80mm	SMD 36W 3000K	110V~220V	鋁 PC 燈罩 烤漆砂黑
FL-7067-2 8200	W125 H600 D80mm	SMD 36W 3000K		鋁 PC 燈罩 烤漆砂黑

規範：壓鑄鋁燈具燈體 高溫粉體烤漆



FL-7068-1

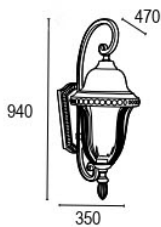

Therefore, in the design, we should consider both the condition limitation and the overall road block appearance, and the ultimate realization of the scheme is very good to meet the above conditions, and become a successful case of good integration with the urban block as a whole.

If you leave, you enter the market, and you are responsible for seclusion. It is fornilunce's philosophy of life to be quiet and have a good command of style. It refers to the shape of the subject itself.

產編	尺寸	光源	電壓	材質
FL-7068-1 23000	W350 H940 D470mm	E27 LEDx1 另計	110V~220V	鋁材棕紅色 清光玻璃燈罩

規範: 鋁合金壓鑄及鋁擠型燈具本體 玻璃燈罩 高溫粉體烤漆



FL-7069-2

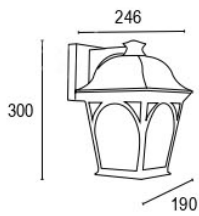

FL-7069-1

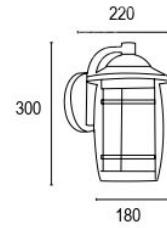

FL-7069-3

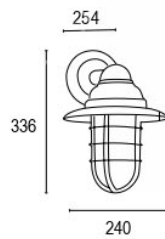

產 編	尺 寸	光 源	電 壓	材 質
FL-7069-1 6800	W180 H300 D220mm	E27 LEDx1 另計	110V~220V	鋁 玻璃 烤漆砂黑
FL-7069-2 6000	W190 H300 D246mm	E27 LEDx1 另計		鋁 玻璃 烤漆砂黑
FL-7069-3 6800	W240 H336 D254mm	E27 LEDx1 另計		鋁 玻璃 銀色仿古

規範：鋁合金壓鑄及鋁擠型燈具本體 玻璃燈罩 高溫粉體烤漆

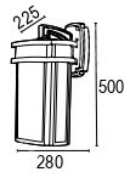

FL-7070-1



FL-7070-2



FL-7070-3

產 編	尺 寸	光 源	電 壓	材 質
FL-7070-1 19000	W280 H500 D225mm	E27 LEDx1 另計	110V~220V	鋁材 黑銀色 玻璃燈罩
FL-7070-2 11500	W235 H345 D190mm	E27 LEDx1 另計		鋁材 黑掃金 玻璃燈罩
FL-7070-3 9000	W195 H300 D175mm	E27 LEDx1 另計		鋁材 黑掃金 玻璃燈罩

規範：鋁合金壓鑄及鋁擠型燈具本體 高溫粉體烤漆



FL-7071-1

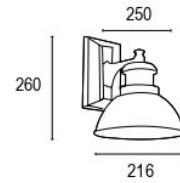

FL-7071-3

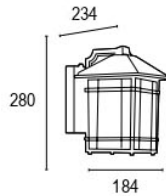

FL-7071-2



產 編	尺 寸	光 源	電 壓	材 質
FL-7071-1 5000	W216 H260 D250mm	E27 LEDx1 另計		鋁材 黑色仿古
FL-7071-2 7900	W200 H380 D235mm	E27 LEDx1 另計	110V~220V	鋁 玻璃 烤漆砂黑
FL-7071-3 6200	W184 H280 D234mm	E27 LEDx1 另計		鋁 玻璃 烤漆白色

規範：鋁合金壓鑄及鋁擠型燈具本體 玻璃燈罩 高溫粉體烤漆



FL-7072-1

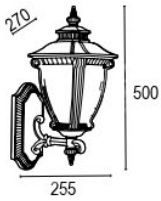

FL-7072-2

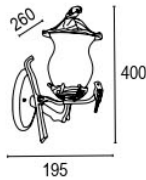

FL-7072-3

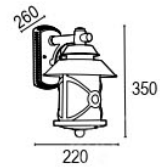

產 編	尺 寸	光 源	電 壓	材 質
FL-7072-1 8900	W255 H500 D270mm	E27 LEDx1 另計		鋁材 黑掃金 玻璃燈罩
FL-7072-2 7500	W195 H400 D260mm	E27 LEDx1 另計	110V~220V	鋁材 砂黑色 玻璃燈罩
FL-7072-3 7400	W220 H350 D260mm	E27 LEDx1 另計		鋁材 咖啡色 玻璃燈罩

規範：鋁合金壓鑄及鋁擠型燈具本體 玻璃燈罩 高溫粉體烤漆

Therefore, in the design, we should consider both the condition limitation and the overall road block appearance, and the ultimate realization of the scheme is very good to meet the above conditions, and become a successful case of good integration with the urban block as a whole.

If you leave, you enter the market, and you are responsible for seclusion. It is fornilunce's philosophy of life to be quiet and have a good command of style.



FL-7073-1

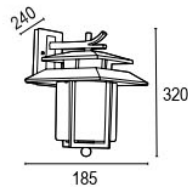

FL-7073-2

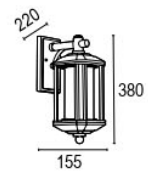

產 編	尺 寸	光 源	電 壓	材 質
FL-7073-1 5200	W185 H320 D240mm	E27 LEDx1 另計	110V~220V	鋁材 咖啡色 玻璃燈罩
FL-7073-2 6800	W155 H380 D220mm	E27 LEDx1 另計		鋁材 咖啡色 玻璃燈罩

規範: 鋁合金壓鑄及鋁擠型燈具本體 玻璃燈罩 高溫粉體烤漆

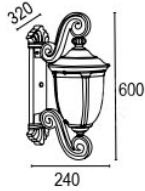

FL-7074-1



FL-7074-2



FL-7074-3



FL-7074-4

產編	尺寸	光源	電壓	材質
FL-7074-1 14200	W240 H600 D320mm	E27 LEDx1 另計	110V~220V	鋁材 平光黑掃金 玻璃燈罩
FL-7074-2 7500	W245 H540 D305mm	E27 LEDx1 另計		鋁材 砂黑色 氣泡玻璃燈罩
FL-7074-3 10000	W219 H400 D238mm	E27 LEDx1 另計		鋁材 砂黑色 氣泡玻璃燈罩
FL-7074-4 8600	W230 H500 D310mm	E27 LEDx1 另計		鋁材 水紋玻璃燈罩

規範：鋁合金壓鑄及鋁擠型燈具本體 玻璃燈罩 高溫粉體烤漆



FL-7075-1



FL-7075-2



FL-7075-3

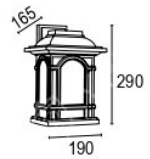

FL-7075-4

產 編	尺 寸	光 源	電 壓	材 質
FL-7075-1 11200	W240 H380 D265mm	E27 LEDx1 另計	110V~220V	EPMM 黑色 玻璃燈罩
FL-7075-2 8200	W200 H315 D225mm	E27 LEDx1 另計		EPMM 黑色 玻璃燈罩
FL-7075-3 8200	W241 H343 D200mm	E27 LEDx1 另計		EPMM 棕色 玻璃燈罩
FL-7075-4 6200	W190 H290 D165mm	E27 LEDx1 另計		EPMM 棕色 玻璃燈罩

規範: EPMM 射出燈體 玻璃燈罩

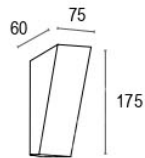

FL-7076-1

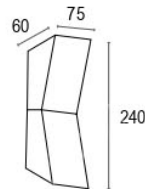

FL-7076-2

產編	尺寸	光源	電壓	材質
FL-7076-1 4600	W75 H175 D60mm	LED 3.5W 3000K	110V~220V	鋁材砂灰色
FL-7076-2 5600	W75 H240 D60mm	LED 6W 3000K		鋁材砂灰色

規範：鋁合金壓鑄及鋁擠型燈具燈體 高溫粉體烤漆 IP55

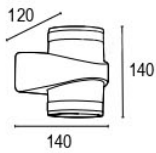

FL-7077-1

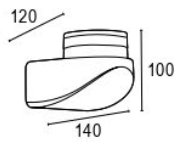

FL-7077-2

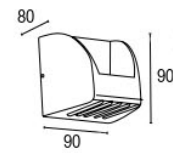

FL-7077-3

產 編	尺 寸	光 源	電 壓	材 質
FL-7077-1 5200	W140 H140 D120mm	LED COB 6Wx2 3000K	110V~220V	鋁材砂黑色 + 壓克力
FL-7077-2 4000	W140 H100 D120mm	LED COB 6Wx1 3000K		鋁材砂黑色 + 壓克力
FL-7077-3 3500	W90 H90 D80mm	LED 3Wx1 3000K		鋁材砂灰色

規範：鋁合金壓鑄及鋁擠型燈具燈體 高溫粉體烤漆 IP55

Fornikove

Outdoor wall light series

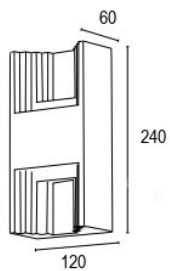
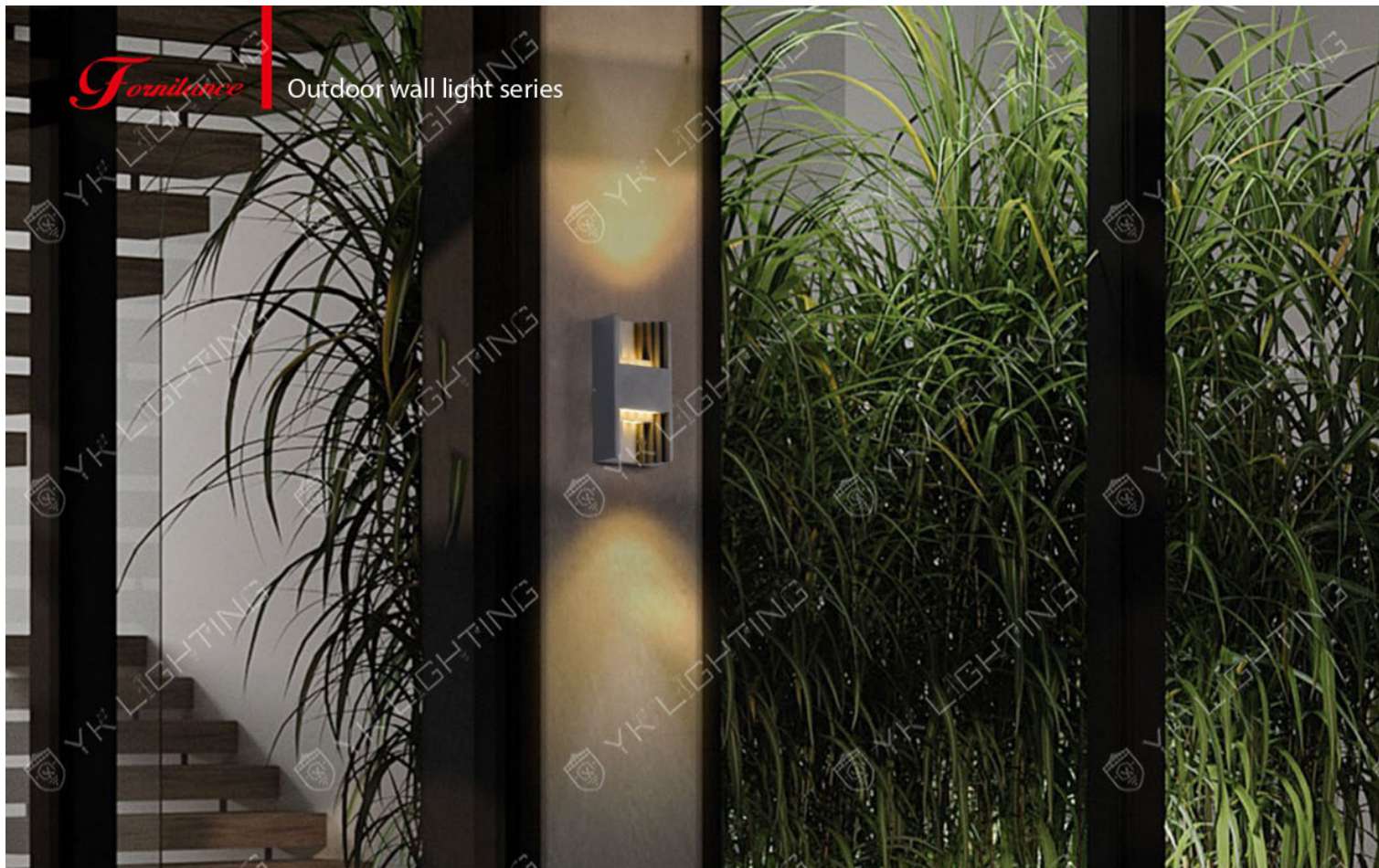

FL-7078-1

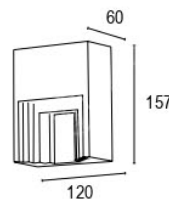

FL-7078-2

產編	尺寸	光源	電壓	材質
FL-7078-1 6400	W120 H240 D60mm	LED 7W x 2 3000K	110V~220V	鋁材砂灰色
FL-7078-2 5200	W120 H157 D60mm	LED 7W 3000K		鋁材砂灰色

規範：鋁合金壓鑄及鋁擠型燈具燈體 高溫粉體烤漆 IP55

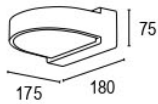
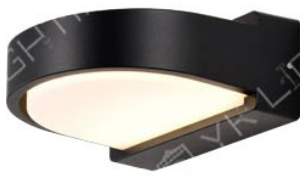

FL-7079-1

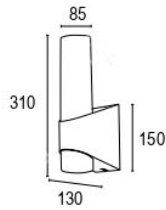

FL-7079-2

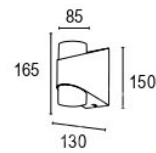

FL-7079-3

產 編	尺 寸	光 源	電 壓	材 質
FL-7079-1 6500	W180 H75 D175mm	LED 12.3W 3000K		鋁 PC 燈罩 烤漆砂黑
FL-7079-2 7100	W85 H310 D130mm	LED 11W 3000K	110V~220V	鋁 PC 燈罩 烤漆砂黑
FL-7079-3 6000	W85 H165 D130mm	LED 11W 3000K		鋁 PC 燈罩 烤漆砂黑

規範：鋁合金壓鑄及鋁擠型燈具燈體 高溫粉體烤漆 IP55



FL-7080-1

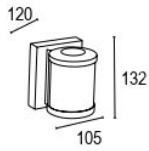

FL-7080-2

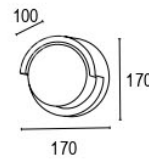

FL-7080-3

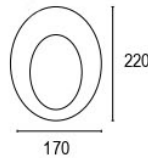

產 編	尺 寸	光 源	電 壓	材 質
FL-7080-1 3600	W105 H132 D120mm	LED 10W 3000K	110V~220V	鋁材砂黑色 + 壓克力
FL-7080-2 3800	W170 H170 D100mm	LED 12W 3000K		鋁材砂黑色 + 壓克力
FL-7080-3 5600	W170 H220 D55mm	LED 12W 3000K		鋁材石頭灰

規範：鋁合金壓鑄及鋁擠型燈具燈體 高溫粉體烤漆 IP55

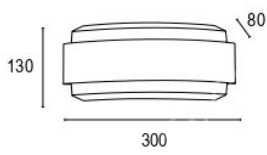

FL-7081-1

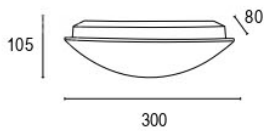

FL-7081-2

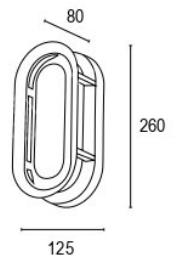

FL-7081-3

產 編	尺 寸	光 源	電 壓	材 質
FL-7081-1 4500	W300 H130 D80mm	SMD 6W x2 3000K	110V~220V	鋁 PC 燈罩 烤砂黑色
FL-7081-2 3600	W300 H105 D80mm	SMD 6W 3000K		鋁 PC 燈罩 烤砂黑色
FL-7081-3 4200	W125 H260 D80mm	SMD 12W 3000K		鋁 PC 燈罩 砂黑色 + 金

規範：鋁合金壓鑄及鋁擠型燈具燈體 高溫粉體烤漆 IP55



FL-7082-1



FL-7082-2

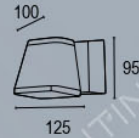

FL-7082-3



產 編	尺 寸	光 源	電 壓	材 質
FL-7082-1 6200	W180 H120 D225mm	LED 18W 3000K		鋁材石頭灰 +PC
FL-7082-2 4500	W125 H95 D100mm	LED 6+5W 3000K	110V~220V	鋁材石頭灰 +PC 上下透光
FL-7082-3 4800	W130 H125 D70mm	COB 5W x2 3000K		鋁材石頭灰

規範：鋁合金壓鑄及鋁擠型燈具燈體 高溫粉體烤漆 IP55

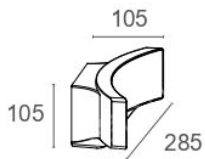

FL-7083-1

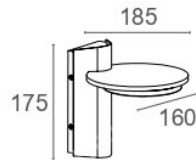

FL-7083-2

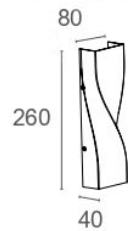

FL-7083-3

產 編	尺 寸	光 源	電 壓	材 質
FL-7083-1 9200	W285 H105 D105mm	LED 13W 3000K		鋁材 砂灰色 奶白燈罩
FL-7083-2 6850	W160 H175 D185mm	LED 13W 3000K	110V~220V	鋁材 砂灰色 PC 燈罩
FL-7083-3 5200	W80 H260 D40mm	LED 11W 3000K		鋁材 砂灰色

規範：鋁合金壓鑄及鋁擠型燈具燈體 高溫粉體烤漆 IP55

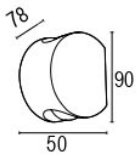

FL-7084-1

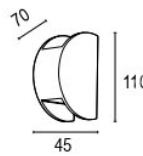

FL-7084-2

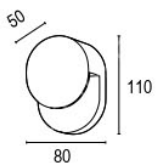

FL-7084-3

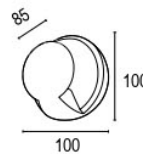

FL-7084-4

產 編	尺 寸	光 源	電 壓	材 質
FL-7084-1 5500	W50 H90 D78mm	LED 3W x 2 3000K	110V~220V	型材鋁 黑色
FL-7084-2 5200	W45 H110 D70mm	LED 3W x 2 3000K		型材鋁 砂灰色
FL-7084-3 8100	W80 H110 D50mm	LED 7W 3000K		型材鋁 砂白色
FL-7084-4 6500	W100 H100 D85mm	LED 7W 3000K		型材鋁 砂灰色

規範：鋁合金壓鑄及鋁擠型燈具燈體 高溫粉體烤漆 IP55



FL-7085-1

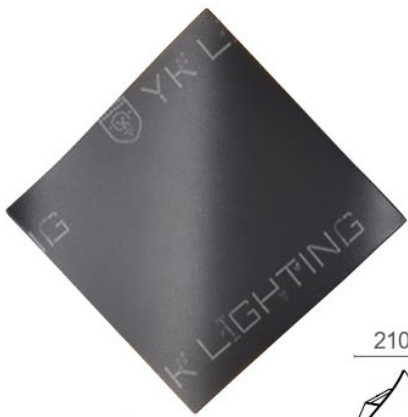
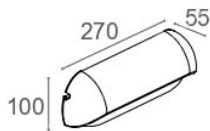

FL-7085-3

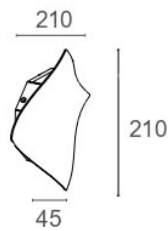

FL-7085-2

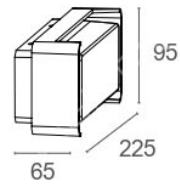

產 編	尺寸	光源	電 壓	材 質
FL-7085-1 6200	W270 H100 D55mm	LED 13W 3000K	110V~220V	鋁材 砂灰色 PC 燈罩
FL-7085-2 6200	W225 H95 D65mm	LED 13W 3000K		鋁材 砂灰色 PC 燈罩
FL-7085-3 5200	W210 H210 D45mm	LED 11W 3000K		鋁材 砂灰色

規範：鋁合金壓鑄及鋁擠型燈具燈體 高溫粉體烤漆 IP55

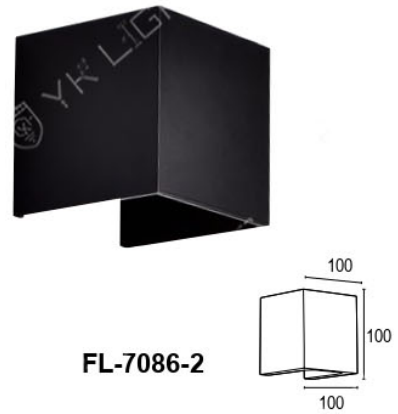
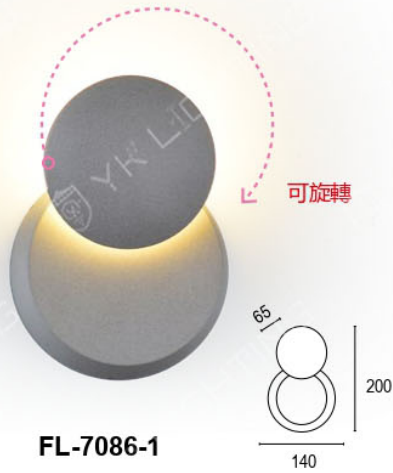

產 編	尺 寸	光 源	電 壓	材 質
FL-7086-1 4800	W140 H200 D65mm	LED 7W 3000K	110V~220V	鋁材 石頭灰 可旋轉
FL-7086-2 2250	W100 H100 D100mm	LED 3W x 2 3000K		鋁材 砂黑 可調整光線
FL-7086-3 5700	W60 H110 D60mm	LED 3W x 2 3000K		型材鋁 砂灰色 上下透光
FL-7086-4 2600	W68 H130 D61mm	LED 3W x 2 3000K		鋁材 黑 + 金 上下透光

規範：鋁合金壓鑄及鋁擠型燈具燈體 高溫粉體烤漆 IP55

The existence of lamps has changed the space.
 The shape of lamps is also a part of landscape design.
 Too ugly and too big lamps,
 Practical research is needed.
 I like to work hard on lamp modeling.
 The exposed must be beautiful and harmonious,
 Symbiosis with the environment.
 This is also the difference between
 my design and other designs.



FL-7087-1

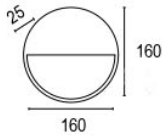

FL-7087-2

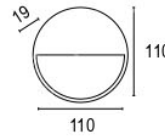

FL-7087-3

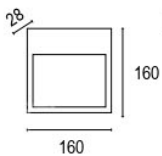

FL-7087-4

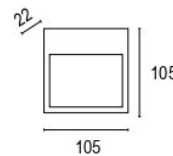

產 編	尺 寸	光 源	電 壓	材 質
FL-7087-1 3500	W160 H160 D25mm	LED 3W 3000K	110V~220V	鋁材石頭灰色
FL-7087-2 2900	W110 H110 D19mm	LED 2W 3000K		鋁材石頭灰色
FL-7087-3 3500	W160 H160 D28mm	LED 3W 3000K		鋁材石頭灰色
FL-7087-4 2900	W105 H105 D22mm	LED 2W 3000K		鋁材石頭灰色

規範：鋁合金壓鑄及鋁擠型燈具本體 高溫粉體烤漆 IP54



FL-7088-1

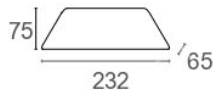

FL-7088-2

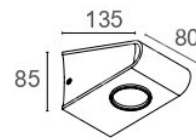

FL-7088-3



產編	尺寸	光源	電壓	材質
FL-7088-1 5900	W232 H75 D65mm	LED 9W 3000K	110V~220V	鋁材砂黑色 上下透光
FL-7088-2 6500	W80 H85 D135mm	LED 7W 3000K		鋁材 砂灰色
FL-7088-3 8800	W240 H130 D155mm	LED 13W 3000K		鋁材 砂黑色 PC 燈罩

規範：鋁合金壓鑄及鋁擠型燈具燈體 高溫粉體烤漆 IP55

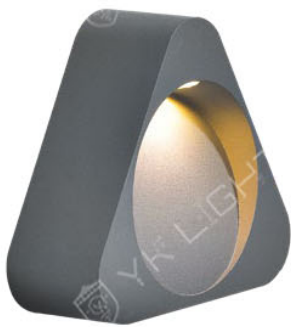

FL-7089-1

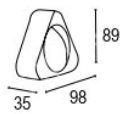

FL-7089-2

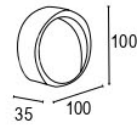

FL-7089-3

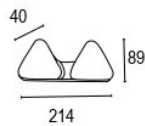

FL-7089-4

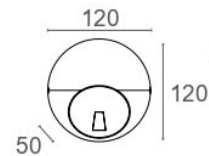

產編	尺寸	光源	電壓	材質
FL-7089-1 6500	W98 H89 D35mm	LED 3W 3000K	110V~220V	型材鋁 深灰色
FL-7089-2 6000	W100 H100 D35mm	LED 3W 3000K		型材鋁 深灰色
FL-7089-3 12500	W214 H89 D40mm	LED 2W x 4 3000K		型材鋁 深灰色
FL-7089-4 4600	W120 H120 D50mm	LED 3.5W 3000K		鋁材 砂黑色

規範：鋁合金壓鑄及鋁擠型燈具本體 高溫粉體烤漆 IP54



FL-7090-1

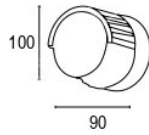

FL-7090-2

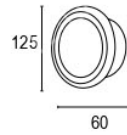

FL-7090-3

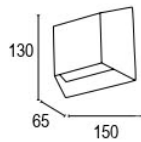

FL-7090-4

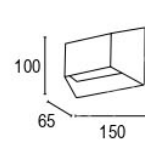

產編	尺寸	光源	電壓	材質
FL-7090-1 3200	W100 D90mm	SMD 6W 3000K	110V~220V	鋁 .PC 燈罩 烤漆砂黑 + 金
FL-7090-2 2600	W125 D60mm	LED 3W 3000K		鋁材 烤漆砂黑
FL-7090-3 3000	W150 H130 D65mm	SMD 7W x2 3000K		鋁材 烤漆砂黑
FL-7090-4 2600	W150 H100 D65mm	SMD 7W 3000K		鋁材 烤漆砂黑

規範：鋁合金壓鑄及鋁擠型燈具燈體 高溫粉體烤漆 IP55



FL-7091-1

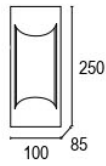

FL-7091-2

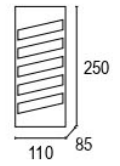

FL-7091-3

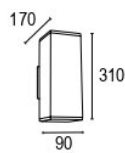

FL-7091-4

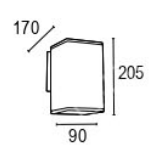

產 編	尺 寸	光 源	電 壓	材 質
FL-7091-1 3000	W100 H250 D85mm	E27 LED x1 另計	110V~220V	鋁 .PC 燈罩 烤漆砂黑
FL-7091-2 3000	W110 H250 D85mm	E27 LED x1 另計		鋁 .PC 燈罩 烤漆砂黑
FL-7091-3 2700	W90 H310 D170mm	E27 LED x2 另計		鋁材平光黑 + 強化玻璃
FL-7091-4 2100	W90 H205 D170mm	E27 LED x1 另計		鋁材平光黑 + 強化玻璃

規範：鋁合金壓鑄及鋁擠型燈具燈體 高溫粉體烤漆 IP55



FL-7092-1



FL-7092-2

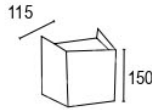

FL-7092-3

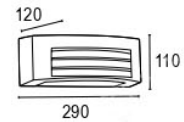

FL-7092-4

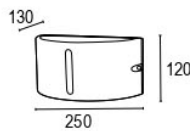

FL-7092-5

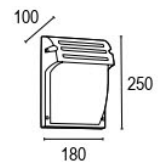

產 編	尺 寸	光 源	電 壓	材 質
FL-7092-1 4500	W190 H190 D120mm	LED 7W 3000K	110V~220V	鋁材 砂黑色 + 壓克力燈罩
FL-7092-2 4800	W150 H150 D115mm	LED 7W 3000K		鋁材 砂黑色 + 壓克力燈罩
FL-7092-3 2400	W290 H110 D120mm	E27 LED x 1 另計		鋁材 砂黑色 + 壓克力燈罩
FL-7092-4 2800	W250 H120 D130mm	E27 LED x 1 另計		鋁材 平光 PC 乳白罩
FL-7092-5 2300	W180 H250 D100mm	E27 LED x 1 另計		鋁材 砂黑色 玻璃燈罩

規範：鋁合金壓鑄及鋁擠型燈具燈體 高溫粉體烤漆 IP55



FL-7093-1

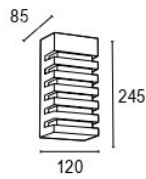

FL-7093-2

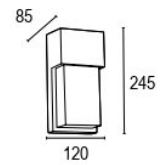

FL-7093-3

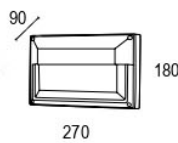

FL-7093-4

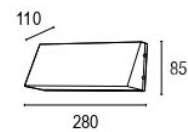

產 編	尺 寸	光 源	電 壓	材 質
FL-7093-1 3000	W120 H245 D85mm	E27 LED x 1 另計	110V~220V	鋁材 砂黑色 + 壓克力燈罩
FL-7093-2 3000	W120 H245 D85mm	E27 LED x 1 另計		鋁材 砂黑色 + 壓克力燈罩
FL-7093-3 3000	W270 H180 D90mm	E27 LED x 1 另計		鋁材 砂灰色 壓克力燈罩
FL-7093-4 3300	W280 H85 D110mm	E27 LED x 1 另計		鋁材 砂灰色 玻璃燈罩

規範：鋁合金壓鑄及鋁擠型燈具燈體 高溫粉體烤漆 IP55



FL-7094-1

2.4G PF RGB CCT 8分組遙控器



FL-7094-2

產 編	尺 寸	光 源	流 明	光 束 角	電 壓	材 質
FL-7094-1 2400	--	--	--	--	--	--
FL-7094-2 8200	W65 H275mm	2200K~6500K-7W	500~550Lm	25°	110V~220V	塑包鋁 透明防眩 PC

規範: 鋁合金壓鑄及鋁擠型燈具燈體 高溫粉體烤漆 IP65
質保二年

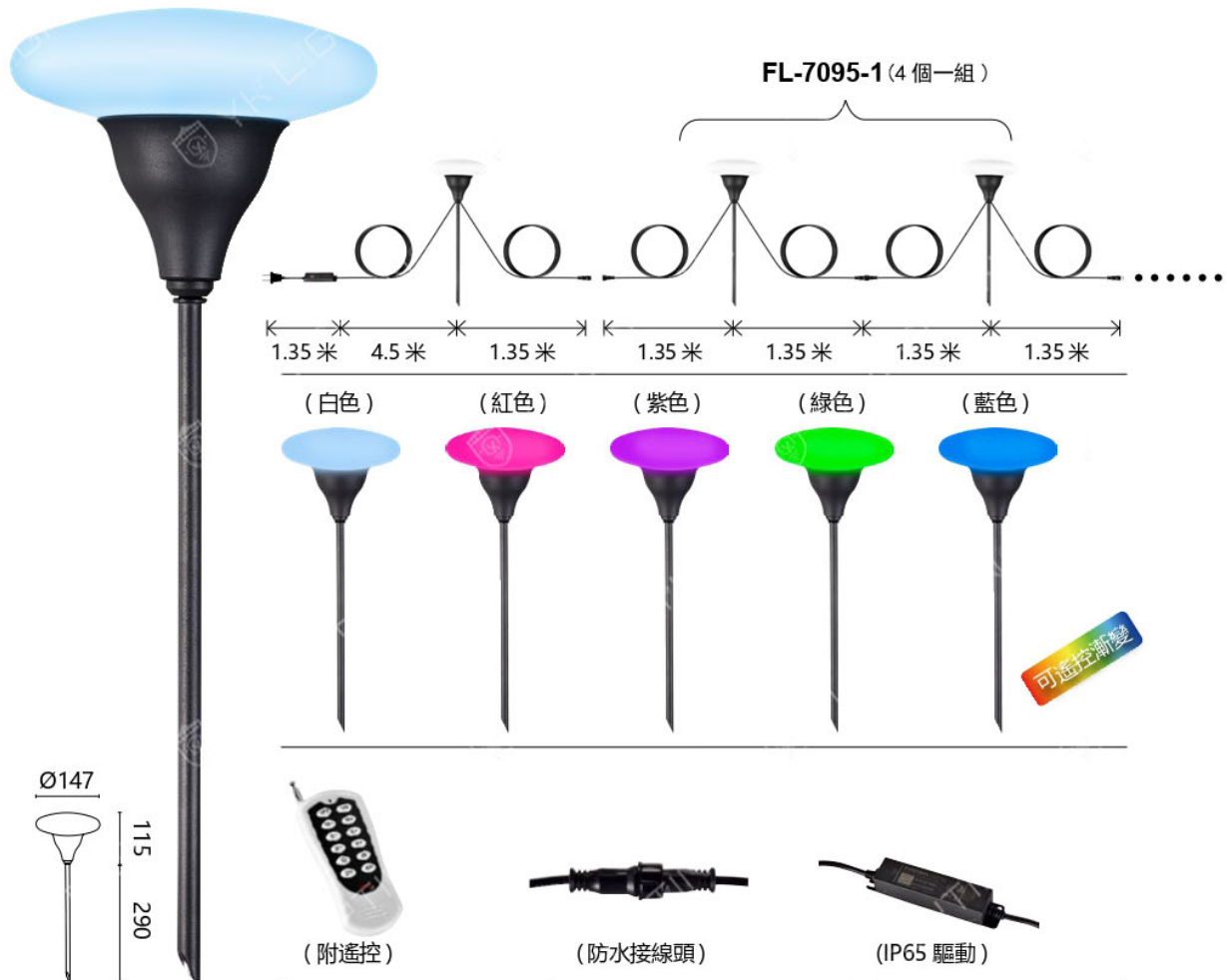

產 編	尺 寸	光 源	電 壓	材 質
FL-7095-1 21600	W147 H115 mm	LED 3Wx4 RGB 芯片	110V~220V	鋁材 + PC

規範: 插地棒 H290 帶防水電纜驅動 + 遙控器 IP65
 質保二年

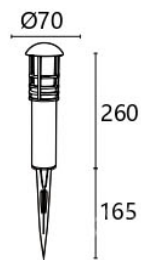

FL-7096-1

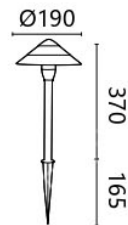

FL-7096-2

產編	尺寸	光源	電壓	材質
FL-7096-1 3400	W70 H260mm	LED 3W 3000K 驅動另計	DV12~24V	鋁材 棕色 PC 罩
FL-7096-2 3600	W190 H370mm	LED 3W 3000K 驅動另計		鋁 奶白 PC 黑色

規範：鋁合金壓鑄及鋁擠型燈具燈體 高溫粉體烤漆 IP55

If you leave, you enter the market, and you are responsible for seclusion. It is formlunce's philosophy of life to be quiet and have a good command of style. It refers to the shape of the subject itself.

There are many kinds of customs, Still ugly, You can only know if you have seen it. This is the unfathomable place of the lighting industry. One foot in heaven and one foot in hell. It needs a lot of observation, research and speculation to master

The exposed must be beautiful and harmonious, Symbiosis with the environment. This is also the difference between my design and other designs.



FL-7097-1

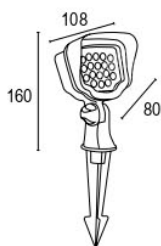

FL-7097-2

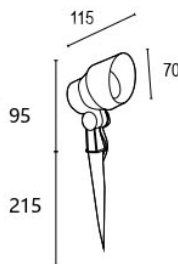

FL-7097-3

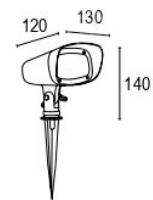

產 編	尺 寸	光 源	電 壓	材 質
FL-7097-1 4200	W108 H160 D80mm	LED 12W 3000K	DC12~24V 驅動另計	鋁材 砂黑色
FL-7097-2 3200	W70 H95 D115mm	LED 5W 3000K	DC12V 驅動另計	鋁材 棕色 玻璃燈罩
FL-7097-3 6300	W130 H140 D120mm	LED 12W 3000K	DC12V 驅動另計	鋁材 砂黑色 玻璃燈罩

規範：鋁合金壓鑄及鋁擠型燈具燈體 高溫粉體烤漆 IP55

Therefore, in the design, we should consider both the condition limitation and the overall road block appearance, and the ultimate realization of the scheme is very good to meet the above conditions, and become a successful case of good integration with the urban block as a whole.

If you leave, you enter the market, and you are responsible for seclusion.

It is fornilunce's philosophy of life to be quiet and have a good command of style.

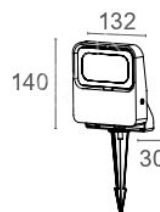
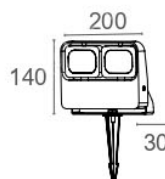
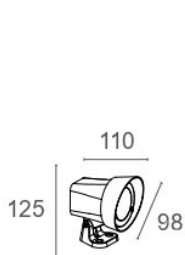

產 編	尺 寸	光 源	電 壓	材 質
FL-7098-1 5900	W98 H125 D110mm	LED 13W 3000K		鋁材 砂灰色
FL-7098-2 5900	W98 H314 D110mm	LED 13W 3000K		鋁材 砂灰色
FL-7098-3 9500	W98 H600 D110mm	LED 13W 3000K	110V~220V	鋁材 砂灰色
FL-7098-4 9800	W200 H140 D30mm	LED 12W 3000K		鋁材 砂黑色
FL-7098-5 7850	W132 H140 D30mm	LED 9W 3000K		鋁材 砂黑色

規範：鋁合金壓鑄及鋁擠型燈具燈體 高溫粉體烤漆 IP55



產 編	尺 寸	光 源	電 壓	材 質
FL-7099-1 2650	W47 H90 D85mm	LED 5W 3000K	110V~220V	鋁材 砂黑
FL-7099-2 4000	W60 H110 D105mm	LED 12W 3000K		鋁材 砂黑
FL-7099-3 5400	W80 H140 D135mm	LED 18W 3000K		鋁材 砂黑

規範：鋁合金壓鑄及鋁擠型燈具燈體 高溫粉體烤漆 IP55



附塑鋼插地棒



FL-7100-1



FL-7100-2



FL-7100-3



FL-7100-4



FL-7100-5

產編	尺寸	光源	電壓	材質
FL-7100-1 2800	W100 H140 D100mm	LED COB 7W 3000K	110V~220V	鋁材 砂黑色
FL-7100-2 3000	W100 H140 D100mm	LED COB 10W 3000K		鋁材 砂黑色
FL-7100-3 2800	W96 H110 D80mm	LED COB 7W 3000K		鋁材 砂黑色
FL-7100-4 4400	W140 H160 D140mm	LED COB 15W 3000K		鋁材 砂黑色
FL-7100-5 4500	W145 H170 D80mm	LED COB 15W 3000K		鋁材 砂黑色

規範：鋁合金壓鑄及鋁擠型燈具燈體 高溫粉體烤漆 IP55

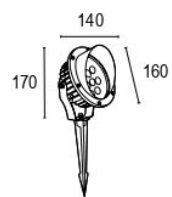

FL-7101-1

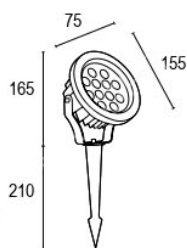

FL-7101-2

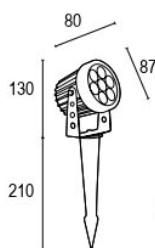

FL-7101-3

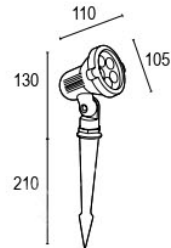

FL-7101-4

產 編	尺 寸	光 源	電 壓	材 質
FL-7101-1 4500	W160 H170 D140mm	LED 12W 3000K	110V~220V	鋁材 砂黑色
FL-7101-2 4500	W155 H165 D75mm	LED 12W 3000K		鋁材 砂黑色
FL-7101-3 2900	W87 H130 D80mm	LED 7W 3000K		鋁材 砂黑色
FL-7101-4 2700	W105 H130 D110mm	LED 5W 3000K		鋁材 砂黑色

規範：鋁合金壓鑄及鋁擠型燈具燈體 高溫粉體烤漆 IP55



FL-7102-1



FL-7102-2



FL-7102-3

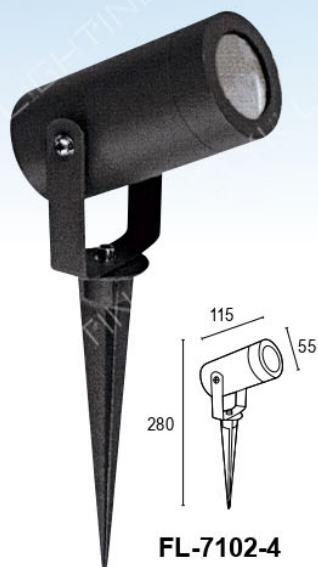

FL-7102-4



110mm

FL-7102-5



90mm

FL-7102-6

產編	尺寸	光源	電壓	材質
FL-7102-1 2600	W160 H360 D260mm	E27 LED x 1 另計		鋁材 砂黑色
FL-7102-2 3100	W160 H500 D240mm	E27 LED x 1 另計		鋁材 砂黑色
FL-7102-3 3100	W160 H500 D200mm	E27 LED x 1 另計	110V~220V	鋁材 砂黑色
FL-7102-4 3600	W55 H280mm	附 MR16 COB 5W 3000K		鋁材 砂黑色
FL-7102-5 600	W110	--	--	鋁材 砂黑色
FL-7102-6 600	W90	--	--	鋁材 砂黑色

規範：鋁合金壓鑄及鋁擠型燈具燈體 高溫粉體烤漆 IP55

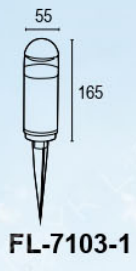

FL-7103-1



FL-7103-2

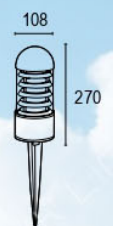

FL-7103-3



FL-7103-4



FL-7103-5

產 編	尺 寸	光 源	電 壓	材 質
FL-7103-1 2500	W55 H165mm	附 MR16 LED COB 5W x 1 3000K		鋁材 砂黑色 玻璃燈罩
FL-7103-2 2500	W65 H150mm	附 MR16 LED COB 5W x 1 3000K		鋁材 砂黑色 玻璃燈罩
FL-7103-3 2500	W108 H270mm	E27 LED x 1 另計	110V~220V	鋁材 砂黑色 玻璃燈罩
FL-7103-4 1800	W170 H300mm	E27 LED x 1 另計		PC 平光黑
FL-7103-5 2100	W240 H540mm	E27 LED x 1 另計		PC 平光黑

規範：鋁合金壓鑄及鋁擠型燈具燈體 高溫粉體烤漆 IP55



FL-7104-1

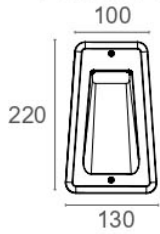

預埋盒尺寸:
W100 H200 D85



FL-7104-2

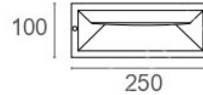

預埋盒尺寸:
W232 H80 D80

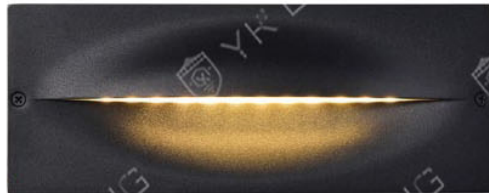

FL-7104-3

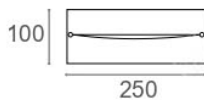

預埋盒尺寸:
W232 H80 D80



FL-7104-4

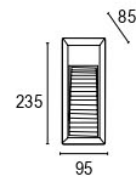

預埋盒尺寸:
W85 H225 D86

產編	尺寸	光源	電壓	材質
FL-7104-1 6850	W130 H220 D70mm	LED7W 3000K	110V~220V	鋁材 砂黑色 附預埋盒
FL-7104-2 5200	W250 H100 D70mm	LED 13W 3000K		鋁材 砂黑色 附預埋盒
FL-7104-3 5200	W250 H100 D70mm	LED 13W 3000K		鋁材 砂黑色 附預埋盒
FL-7104-4 3200	W95 H235 D85mm	LED 3W 3000K		鋁材 砂灰色 附預埋盒

規範: 鋁合金壓鑄及鋁擠型燈具燈體 高溫粉體烤漆 IP55



FL-7105-1

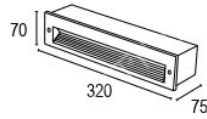

預埋盒尺寸: W312 H61 D68

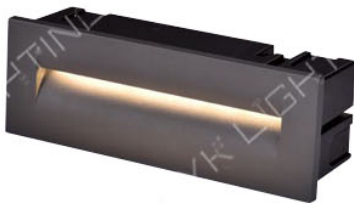

FL-7105-2

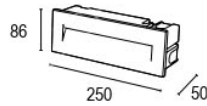

預埋盒尺寸: W240 H72 D65



FL-7105-3

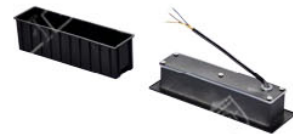
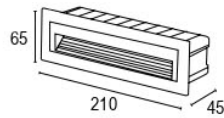

預埋盒尺寸: W200 H55 D55



FL-7105-4

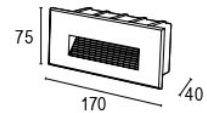

預埋盒尺寸: W160 H70 D50

產編	尺寸	光源	電壓	材質
FL-7105-1 5500	W320 H70 D75mm	LED 12W 3000K	110V~220V	鋁材 深灰色 附預埋盒
FL-7105-2 5200	W250 H86 D50mm	LED 10W 3000K		鋁材 烤漆砂灰 附預埋盒
FL-7105-3 2900	W210 H65 D45mm	LED 5W 3000K		鋁材 烤漆砂黑 附預埋盒
FL-7105-4 2600	W170 H75 D40mm	LED 5W 3000K		鋁材 砂黑色 附預埋盒

規範: 鋁合金壓鑄及鋁擠型燈具燈體 高溫粉體烤漆 IP55

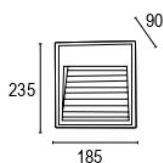

預埋盒尺寸: W180 H225 D96

FL-7106-1

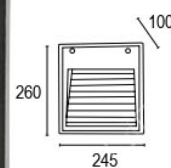

預埋盒尺寸: W220 H240 D110

FL-7106-2

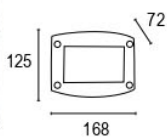

預埋盒尺寸: W160 H96 D75

FL-7106-3

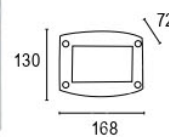

預埋盒尺寸: W160 H96 D75

FL-7106-4

產編	尺寸	光源	電壓	材質
FL-7106-1 5200	W185 H235 D90mm	LED 3W 3000K	110V~220V	鋁材 砂灰色 附預埋盒
FL-7106-2 6200	W245 H260 D100mm	E27 LED 雪糕燈泡 x 1 另計		鋁材 砂黑色 附預埋盒
FL-7106-3 2600	W168 H125 D72mm	附 LED G9 x 1 3000K		鋁材 砂灰色 附預埋盒
FL-7106-4 3700	W168 H130 D72mm	台製 LED5050 藍光 3W		鋁材 砂灰色 附預埋盒

規範: 鋁合金壓鑄及鋁擠型燈具燈體 高溫粉體烤漆 IP55



FL-7107-1

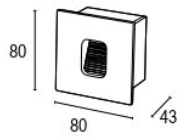

預埋盒尺寸: W63 H63 D45



FL-7107-2

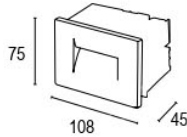

預埋盒尺寸: W98 H63 D45

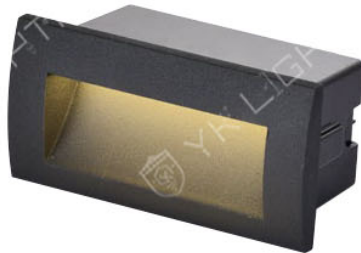

FL-7107-3

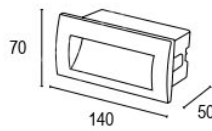

預埋盒尺寸: W125 H60 D60



FL-7107-4

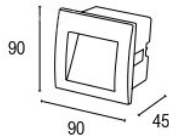

預埋盒尺寸: W80 H80 D60

產編	尺寸	光源	電壓	材質
FL-7107-1 3200	W80 H80 D43mm	LED 3W 3000K	110V~220V	鋁材 砂灰色 附預埋盒
FL-7107-2 3200	W108 H75 D45mm	LED 3W 3000K		鋁材 砂灰色 附預埋盒
FL-7107-3 3300	W140 H70 D50mm	LED 3W 3000K		鋁材 烤漆砂黑 附預埋盒
FL-7107-4 3100	W90 H90 D45mm	LED 2W 3000K		鋁材 烤漆砂黑 附預埋盒

規範: 鋁合金壓鑄燈具本體砂灰色 強化安全玻璃 矽膠防水墊圈 工程塑料預埋盒 高溫粉體烤漆 IP55



FL-7108-1

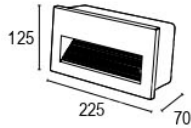

預埋盒尺寸: W210 H110 D80



FL-7108-2

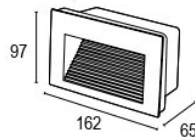

預埋盒尺寸: W155 H90 D75



FL-7108-3

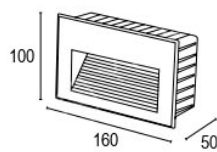

預埋盒尺寸: W155 H95 D55

產編	尺寸	光源	電壓	材質
FL-7108-1 3100	W225 H125 D70mm	LED 5W 3000K		鋁材 砂黑色 附預埋盒
FL-7108-2 2300	W162 H97 D65mm	LED 3W 3000K	110V~220V	鋁材 砂銀色 附預埋盒
FL-7108-3 2400	W160 H100 D50mm	LED 7W 3000K		鋁材 砂黑色 附預埋盒

規範: 鋁合金壓鑄及鋁擠型燈具燈體 高溫粉體烤漆 IP55



FL-7109-1

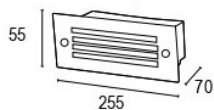

預埋盒尺寸: W245 H45 D80



FL-7109-2

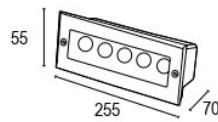

預埋盒尺寸: W245 H45 D80



FL-7109-3

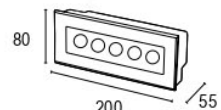

預埋盒尺寸: W185 H70 D65

產 編	尺 寸	光 源	電 壓	材 質
FL-7109-1 2600	W255 H55 D70mm	LED 5W 3000K	110V~220V	鋁材砂黑色 附預埋盒
FL-7109-2 2600	W255 H55 D70mm	LED 5W 3000K	110V~220V	鋁材砂黑色 附預埋盒
FL-7109-3 3800	W200 H80 D55mm	LED 5W 3000K	110V~220V	不銹鋼 附預埋盒

規範: 鋁合金壓鑄燈具本體 強化安全玻璃 矽膠防水墊圈 工程塑料預埋盒 高溫粉體烤漆 IP54

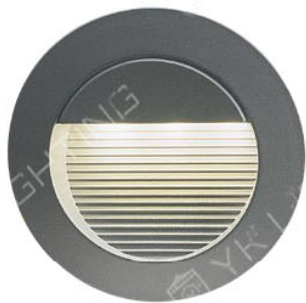

FL-7110-1

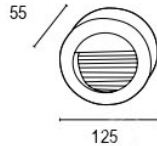

預埋盒尺寸: W115 D65



FL-7110-2

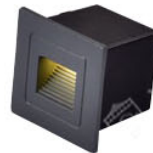
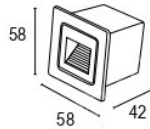

預埋盒尺寸: W45 H45 D45



FL-7110-3

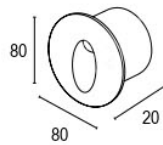

預埋盒尺寸: W60 H25



FL-7110-4

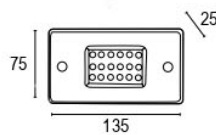

產 編	尺 寸	光 源	電 壓	材 質
FL-7110-1 2700	W125 H125 D55mm	LED 3W 3000K	110V~220V	鋁材 銀灰色 附預埋盒
FL-7110-2 1600	W58 H58 D42mm	LED 3W 3000K		鋁材 砂黑色 附預埋盒
FL-7110-3 2000	W80 H80 D20mm	LED 3W 3000K		鋁材 砂白色 附預埋盒
FL-7110-4 2000	W135 H75 D25mm	LED 18 顆 白光		不銹鋼 壓克力打砂 不附預埋盒

規範: 型材鋁 強化安全玻璃 塑料預埋盒 高溫粉體烤漆 IP54



FL-7111-1

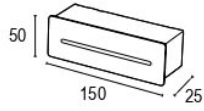

FL-7111-2

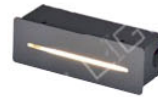
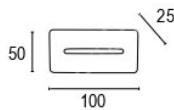

FL-7111-3

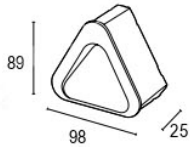

FL-7111-4

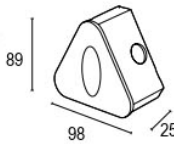

產編	尺寸	光源	電壓	材質
FL-7111-1	5600 W150 H50 D25mm	LED 3W 3000K	110V~220V	型材鋁 深灰色
FL-7111-2	4900 W100 H50 D25mm	LED 3W 3000K		型材鋁 深灰色
FL-7111-3	5700 W98 H89 D25mm	LED 3W 3000K	110V~220V	型材鋁 深灰色
FL-7111-4	5700 W98 H89 D25mm	LED 3W 3000K		型材鋁 深灰色

規範: 型材鋁 強化安全玻璃 鋼材預埋盒 高溫粉體烤漆 IP54



FL-7112-1



預埋盒尺寸: W75 H45



FL-7112-2

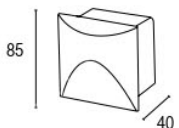

預埋盒尺寸: W75 H45

產 編	尺 寸	光 源	電 壓	材 質
FL-7112-1 1800	W85 D40mm	LED 3W 3000K	110V~220V	鋁烤漆砂黑 附預埋盒
FL-7112-2 1800	W85 D40mm	LED 3W 3000K		鋁烤漆砂黑 附預埋盒

規範: 型材鋁 強化安全玻璃 塑料預埋盒 高溫粉體烤漆 IP44



FL-7113-1

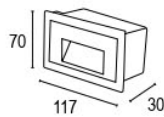

預埋盒尺寸: L105 W60 D50



台製預埋盒



FL-7113-2

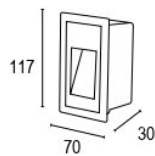

預埋盒尺寸: W60 H105 D50



台製預埋盒

產編	尺寸	光源	電壓	材質
FL-7113-1 2880	W117 H70 D30mm	LED 3W 3000K	110V~220V	鋁烤漆砂黑 附預埋盒
FL-7113-2 2880	W70 H117 D30mm	LED 3W 3000K		鋁烤漆砂黑 附預埋盒

規範: 型材鋁 強化安全玻璃 塑料預埋盒 高溫粉體烤漆 IP44

Forniluce

Underground light series



FL-7114-1
光感 + 人體感應

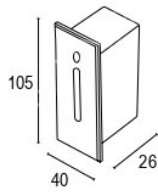

預埋盒尺寸: W33 H85 D45



FL-7114-2

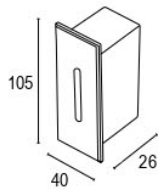

預埋盒尺寸: W33 H85 D45

產編	尺寸	光源	電壓	材質
FL-7114-1 2900	W40 H105 D26mm	LED 3W 3000K	110V~220V	鋁 拉絲黑 附預埋盒 附感應器
FL-7114-2 2200	W40 H105 D26mm	LED 3W 3000K		鋁 拉絲黑 附預埋盒

規範: 型材鋁 強化安全玻璃 鋼材預埋盒 高溫粉體烤漆 IP54



FL-7115-1

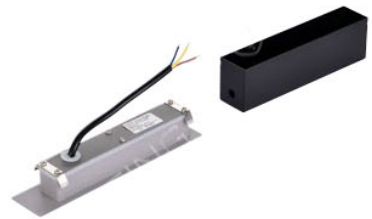
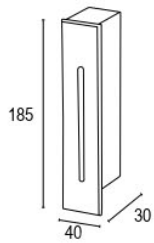

預埋盒尺寸: W35 H160 D45

產編	尺寸	光源	電壓	材質
FL-7115-1 2600	W40 H185 D30mm	LED 3W 3000K	110V~220V	鋁 烤漆銀灰 附預埋盒

規範: 型材鋁 強化安全玻璃 鋼材預埋盒 高溫粉體烤漆 IP54

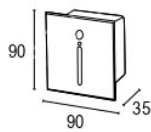

FL-7116-1

光感 + 人體感應

預埋盒尺寸: W80 H80 D50

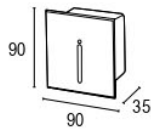

FL-7116-2

預埋盒尺寸: W80 H80 D50

產編	尺寸	光源	電壓	材質
FL-7116-1 3500	W90 H90 D35mm	LED 3W 3000K	110V~220V	鋁 拉絲灰 附預埋盒 附感應器
FL-7116-2 2500	W90 H90 D35mm	LED 3W 3000K		鋁 拉絲灰 附預埋盒

規範: 型材鋁 強化安全玻璃 塑料預埋盒 高溫粉體烤漆 IP54



FL-7117-1

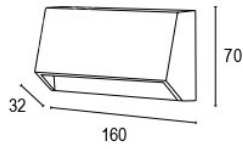

FL-7117-2

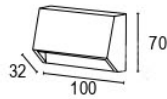

FL-7117-3

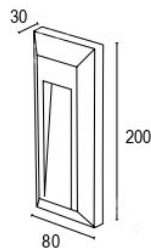

產 編	尺 寸	光 源	電 壓	材 質
FL-7117-1 2500	W160 H70 D32mm	LED 3W 3000K	110V~220V	PC 灰色 IP65
FL-7117-2 1800	W100 H70 D32mm	LED 1.5W 3000K		PC 灰色 IP65
FL-7117-3 2900	W80 H200 D30mm	LED 1W 3000K		PC 深灰色 IP65

規範：射出成型 PC IP65



FL-7118-1

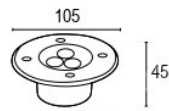

不附預埋盒



FL-7118-2

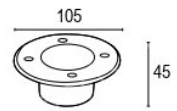

不附預埋盒



FL-7118-3

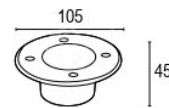

不附預埋盒



FL-7118-4

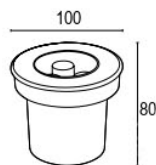

預埋盒尺寸：
W95 H80



FL-7118-5

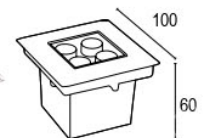

產 編	尺 寸	光 源	電 壓	材 質
FL-7118-1	2300 Ø105 H45mm	LED 3W 3000K	110V~220V	不銹鋼 不附預埋盒
FL-7118-2	2300 Ø105 H45mm	LED 3W 3000K		不銹鋼 不附預埋盒
FL-7118-3	2300 Ø105 H45mm	LED 3W 藍光		不銹鋼 不附預埋盒
FL-7118-4	2400 W100 H80mm	LED 3W 3000K		壓鑄鋁不銹鋼 附預埋盒
FL-7118-5	3000 W100 H60mm	LED 4W 3000K		壓鑄鋁不銹鋼 附預埋盒

規範: 304 不銹鋼面板 透明強化玻璃 鋁材燈體 矽膠防水墊圈 IP65



FL-7119-1

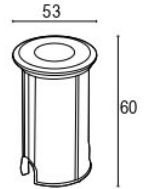

預埋盒尺寸:
W48 H75



FL-7119-2A
FL-7119-2B

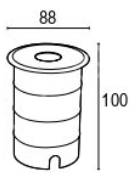

預埋盒尺寸:
W74 H115



FL-7119-3A
FL-7119-3B



預埋盒尺寸:
W48 H90



FL-7119-4

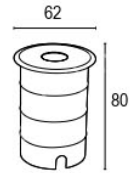

預埋盒尺寸:
W48 H90

產編	尺寸	光源	電壓	材質
FL-7119-1	2600 Ø53 H60	LED 1W 3000K	110V~220V	不銹鋼 附預埋盒
FL-7119-2A	4800 Ø88 H100mm	CREE LED 5W 3000K	110V~220V	不銹鋼 附預埋盒
FL-7119-2B	4800 Ø88 H100mm	CREE LED 5W 3000K	12V	不銹鋼 附預埋盒
FL-7119-3A	3800 Ø62 H80mm	CREE LED 3W 3000K	110V~220V	不銹鋼 附預埋盒
FL-7119-3B	3800 Ø62 H80mm	CREE LED 3W 3000K	12V	不銹鋼 附預埋盒
FL-7119-4	4200 Ø62 H80mm	CREE LED 3W 3000K	110V~220V	不銹鋼 + 水晶 附預埋盒

規範: 316不銹鋼面板 鋁材燈體 矽膠防水墊圈 鋁材蜂巢網 鋁材預埋盒 IP65

Forniluce

Magnetic track light series

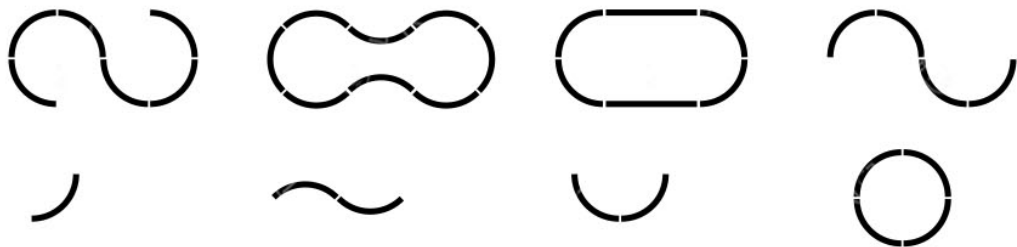



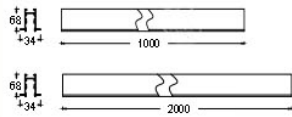

A5102-1 1M

A5102-2 2M

材質: 鋁
 顏色: 黑色
 備註: 軌道用於 明裝 / 吊裝 / 暗裝 / 可選尺寸 1M / 2M

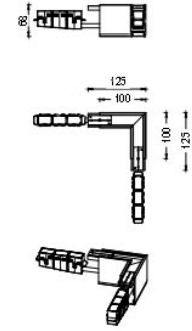

A5102-7

材質: 鋁
 顏色: 黑色
 備註: 平面直接轉角器 用於 明裝 / 吊裝 / 暗裝

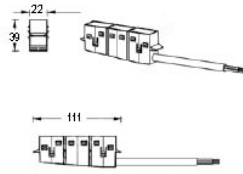

A5102-3

材質: 塑料
 顏色: 黑色
 備註: 用於開關電源與軌道間的導電連接

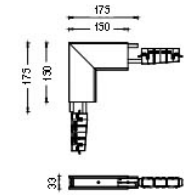

A5102-8

材質: 鋁
 顏色: 黑色
 備註: 立面直接轉角器 用於 明裝 / 吊裝 / 暗裝

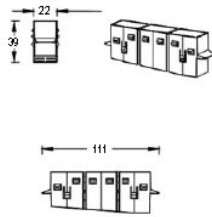

A5102-4

材質: 鋁 + 塑料
 顏色: 黑色
 備註: 用於兩支軌道之間連接和通電

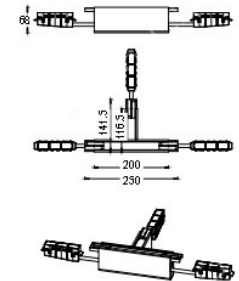

A5102-9

材質: 鋁
 顏色: 黑色
 備註: T字轉角器 用於 明裝 / 吊裝 / 暗裝

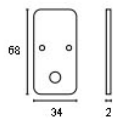

A5102-5

材質: 鋁
 顏色: 黑色
 備註: 堵頭



A5102-6

尺寸: L1500mm
 材質: 鋁
 顏色: 黑色
 備註: 吊線包

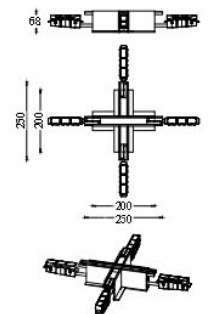

A5102-9A

材質: 鋁
 顏色: 黑色
 備註: 十字轉角器 用於 明裝 / 吊裝 / 暗裝



A5103-1

燈珠功率: 10W
 顯指: ≥ 90
 光源品牌: PHILIPS
 色溫: A-3000K B-4000K

電材保

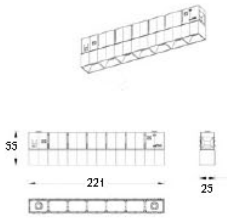

壓: DC48V
 質: 可彎曲軟硅膠
 固: 3年



A5103-5

燈珠功率: 10W
 顯指: ≥ 90
 光源品牌: 普瑞
 色溫: A-3000K B-4000K

光束角: $15^{\circ}\sim 36^{\circ}$
 電壓: DC48V
 材質: 鋁 + 軟硅膠
 保固: 3年

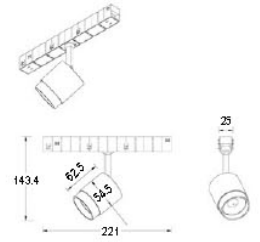

壓: DC48V
 質: 可彎曲軟硅膠
 固: 3年



A5103-2

燈珠功率: 10W
 顯指: ≥ 90
 光源品牌: PHILIPS
 色溫: A-3000K B-4000K

電材保

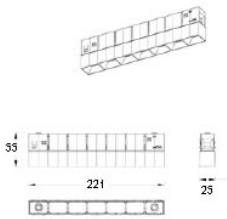

壓: DC48V
 質: 可彎曲軟硅膠
 固: 3年



A5103-6 1500mm 1/4

尺寸: 34 x 68mm

A5103-7 1200mm 1/4

尺寸: 34 x 68mm

A5103-8 900mm 1/4

尺寸: 34 x 68mm

材質: 鋁
 顏色: 黑色
 備註: 1/4 圓弧軌道用於明裝 / 吊裝 / 暗裝
 可選尺寸 $\varnothing 900$ $\varnothing 1200$ $\varnothing 1500$ mm 可訂製長度

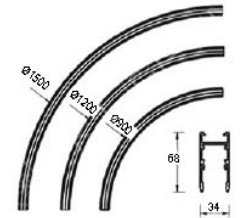

A5103-3

燈珠功率: 10W
 顯指: ≥ 90
 光源品牌: PHILIPS
 色溫: A-3000K B-4000K

電材保

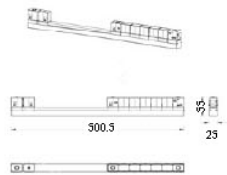

壓: DC48V
 質: 可彎曲軟硅膠
 固: 3年



A5103-9A 900mm

尺寸: 900 x 68mm

A5103-9B 1200mm

尺寸: 1200 x 68mm

A5103-9C 1500mm

尺寸: 1500 x 68mm

材質: 鋁
 顏色: 黑色
 備註: 圓弧軌道用於明裝 / 吊裝 / 暗裝
 尺寸 $\varnothing 900$ $\varnothing 1200$ $\varnothing 1500$ mm 可訂製長度

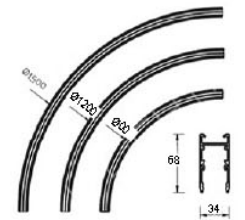

A5103-4

燈珠功率: 20W
 顯指: ≥ 90
 光源品牌: PHILIPS
 色溫: A-3000K B-4000K

電材保

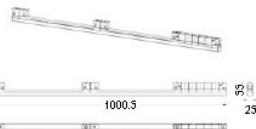

壓: DC48V
 質: 可彎曲軟硅膠
 固: 3年

燈具使用卡扣固定
 燈具柔性可以隨時移動
 可以實現靈活性和適用性再各種環境需求

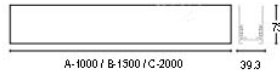

A5104-1A L-1000

A5104-1B L-1500

A5104-1C L-2000

材質: 鋁
顏色: 黑色
備註: 用於 明裝 / 吊裝 / 暗裝 磁吸軌道



A5104-6

產品說明: 軌道吊線
材質: 鋁
備註: 適用於吊裝

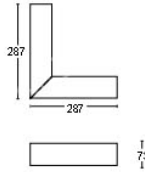
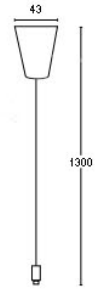

A5104-2

材質: 鋁
顏色: 黑色
備註: 平面直角轉彎器

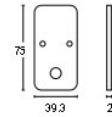

A5104-7

產品說明: 軌道尾蓋
材質: 鋁
備註: 適用於軌道結束位置

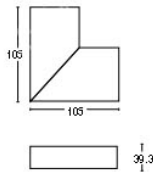

A5104-3

材質: 鋁
顏色: 黑色
備註: 立面直角轉彎器

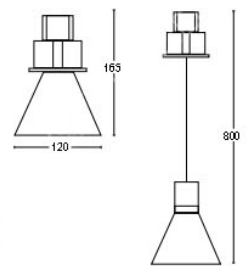

A5104-8A

A5104-8B

功 率 : 5W
顯 指 : ≥ 90
光源品牌: PHILIPS
色 溫 : A-3000K B-4000K

電 壓 : DC24V
材 質 : 鋁 + 清光玻璃
保 固 : 3年

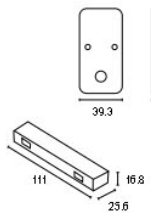

A5104-4

材質: 鋁
產品說明: 電源頭
備註: 適用軌道導電輸入

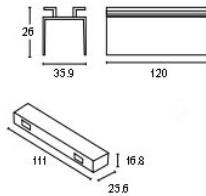

A5104-5

材質: 鋁
產品說明: 中間通電器
備註: 適用兩條軌道連接和導電

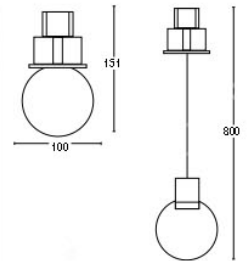

A5104-9A

A5104-9B

功 率 : 5W
顯 指 : ≥ 90
光源品牌: PHILIPS
色 溫 : A-3000K B-4000K

電 壓 : DC24V
材 質 : 鋁 + 清光玻璃
保 固 : 3年

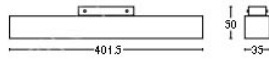

A5105-1

功 率：22W
 顯 指：≥ 90
 光源品牌：PHILIPS
 色 溫：A-3000K B-4000K

電 壓：DC24V
 電 材 質：鋁
 保 固：3年

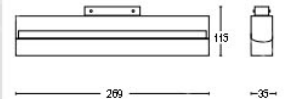

A5105-5

功 率：15W
 顯 指：≥ 90
 光源品牌：PHILIPS
 色 溫：A-3000K B-4000K

電 壓：DC24V
 電 材 質：鋁
 保 固：3年

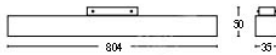

A5105-2

功 率：45W
 顯 指：≥ 90
 光源品牌：PHILIPS
 色 溫：A-3000K B-4000K

電 壓：DC24V
 電 材 質：鋁
 保 固：3年

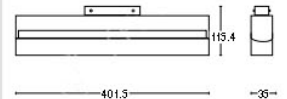

A5105-6

功 率：22W
 顯 指：≥ 90
 光源品牌：PHILIPS
 色 溫：A-3000K B-4000K

電 壓：DC24V
 電 材 質：鋁
 保 固：3年



A5105-3

功 率：15W
 顯 指：≥ 90
 光源品牌：PHILIPS
 色 溫：A-3000K B-4000K

電 壓：DC24V
 電 材 質：鋁
 保 固：3年

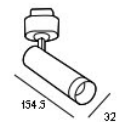

A5105-7A

功 率：5W
 顯 指：≥ 90
 光源品牌：PHILIPS
 色 溫：A-3000K B-4000K

電 壓：DC24V
 電 材 質：鋁
 保 固：3年

A5105-7B

A5105-7C

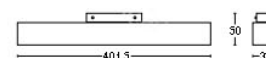

A5105-4

功 率：22W
 顯 指：≥ 90
 光源品牌：PHILIPS
 色 溫：A-3000K B-4000K

電 壓：DC24V
 電 材 質：鋁
 保 固：3年

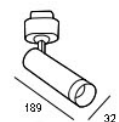

A5105-8A

功 率：10W
 顯 指：≥ 90
 光源品牌：PHILIPS
 色 溫：A-3000K B-4000K

電 壓：DC24V
 電 材 質：鋁
 保 固：3年

A5105-8B

A5105-8C

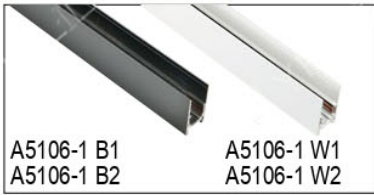
 A5106-1 B1
A5106-1 B2
A5106-1 W1
A5106-1 W2

編號	尺寸	產品說明	材質
A5106-1 W1	L1000 W27 H55mm		鋁
A5106-1 W2	L2000 W27 H55mm	明裝 / 吊裝 / 暗裝軌道	鋁
A5106-1 B1	L1000 W27 H55mm	附前後蓋	鋁
A5106-1 B2	L2000 W27 H55mm	兩米軌道運費另計	鋁

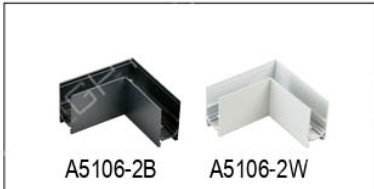
 A5106-2B
A5106-2W

產品說明
軌道平面 L 接頭
尺寸：90 x 90 x 55mm
材質：鋁

 A5106-3B
A5106-3W

產品說明
軌道立面 L 接頭
尺寸：90 x 90 x 55mm
材質：鋁

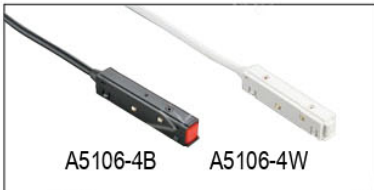
 A5106-4B
A5106-4W

尺寸	產品說明
L370mm	磁吸軌道電源頭

 A5106-5B
A5106-5W

尺寸	產品說明
L200mm	磁吸軌道一字電源接頭

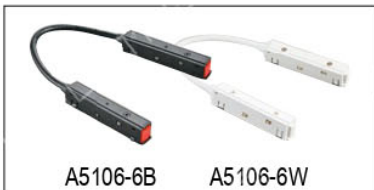
 A5106-6B
A5106-6W

尺寸	產品說明
L375mm	磁吸軌道轉角接頭

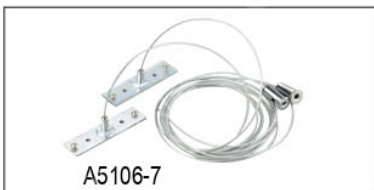

A5106-7

產品說明
軌道明裝鋼絲吊線 線長 1900mm 可調



A5106-8

尺寸	功率	顯指	光源品牌	色溫	電壓	材質	保固
W65 H65 D45mm	12W	≥ 90	OSRAM	A-3000K B-4000K	DC48V	鋁 附安全扣	2 年



A5106-9

尺寸	功率	顯指	光源品牌	色溫	電壓	材質	保固
W50 H300mm 線長 800mm 可調	10W	≥ 90	OSRAM	A-3000K B-4000K	DC48V	鋁 附安全扣	2 年



A5106-9A

尺寸	功率	顯指	光源品牌	色溫	電壓	材質	保固
W40 H300mm 線長 800mm 可調	7W	≥ 90	OSRAM	A-3000K B-4000K	DC48V	鋁 附安全扣	2 年

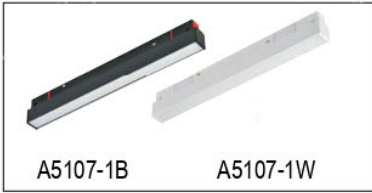

尺寸	功率	顯指	光源品牌	色溫	電壓	材質	保固
L220 W23 H45mm	12W	≥ 90	OSRAM	A-3000K B-4000K	DC48V	鋁 附安全扣	2年



尺寸	功率	顯指	光源品牌	色溫	電壓	材質	保固
L328 W23 H45mm	18W	≥ 90	OSRAM	A-3000K B-4000K	DC48V	鋁 附安全扣	2年



尺寸	功率	顯指	光源品牌	色溫	電壓	材質	保固
L220 W23 H45mm	12W	≥ 90	OSRAM	A-3000K B-4000K	DC48V	鋁 附安全扣	2年
							



尺寸	功率	顯指	光源品牌	色溫	電壓	材質	保固
L328 W23 H45mm	18W	≥ 90	OSRAM	A-3000K B-4000K	DC48V	鋁 附安全扣	2年
							



尺寸	功率	顯指	光源品牌	色溫	電壓	材質	保固
L112 W23 H13mm	6W	≥ 90	OSRAM	A-3000K B-4000K	DC48V	鋁 附安全扣	2年
							

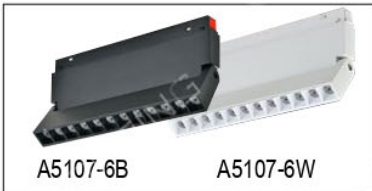

尺寸	功率	顯指	光源品牌	色溫	電壓	材質	保固
L220 W23 H13mm	12W	≥ 90	OSRAM	A-3000K B-4000K	DC48V	鋁 附安全扣	2年
							



尺寸	功率	顯指	光源品牌	色溫	電壓	材質	保固
Ø45 H100mm	10W	≥ 90	OSRAM	A-3000K B-4000K	DC48V	鋁 附安全扣	2年



尺寸	功率	顯指	光源品牌	色溫	電壓	材質	保固
Ø55 H120mm	15W	≥ 90	OSRAM	A-3000K B-4000K	DC48V	鋁 附安全扣	2年



尺寸	功率	顯指	光源品牌	色溫	電壓	材質	保固
Ø65 H130mm	24W	≥ 90	OSRAM	A-3000K B-4000K	DC48V	鋁 附安全扣	2年

Fornitace

Magnetic track light series

設定開關時間

亮度可調

安全低壓

手機遠端

自訂情景模式

分組管理

AI
智慧管理系統



Siri



Google Assistant



Google Home



SMART LIFE



tuya



A5108-1

產品說明	材質	顏色
------	----	----

智能網關 (無線)
(2.4G + mesh 網關)

可連接天貓精靈 / 小度 / 小愛
塗鴉智能 APP 2.4G+mesh
可連接 64 個節點

--



A5108-2

產品說明	材質	顏色
------	----	----

12 鍵智能觸摸無線開關

玻璃板隨意貼
總開關 + 四分組開關
亮度色溫 +-

白色



A5108-3

產品說明	材質	顏色
------	----	----

12 路 2.4G 遙控器
12 路 +4 情景
色溫切換功能

無線控制智能家居產品簡單對碼就能控制
無需安裝、無需網關控制的智能產品
數量不限，有效距離約 20 米
可以分 12 路 +4 情景

黑色



A5108-4

產品說明	Model No.	Output	Tol.	R&N	Effi.
------	-----------	--------	------	-----	-------

明緯驅動電源

LRS-75-48	24V .0~3.2A	±1%	150mV	90.0%
LRS-100-48	24V .0~4.5A	±1%	150mV	90.0%
LRS-150-48	24V .0~6.5A	±1%	200mV	89.0%
LRS-200-48	24V .0~8.8A	±1%	150mV	89.5%
LRS-350-48	24V .0~15.6A	±1%	150mV	88.0%

高階版磁吸軌道
 可用遙控器調光 調色 也可以智能手機控制
 可外接網路開關 配件需另購



A5109-1

尺寸	功率	顯指	光源品牌	色溫	電壓	材質	保固
Ø55 H120mm	15W	≥ 90	普瑞	2700~6000K 可調光 調色	DC48V	鋁 附安全扣	2年



A5109-2

尺寸	功率	顯指	光源品牌	色溫	電壓	材質	保固
L220 W23 H113mm	12W	≥ 90	普瑞	2700~6000K 可調光 調色	DC48V	鋁 附安全扣	2年
 防眩光蜂巢網							



A5109-3

尺寸	功率	顯指	光源品牌	色溫	電壓	材質	保固
L220 W23 H45mm	12W	≥ 90	普瑞	2700~6000K 可調光 調色	DC48V	鋁 附安全扣	2年
 防眩光蜂巢網							



A5109-4

尺寸	功率	顯指	光源品牌	色溫	電壓	材質	保固
L328 W23 H45mm	18W	≥ 90	普瑞	2700~6000K 可調光 調色	DC48V	鋁 附安全扣	2年
 防眩光蜂巢網							



A5109-5

尺寸	功率	顯指	光源品牌	色溫	電壓	材質	保固
L305 W23 H45mm	12W	≥ 90	普瑞	2700~6000K 可調光 調色	DC48V	鋁 附安全扣	2年



A5109-6

尺寸	功率	顯指	光源品牌	色溫	電壓	材質	保固
L605 W23 H45mm	24W	≥ 90	普瑞	2700~6000K 可調光 調色	DC48V	鋁 附安全扣	2年

YK LIGHTING



Fornilunce Outdoor lighting