

## | 智慧家居



05 智慧 i 系列

## | 商業



15 磁吸軌道燈



19 鋁槽燈



21 軟條燈



29 重點投射崁燈



43 基礎照明崁燈



60 軌道投射燈



75 筒燈

## | 居家



81 調光吸頂燈



92 室內 / 戶外吸頂燈



99 居家壁燈



107 檯燈



111 感應層板燈



112 小夜燈



113 殺菌燈

## | 辦公學校



115 平板燈



121 輕架燈



123 辦公室吊燈



137 支架燈



140 燈管型燈具

## | 戶外



149 天井燈



155 泛光燈



165 路燈



169 防潮燈



171 戶外高燈



174 草皮燈



183 太陽能系列



189 戶外壁燈



207 階梯地底燈



212 照樹燈

## | LED 光源類



216 工 / 商業用燈泡



219 居家燈泡



229 燈絲燈



231 燈管



237 AR111



239 MR16

## | 其他



241 感應器



243 緊急照明燈



244 LED 驅動器

245 光學資料





舞光 i 系列  
智慧照明 · 人性互動 · 想像未來

| 通訊平台 · 通訊協定 |



支援

Ok Google

台灣大哥大  
智慧家庭

米家APP



| 應用面 |



聲控



壁控



APP



調光



調色



情境

intelligent · interactive · imaginable

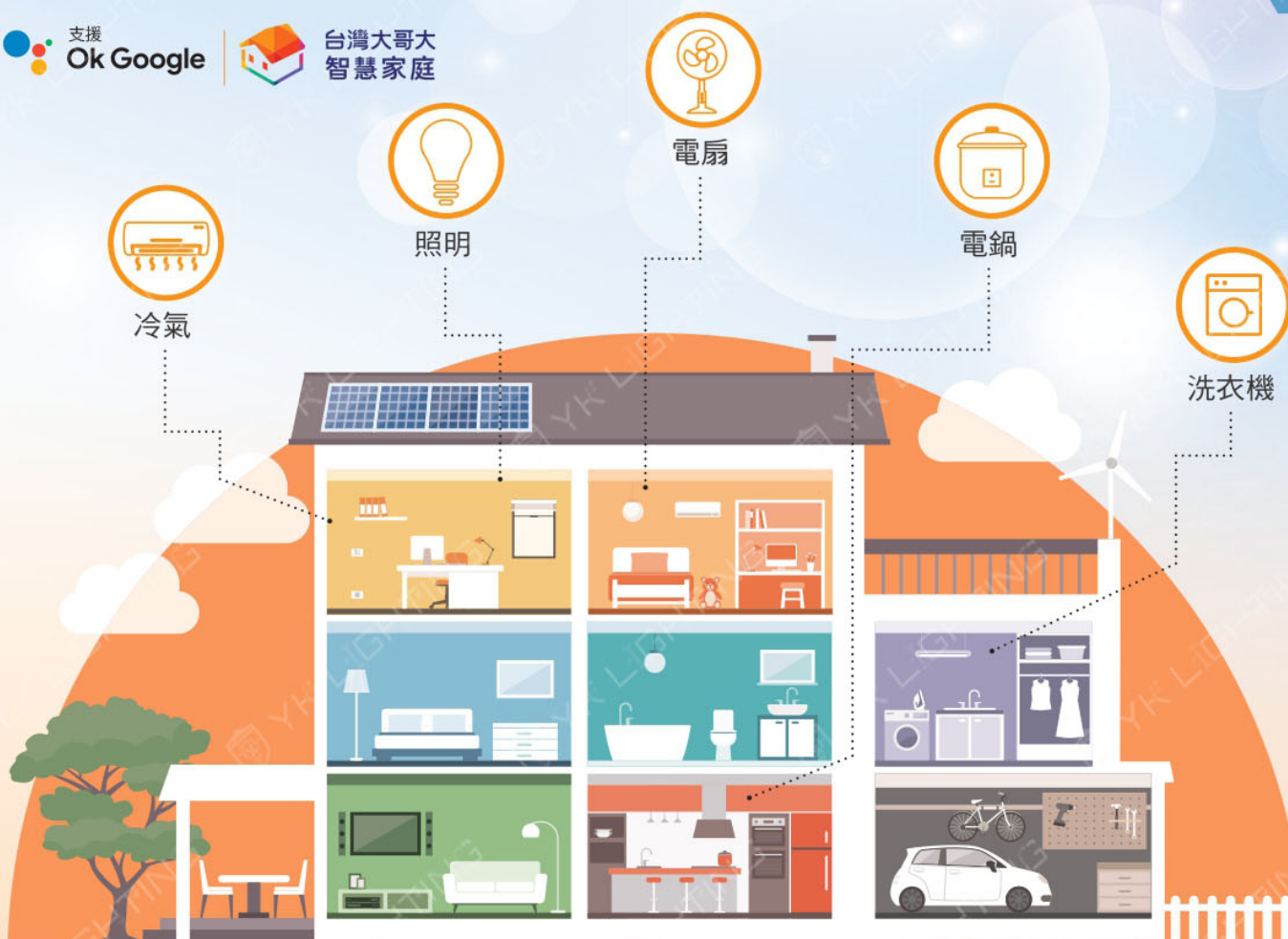

## Google 單一 APP 全面整合 只要一款 APP 輕鬆整合智慧家庭

### 覺得智慧家庭很難入手嗎？

舞光秉持 30 餘年對照明應用的深耕與堅持，以「家」為出發點，致力開發多元產品。因應智慧家庭的趨勢，推出「台灣大哥大」與「米家」雙平台智慧家庭系統。多樣家電品項皆可簡易串連、易於控制，搭配情境設置有更多的應用想像空間，讓生活更便利，輕鬆打造智慧家。

讓我們一起進入智慧家庭的美好未來。





### 輕鬆打造智慧家

成為您的專屬祕書  
生活中的大小事，全靠它輕鬆打點

支援  
**Ok Google**



台灣大哥大  
智慧家庭



Ok Google, 睡覺了

智慧燈泡  
關閉燈光

智慧風扇  
啟動定時關閉



智慧音箱  
播報天氣/行程

明天早晨氣溫 26°C · 上午 10 點有部門會議



### APP遙控，打造光氛圍

連動專屬APP，隨時切換生理光譜  
色溫與亮度簡單調整



黃光  
3000K  
溫馨放鬆

自然光  
4000K  
自然舒適

白光  
6500K  
明亮清晰



### 智慧排程，輕鬆做事沒煩惱

依照生活習慣，設定專屬排程  
時間一到即刻啟動

時間來到 19:30

預約完成!

智慧燈泡  
開啟日光模式

智慧風扇  
開啟微風模式

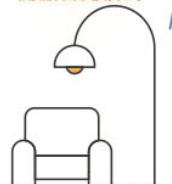

支援  
**Ok Google** APP 使用教學



聲控



壁控



APP



國家通訊傳播委員會



無藍光  
危害



< 2022 Q2 上市 >



### 舞光 50W Ai 智慧吸頂燈

45,000

產品型號	LED-CES50-TWM
消耗電力	50W
輸入電壓	100V-240V(全電壓)
色溫	3000K ~ 6500K(壁切調色:白光/黃光/小夜燈)
光通量	100 ~ 5000LM
演色性	≥ 90
燈體材質	鐵底盤、PMMA 擴散罩
適用APP	台灣大哥大智慧家庭、Google Home
Wi-Fi	Wi-Fi4 2.4GHz
安全性	WPA-PSK/WPA2-PSK 安全加密機制



< 2022 Q2 上市 >

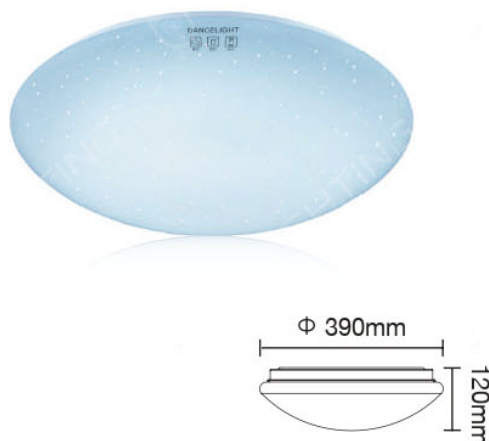

### 舞光 30W Ai 智慧吸頂燈

25,000

產品型號	LED-CES30-TWM
消耗電力	30W
輸入電壓	100V-240V(全電壓)
色溫	3000K ~ 6500K(壁切調色:白光/黃光/小夜燈)
光通量	100 ~ 2900LM
演色性	≥ 90
燈體材質	鐵底盤、PMMA 擴散罩
適用APP	台灣大哥大智慧家庭、Google Home
Wi-Fi	Wi-Fi4 2.4GHz
安全性	WPA-PSK/WPA2-PSK 安全加密機制





台灣大哥大  
智慧家庭



國家通訊傳播委員會

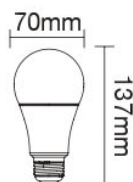

< 2022 Q2 上市 >

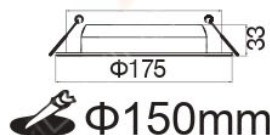

< 2022 Q2 上市 >

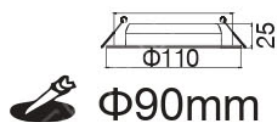

APP 使用教學



聲控



壁控



APP

## 舞光 12W Ai 智慧燈泡

5,500

產品型號	LED-E2712-TWM
消耗電力	3-12W
輸入電壓	100V-240V(全電壓)
色溫	3000K ~ 6500K(壁切調色: 白光 / 黃光 / 小夜燈)
光通量	100 ~ 1000LM
演色性	≥ 95
燈體材質	PBT、PC 罩、塑包鋁
適用APP	台灣大哥大智慧家庭、Google Home
適用坪數	3-6 顆 / 3-8 坪
Wi-Fi	Wi-Fi 4 2.4GHz
安全性	WPA-PSK/WPA2-PSK 安全加密機制

## 舞光 16W 15cm Ai 智慧崁燈

7,200

產品型號	LED-15DOP16-TWM
消耗電力	16W
輸入電壓	100V-240V(全電壓)
色溫	3000K ~ 6500K(壁切調色: 白光 / 黃光 / 小夜燈)
光通量	100 ~ 1400LM
演色性	≥ 90
燈體材質	散熱塑、PC 罩
適用APP	台灣大哥大智慧家庭、Google Home
發光角度	160°
Wi-Fi	Wi-Fi 4 2.4GHz
安全性	WPA-PSK/WPA2-PSK 安全加密機制

## 舞光 7W 9cm Ai 智慧崁燈

6,500

產品型號	LED-9DOP7-TWM
消耗電力	7W
輸入電壓	100V-240V(全電壓)
色溫	3000K ~ 6500K(壁切調色: 白光 / 黃光 / 小夜燈)
光通量	100 ~ 560LM
演色性	≥ 90
燈體材質	散熱塑、PC 罩
適用APP	台灣大哥大智慧家庭、Google Home
發光角度	36°
Wi-Fi	Wi-Fi 4 2.4GHz
安全性	WPA-PSK/WPA2-PSK 安全加密機制



支援

Ok Google

台灣大哥大  
智慧家庭

APP 使用教學



聲控



壁控



APP



國家通訊傳播委員會

無藍光  
危害

新品

舞光 Ai 智慧支架燈

&lt; 2022 Q2 上市 &gt;

※ 串接線另計

LED-T5BA-PCDR2

保護眼睛・還原真實色彩

舒適美肌光，完美色彩呈現  
無藍光危害認證，保護雙眼

舞光・LED

真實還原色彩，雙眼更舒適

他牌

光源演色性不足，物體黯然失色

1. APP 調光調色，多種情境好應用
2. RA90 高演色性，還原真實色彩
3. 語音、壁控、APP，多種控制方式
4. 可搭配定時與情境設定

1 尺 **5,000**2 尺 **6,000**4 尺 **7,000**

產品型號	LED-T5BA1-TWM	LED-T5BA2-TWM	LED-T5BA4-TWM
消耗電力	5W	9W	18W
尺寸	W:300mm D:26mm H:37mm	W:600mm D:26mm H:37mm	W:1182mm D:26mm H:37mm
色溫	3000K-6500K( 壁切調色：白光 / 黃光 / 小夜燈 )		
光通量	100 ~ 400LM	100 ~ 900LM	100 ~ 1600LM
演色性	≥ 90		
輸入電壓	100V-240V( 全電壓 )		
燈體材質	PC		
Wi-Fi	Wi-Fi4 2.4GHz		
安全性	WPA-PSK/WPA2-PSK 安全加密機制		
適用APP	台灣大哥大智慧家庭、Google Home		



台灣大哥大  
智慧家庭



**AIRMATE**



可聲控



智能感溫



搭配智慧音箱  
聲控操作



專利七片羽翼  
減震扇葉



14吋大扇葉  
大風量



32 檔風  
多類風種



定時預約  
遠端開關機



擺頭調整

下俯角 11.5°

上仰角 300°

左右擺頭 70°



LED 顯示

45 秒自動熄屏



ULTRON



## 奧創智慧插座 Lite

4,800

產品型號	UT-3702-B
電力額定功率	125VAC 15A 50/60HZ 1875W
Wi-Fi	Wi-Fi4(2.4GHz 802.11b/g/n)
安全性	WPA-PSK/WPA2-PSK 安全加密機制
適用APP	台灣大哥大智慧家庭、Google Home
尺寸	76 x 40 x 33mm

1. 家電的魔術師，無痛升級為智慧家電
2. 可定時排程、支援聲控
3. 隨插即用，過載安全保護機制
4. 適用於機械式開關之家電



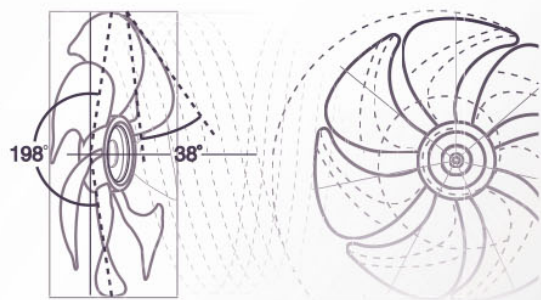

內附遙控器

可搭配  
溫濕度感應器

UT-U301-A

## 艾美特 DC 智慧節能遙控立扇

31,000

產品型號	FS35126RI
規 格	14 吋
材 質	ABS 原生塑料
消耗電力	28W
風速段數	32 段強弱調整
風類模式	智能感溫 / 自然 / 睡眠
定時功能	15 小時定時關機 / 預約開機
尺 寸	424 x 424 x 1353mm
操控方式	手控按鈕、遙控、APP、聲控 (需搭配智慧音箱)

1. 專利三重消音減震系統，穩固合金圈有效減弱震動
2. 仿生羽翼柔化氣流，增大葉面有效切風面積
3. 背部 198° 廣角型設計，更寬扇葉橫截面
4. 多角度切割，38° 扇尖平滑破風，細膩給風



ULTRON



## 奧創智慧溫濕度感應器

5,500

產品型號	UT-U301-A
電 源	Type C 5V/0.5A
W i - F i	Wi-Fi 及 BLE
安 全 性	WPA-PSK/WPA2-PSK 安全加密機制
檢測範圍	溫度 -20°C-60°C、濕度 20-90%RH
適用APP	台灣大哥大智慧家庭、Google Home
尺 寸	51.4 x 51.4 x 18.6mm

1. Smarter key: 產品無限數量一鍵即連
2. 遠端偵測家中溫濕度
3. 可連動其他智慧設備





米家 APP



吸塵器



照明



電扇



空氣清淨機



投影機

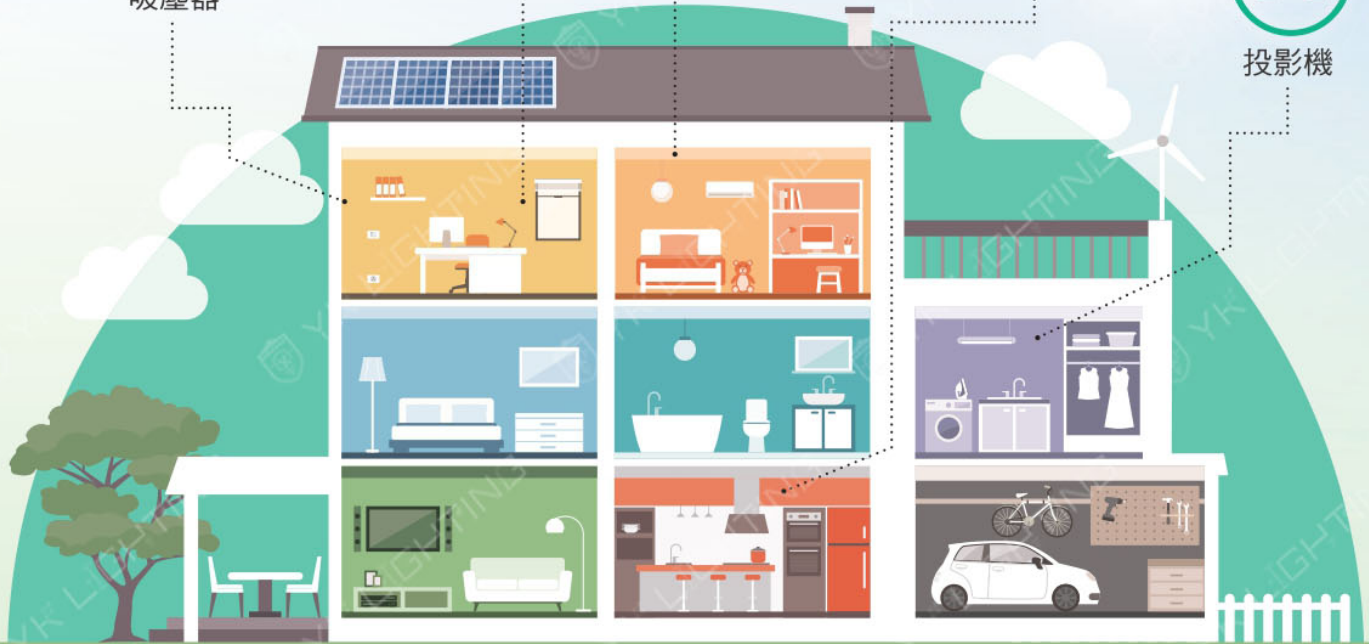

## 米家智慧家庭 APP 全面整合 只要一款 APP 輕鬆整合智慧家庭



舞光 i 專頁

晨光

清晨6點的自然光，給你起床的好精神

日午

中午12點的白光，讓你精神飽滿活力滿分

夕陽

傍晚6點的暖光，幫你卸下一天的疲憊

星空

晚上10點的夜幕，讓你放鬆睡好眠



聲控



APP



壁切

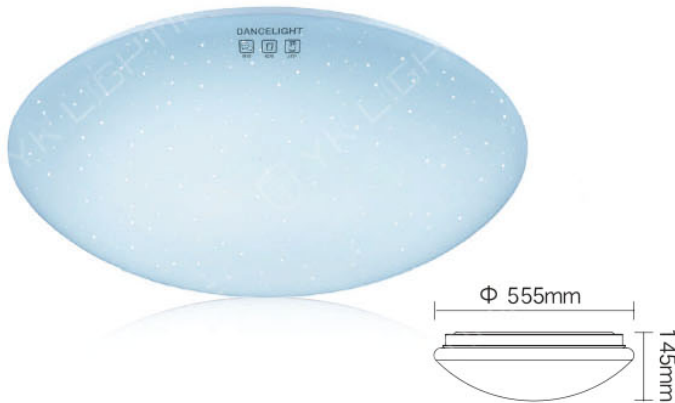

**舞光 50W 智能三用吸頂燈** 45,000

產品型號	LED-CES50-I
消耗電力	5W-50W
輸入電壓	100V-240V (全電壓)
色溫	3000K ~ 6500K (壁切調色: 白光、黃光、自然光、小夜燈)
光通量	100 ~ 5000LM
演色性	≥ 90
燈體材質	鐵底盤、PMMA 燈罩
適用APP	米家



**舞光 12W 智能三用球泡** 5,500

產品型號	LED-E2712-I
消耗電力	3W-12W
輸入電壓	100V-240V (全電壓)
色溫	3000K ~ 6500K (壁切調色: 白光、黃光、小夜燈)
光通量	100 ~ 1000LM
演色性	≥ 95
燈體材質	塑包鋁、PC 罩
適用APP	米家



**舞光 16W 智能三用嵌燈** 7,200

產品型號	LED-15DOP16-I
消耗電力	3W-16W
輸入電壓	100V-240V (全電壓)
色溫	3000K ~ 6500K (壁切調色: 白光、黃光、自然光、小夜燈)
光通量	100 ~ 1500LM
演色性	≥ 80
燈體材質	散熱塑、PC 罩
適用APP	米家

# 舞光商業空間

達文西磁吸投射軌道燈

< 2022 Q2 上市 >



1. 無主燈設計新趨勢
2. 款式多樣自由組合

3. RA90 超高演色性真實呈現被照物顏色
4. 防眩設計不刺眼



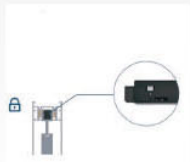

鎖附燈具好安心

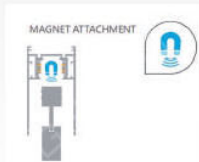

磁吸組裝便利性

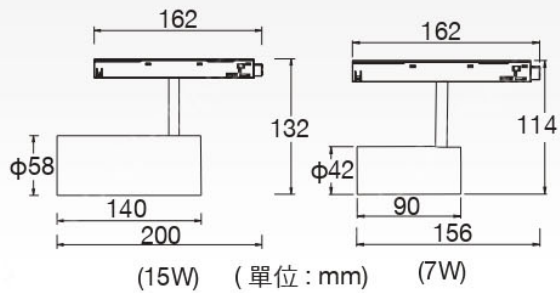

7/ 15W 投射光



達文西磁吸投射軌道燈

15W

7,000

7W

6,500

產品型號	消耗電力	色溫	光通量	演色性	輸入電壓	光束角	燈體材質
LED-MTTR15D	15W	5700K	1350LM	≥ 80	DC24V (需外接驅動器) 另計	36°	壓鑄鋁 PC PMMA 罩
LED-MTTR15N	15W	4000K	1200LM	≥ 90			
LED-MTTR15W	15W	3000K	1125LM	R9>50			
LED-MTTR7D	7W	5700K	560LM	≥ 80			
LED-MTTR7N	7W	4000K	490LM	≥ 90			
LED-MTTR7W	7W	3000K	420LM	R9>50			



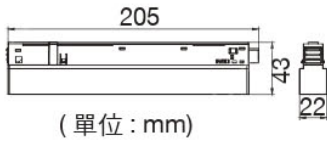

防眩設計



### 12W 達文西磁吸窄角排燈

8,000

產品型號	消耗電力	色溫	光通量	演色性	輸入電壓	光束角	燈體材質
LED-MTSPL12D	12W	5700K	1020LM	$\geq 80$	DC24V (需外接驅動器) 另計	30°	壓鑄鋁 PC
LED-MTSPL12N	12W	4000K	960LM	$\geq 90$			
LED-MTSPL12W	12W	3000K	900LM	R9>50			

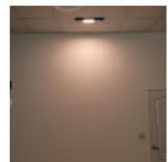
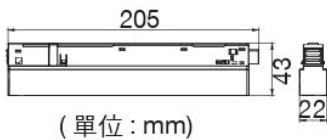

### 12W 達文西磁吸廣角排燈

8,000

產品型號	消耗電力	色溫	光通量	演色性	輸入電壓	發光角度	燈體材質
LED-MTFLL12D	12W	5700K	660LM	$\geq 80$	DC24V (需外接驅動器) 另計	110°	壓鑄鋁 PC
LED-MTFLL12N	12W	4000K	600LM	$\geq 90$			
LED-MTFLL12W	12W	3000K	600LM	R9>50			



防眩設計

[ 燈體可轉角 180° ]



12W 達文西磁吸可擺角排燈

11,000

產品型號	消耗電力	色溫	光通量	演色性	輸入電壓	光束角	燈體材質
LED-MTSPL12DRT	12W	5700K	1020LM	≥ 80	DC24V (需外接驅動器) 另計	30°	壓鑄鋁 PC
LED-MTSPL12NRT	12W	4000K	960LM	≥ 90			
LED-MTSPL12WRT	12W	3000K	900LM	R9>50			

嵌入式磁吸軌道 (1/2/3 米)

- LED-MT1-1 5,000
- LED-MT2-1 10,000
- LED-MT3-1 15,000

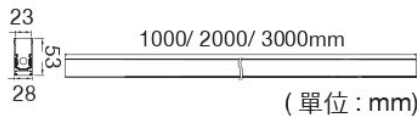

磁力吸附

嵌入式軌道

磁吸電源線

LED-MT-PCD 1,800

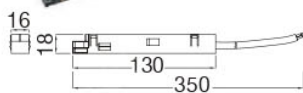

磁吸 I 字接頭

LED-MT-I 1,300



磁吸轉角接頭

LED-MT-IS 2,000

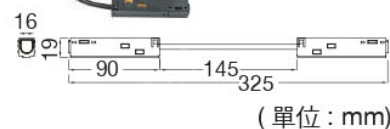

(單位: mm)



## 鋁槽燈與軟條燈系列



1. 燈具尺寸精巧、可搭配任何裝潢造型，  
輕鬆營造光影氛圍
2. 可搭配 COB、2835 軟條燈
3. 卡扣固定好安裝
4. 一體串接不斷光設計

※ 各款式牌價可參照下表

※ 可訂製尺寸並選擇出貨方式  
(整組含軟條燈、鋁槽空台)

牌價	品號	長度	驅動器	適用軟條燈	材質
7,000	LED-1220AT1D	1M	附明緯 15W 驅動器	2835 軟條燈 120P (白光 / 黃光 / 自然光)	鋁、PC 均光罩
12,500	LED-1220AT2D	2M	附明緯 20W 驅動器		
17,000	LED-1220AT3D	3M	附明緯 35W 驅動器		
4,500	LED-1220AT14D	1M	附舞光 8W 驅動器	2835 軟條燈 60P (白光 / 黃光 / 自然光)	
9,700	LED-1220AT24D	2M	附明緯 15W 驅動器		
12,000	LED-1220AT34D	3M	附明緯 15W 驅動器		



無暗區

不斷光

三種尺寸

可訂製

LED-1010AT

LED-1010ATWG < 2022 Q2 上市 >

LED-1212AT

LED-1220AT



嵌入式安裝

嵌入式無縫安裝

配件內附

LED-1010AT1-1

LED-1010ATWG1-1

頭尾塞 / 固定扣 / 螺絲

## 鋁槽燈

時價



新品

產品型號	尺寸圖	長度	適用軟條燈	燈體材質
LED-1010AT1-1		1 米	COB 軟條燈 2835 軟條燈 120P 另計	鋁、PC 均光罩
LED-1010AT2-1		2 米		
LED-1010AT3-1		3 米		
LED-1010ATWG1-1		1 米	COB 軟條燈 2835 軟條燈 120P 另計	
LED-1010ATWG2-1		2 米		
LED-1010ATWG3-1		3 米		
LED-1212AT1-1		1 米	COB 軟條燈 2835 軟條燈 240P 2835 軟條燈 120P 另計	
LED-1212AT2-1		2 米		
LED-1212AT3-1		3 米		
LED-1220AT1-1		1 米	COB 軟條燈 2835 軟條燈 240P 2835 軟條燈 120P 2835 軟條燈 60P 另計	
LED-1220AT2-1		2 米		
LED-1220AT3-1		3 米		



新品



新品



## 低壓室內 COB 軟條燈

< 2022 Q2 上市 >



室內  
專用

DC  
24V

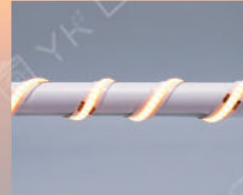

燈體柔韌好造型



不斷光設計

1. 完美超薄，無光斑，可彎（勿呈直角）
2. 超高演色性 RA90，博物館照明光品質
3. 適用櫥櫃、天花板、夾板等需光帶地方
4. 內附固定夾，依施工需要加強固定，可避免脫落
5. 每捆 5 米，最多可串接 10 米，每 4 公分可裁剪



附配件  
轉角連接線 / 連接器 / 固定片



DC24V  
驅動器  
另計

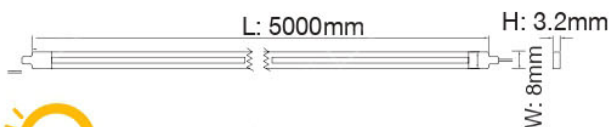

8,000

產品型號	消耗電力	色溫	光通量	裁切長度	晶片	輸入電壓	發光角度	燈體材質
LED-35CO24V10D	10W/ 米	白光	800LM/ 米	4cm	2835 晶片 384PCS/ 米	DC24V (需外接驅動器) 另計	120°	銅軟板 + 3M 背貼
LED-35CO24V10N	10W/ 米	自然光						
LED-35CO24V10W	10W/ 米	黃光						

低壓室內 LED 軟條燈

室內  
專用

DC  
12V

DC  
24V

1 DC12V 2835 60P 3,600

2 DC12V 5050 60P 6,000

3 DC12V 5050 彩色 9,000

新品 4 DC12V 2835 120P 6,500

新品 < 2022 Q2 上市 > 5 DC24V 2835 240P 12,500

- 完美超薄，可彎（勿呈直角），適用櫥櫃、天花板、夾板等需光帶地方
- 內附固定夾，依施工需要加強固定，可避免脫落
- 每捆 5 米，最多可串接 10 米，每 2.5 公分 / 5 公分可裁剪（參考下方表格）
- 彩色軟條燈，色彩變化需外接彩色控制器（另購）



配件內附 1,000

轉角連接線 / 連接器 / 固定片



驅動器

另計

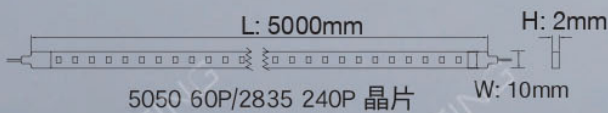

產品型號	消耗電力	色溫	光通量	裁切長度	晶片	輸入電壓	發光角度	燈體材質
1	LED-35NA12V-DR2	4W/ 米	白光	350LM/ 米	5cm	2835 晶片 60PCS/ 米	DC12V (需外接驅動器) 另計	120°  銅軟板 + 3M 背貼
	LED-35NA12V-NR2	4W/ 米	自然光					
	LED-35NA12V-WR2	4W/ 米	黃光					
	LED-35NA12V-BR2	4W/ 米	藍光					
2	LED-50NA12V-D	8W/ 米	白光	700LM/ 米	5cm	5050 晶片 60PCS/ 米	DC12V (需外接驅動器) 另計	120°  銅軟板 + 3M 背貼
	LED-50NA12V-N	8W/ 米	自然光					
	LED-50NA12V-W	8W/ 米	黃光					
	LED-50NA12V-B	8W/ 米	藍光					
3	LED-50NA12V-RGB	8W/ 米	彩色					
4	LED-35NA12V8D	8W/ 米	白光	800LM/ 米	2.5cm	2835 晶片 120PCS/ 米	DC12V (需外接驅動器) 另計	120°  銅軟板 + 3M 背貼
	LED-35NA12V8N	8W/ 米	自然光					
	LED-35NA12V8W	8W/ 米	黃光					
5	LED-35NA24V16D	16W/ 米	白光	1600LM/ 米	2.5cm	2835 晶片 240PCS/ 米	DC24V (需外接驅動器) 另計	120°  銅軟板 + 3M 背貼
	LED-35NA24V16N	16W/ 米	自然光					
	LED-35NA24V16W	16W/ 米	黃光					



低壓戶外霓虹燈帶  
< 2022 Q2 上市 >

IP66

抗  
UVDC  
24V

側發光

LED-35NT24V8DSI

正發光

LED-35NT24V8DFT

## 側發光 (SI)

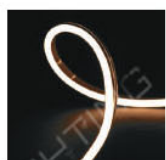

適用牆壁  
勾勒造型

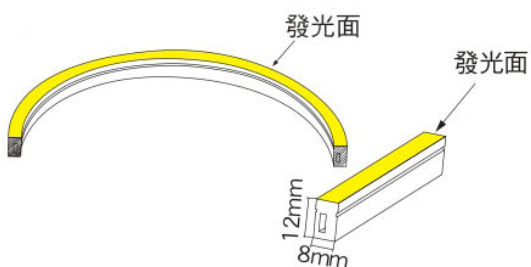

## 正發光 (FT)



適用天花板  
輔助照明

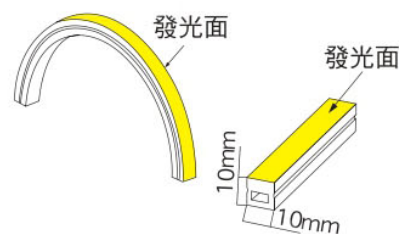

1. 靈活好運用，可做立面彎曲造型，無光斑
2. 適用櫥櫃、天花板、夾板等需光帶地方
3. 可使用於戶外，良好的耐候性及抗紫外線
4. 另有固定條可搭配，依施工需要加強固定，可避免脫落
5. 每捆 5 米，最多可串接 10 米，每 5.5 公分可裁剪



新品



驅動器

另計

14,000

產品型號	發光角度	消耗電力	色溫	光通量	裁切長度	輸入電壓	燈體材質
LED-35NT24V8DSI	110° (側發光)	8W/ 米	白光	420LM/ 米	5.5cm	DC24V (需外接驅動器) 另計	銅軟板 + 矽膠
LED-35NT24V8NSI		8W/ 米	自然光				
LED-35NT24V8WSI		8W/ 米	黃光				
LED-35NT24V8DFT	130° (正發光)	8W/ 米	白光	800LM/ 米			
LED-35NT24V8NFT		8W/ 米	自然光				
LED-35NT24V8WFT		8W/ 米	黃光				



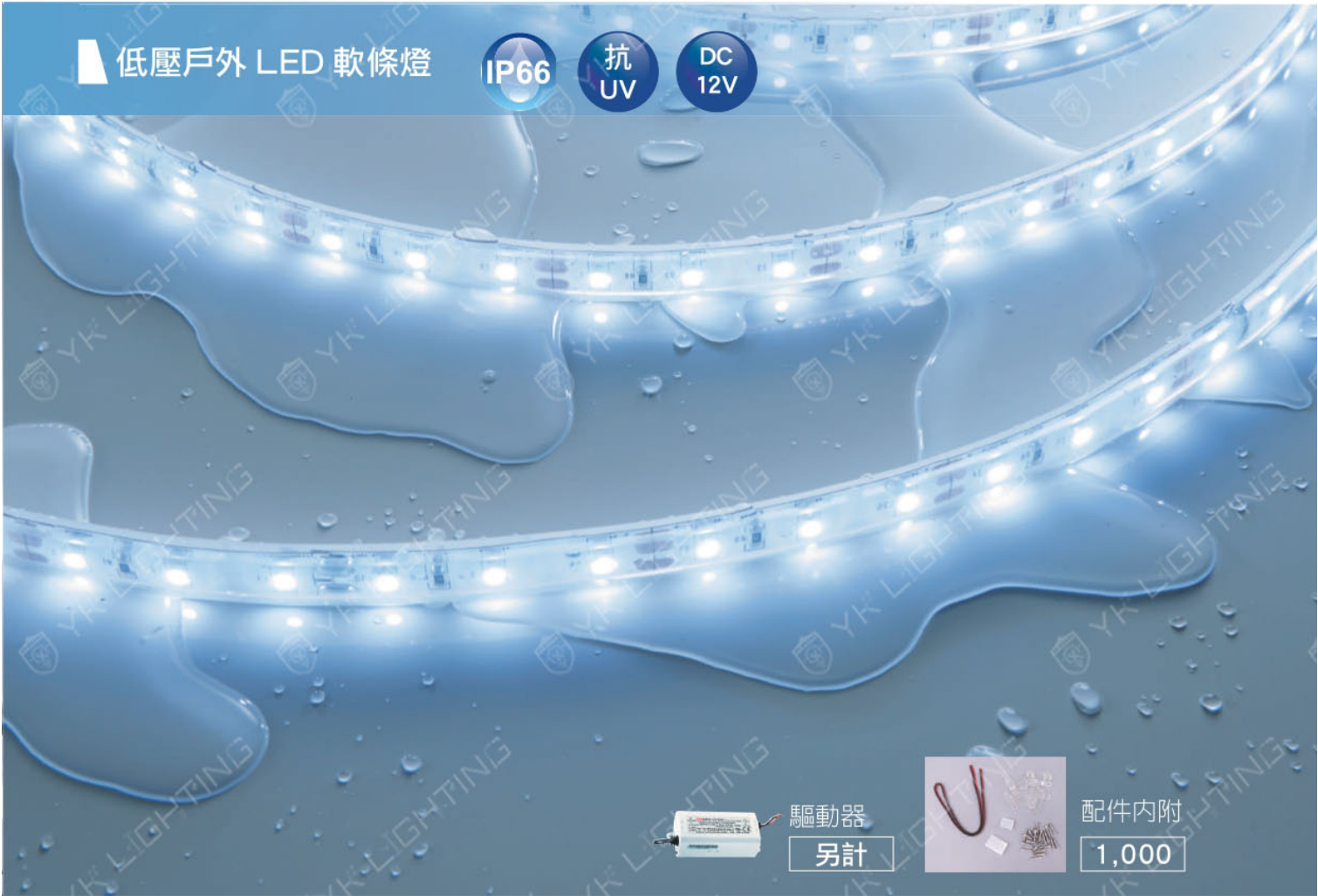

- 矽利康 (Silicone) 材質，戶外專用耐曬不易變黃
- 單一驅動器，最多可串接 10 米，  
每 5 公分可裁剪
- 每捆 5 米
- 內附固定夾，依施工需要加強固定，可避免脫落
- 請注意：與驅動器接線處，需請專業施工人員使用防水膠（如矽利康）包覆、做好防水施工

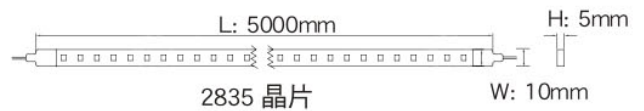

5050 軟條燈 **9,000**

2835 軟條燈 **7,500**

產品型號	消耗電力	色溫	光通量	裁切長度	晶片	輸入電壓	發光角度	燈體材質
LED-50WO12V-DR3	8W/ 米	白光	700LM/ 米	5cm	5050 晶片 60PCS / 米	DC12V (外接防水 驅動器另計)	120°	防水耐高溫 60°C 以下 透明矽利康 含 3M 背貼 固定夾
LED-50WO12V-WR3	8W/ 米	黃光						
LED-35WO12V-DR3	4W/ 米	白光	350LM/ 米		2835 晶片 60PCS / 米			
LED-35WO12V-WR3	4W/ 米	黃光						
LED-35WO12V-BR3	4W/ 米	藍						
LED-35WO12V-RR3	4W/ 米	紅						



1. PVC 戶外專用抗 UV 耐高溫材質
2. 防水公母接頭可直接串接
3. 內附固定夾，依施工需要加強固定，可避免脫落
4. 每捆 5 米
5. 單一電源線最多串接 45 米。  
110V 每 50 公分，220V 每 100 公分可裁剪，  
剪裁段需接電源線
6. 請注意：與電源線接線處，須請專業施工人員  
使用防水膠 (如矽利康包覆)，做好防水施工。

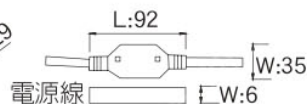
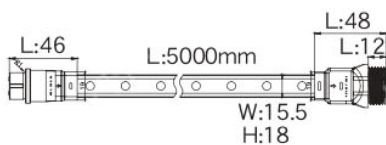

LED-50HVWO-ACC  
常壓電源線配件包內附

1,000

13,000

產品型號	消耗電力	色溫	光通量	裁切長度	晶片	輸入電壓	發光角度	燈體材質
LED-50HVWO/1-D	8W/ 米	白光	600LM/ 米	50cm	5050 晶片 60PCS/ 米 (每捆 5 米)	110V	120°	戶外專用 PVC 耐溫 60° C 以下
LED-50HVWO/1-W	8W/ 米	黃光	550LM/ 米			110V		
LED-50HVWO/2-W	8W/ 米	黃光	550LM/ 米	100cm		220V		



## 常壓雙排室內軟條燈 - 110V

室內  
專用

常壓



1. LED-35HV/1-DW 雙排超高亮度，可當一般照明使用
2. 110V 為每 50 公分可裁剪
3. 2835 可串接 50 米
4. 每捆 15 米
5. 剪裁後每段皆須加電源線

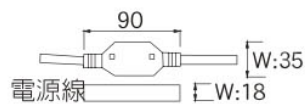
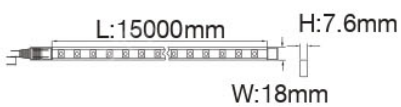

LED-35HV-ACCD  
雙排常壓電源線配件包內附

1,000

23,000

產品型號	消耗電力	色溫	光通量	裁切長度	晶片	輸入電壓	發光角度	燈體材質
LED-35HV/1-DW	13W/ 米	黃光	900LM/ 米	50cm	2835 晶片 180PCS/ 米 (每捆 15 米)	110V	120°	PVC (勿裝戶外)



## 彩色軟條燈 裁切及串接

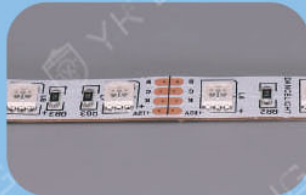

1 低壓彩色軟條燈每 5 公分一個裁切處



2 使用焊錫將兩端銅箔焊接起來



3 撕下背膠的保護膜，將軟條燈貼在安裝處



4 控制器和軟條燈串接，箭頭處接箭頭處（紅圈處）



5 驅動器的正極（紅線）接控制器的正極（棕線）  
驅動器的負極（黑線）接控制器的負極（藍線）—完工

## 兩條以上彩色軟條燈串接



1 驅動器的正極（紅線）接控制器的正極（棕線）  
驅動器的負極（黑線）接控制器的負極（藍線）



2 控制器和軟條燈串接，箭頭處接箭頭處（紅圈處）



3 第一條軟條燈尾端 +12V 處接串接線的黑色線。建議銅箔處使用焊錫焊上串接線以免接觸不良。



4 放大器 INPUT：剪下串接線上的快速接頭，將電線依照放大器 INPUT 處的標示連接，V+ 接黑色線，R 接紅色線，G 接綠色線，B 接藍色線。



5 放大器 OUTPUT：剪下串接線上的快速接頭，將電線依照放大器 OUTPUT 處的標示連接，V+ 接黑色線，R 接紅色線，G 接綠色線，B 接藍色線，POWER+ 與 - 接上電線，分別為放大器的正負極。



6 驅動器的正極（紅線）和放大器的正極連接  
驅動器的負極（黑線）和放大器的負極連接

## 戶外 低壓

### 需驅動器軟條燈

低壓 DC12V 軟條燈  
軟條燈裁切及串接安裝方式

#### ◆ 注意事項

- 1 低壓軟條燈需外接驅動器
- 2 低壓軟條燈分室內 / 戶外專用，請確認安裝地點後選購
- 3 安裝前請測試顏色及亮度，一經裁剪，良品無法退回



1

低壓軟條燈每 5 公分一個裁切處。  
裁切處有剪刀標示。



2

裁切處用小刀剝去塑料，  
露出焊接接線點。



3

電線套上前塞後，用焊槍將紅線 (+) 和黑線 (-)  
焊接在軟條燈上。



4

前塞須使用矽利康包覆，  
以防滲水。



5

套上後塞後，使用矽利康  
康包覆，以防滲水



6

將固定片置於軟條燈  
上，並用螺絲上鎖加以  
固定



7

軟條燈正負極線與驅動  
器正負極相接後啟動



8 串接方式

將兩端使用錫錫焊接後，  
使用矽利康將之全部封  
住，並重複 2-7 步驟。驅  
動器最多串接 10 公尺。

## 常壓

### 免驅動器軟條燈

高壓 110V/220V 軟條燈  
軟條燈裁切及串接電源接法

#### ◆ 注意事項

- 1 常壓免驅動器軟條燈一經裁剪需每段加裝電源線否則會燒毀
- 2 安裝前請測試顏色及亮度，一經裁剪，良品無法退回
- 3 測試請將軟條燈整捆拆開測試以防燒毀



1

220V 每 100 公分一個裁  
切處、110V 每 50 公分  
一個裁切處。



2

使用尾塞塞住尾端裁  
切處，再用矽利康包  
覆以防漏電及滲水。



3

插針尖處插在軟條燈  
上，並接觸到軟條燈內  
的銅線  
※注意插針有上下之分



4

在將電源線與軟條燈的  
插針接上  
※注意插針有上下之分



5

將固定片置於軟條燈  
上，並用螺絲上鎖加  
以固定

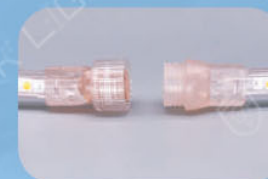

6

串接方法  
將欲串接的軟調燈拆除電  
源線，頭尾相接擰緊即可  
※高壓軟條燈最多可串接  
45 米



## 45W 挑高防眩崁燈



1. 飛利浦 DLM 燈板高亮度無色差
2. 驅動器無頻閃
3. 完美光型不眩光

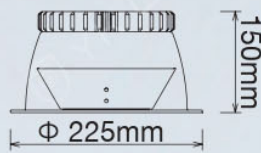

Φ205mm



驅動器

採用飛利浦 DLM 模組無色差

## 20.5 公分崁孔

23,000

產品型號	消耗電力	色溫	光通量	演色性	輸入電壓	發光角度	燈體材質
LED-25122NR1	45W	4000K	4250LM	≥ 80	100-240V (全電壓)	100°	壓鑄鋁
LED-25122WR1	45W	3000K	4250LM				



## 30W 挑高防眩崁燈

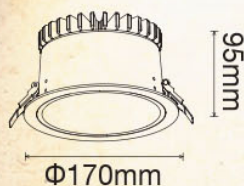

Φ150mm



採用飛利浦 DLM 模組無色差

驅動器

## 15 公分崁孔

18,000

產品型號	消耗電力	色溫	光通量	演色性	輸入電壓	發光角度	燈體材質
LED-25123NR1	30W	4000K	3000LM	≥ 80	100-240V (全電壓)	100°	壓鑄鋁
LED-25123WR1	30W	3000K					

## 30W/45W 黑鑽石炭燈



1. 飛利浦 COB 晶片均光且無色偏差
2. 超高演性真實呈現被照物顏色
3.  $R9 \geq 50$ ，對暖色系物品更加鮮艷
4. 採用無頻閃飛利浦驅動器



Φ245mm



採用飛利浦 COB 模組

## 24.5 公分炭孔 45W

18,000

產品型號	消耗電力	色溫	光通量	演色性	輸入電壓	光束角	燈體材質
LED-24DOD45DR1	45W	5000K	4300LM	$\geq 80, R9 > 0$	100-240V (全電壓)	90°	壓鑄鋁 玻璃
LED-24DOD45NR1	45W	4000K	3700LM	$\geq 90, R9 > 50$			
LED-24DOD45WR1	45W	3000K	3700LM	$\geq 90, R9 > 50$			

## 24.5 公分炭孔 30W

16,500

產品型號	消耗電力	色溫	光通量	演色性	輸入電壓	光束角	燈體材質
LED-24DOD30DR1	30W	5000K	2700LM	$\geq 80$	100-240V (全電壓)	90°	壓鑄鋁 玻璃
LED-24DOD30NR1	30W	4000K	2350LM	$\geq 90, R9 > 50$			
LED-24DOD30WR1	30W	3000K	2350LM	$\geq 90, R9 > 50$			



## 30W/45W 黑鑽石崁燈

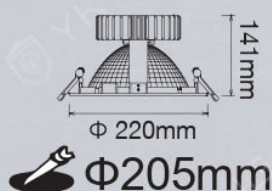

採用飛利浦 COB 模組

## 20.5 公分崁孔 45W

16,000

產品型號	消耗電力	色溫	光通量	演色性	輸入電壓	光束角	燈體材質
LED-21DOD45DR1	45W	5000K	4300LM	$\geq 80$	100-240V (全電壓)	50°	壓鑄鋁 玻璃
LED-21DOD45NR1	45W	4000K	3700LM	$\geq 90, R9>50$			
LED-21DOD45WR1	45W	3000K	3700LM	$\geq 90, R9>50$			

## 20.5 公分崁孔 30W

14,500

產品型號	消耗電力	色溫	光通量	演色性	輸入電壓	光束角	燈體材質
LED-21DOD30DR1	30W	5000K	2700LM	$\geq 80$	100-240V (全電壓)	50°	壓鑄鋁 玻璃
LED-21DOD30NR1	30W	4000K	2350LM	$\geq 90, R9>50$			
LED-21DOD30WR1	30W	3000K	2350LM	$\geq 90, R9>50$			



## 30W 挑高伸縮黑鑽石炭燈



RA90



1. 飛利浦 COB 晶片均光且無色偏差
2. 超高演性真實呈現被照物顏色
3.  $R9 \geq 50$ ，對暖色系物品更加鮮艷
4. 採用無頻閃飛利浦驅動器



往下可拉 50 度



水平可轉 350 度



採用飛利浦 COB 模組無色差

## 15.5 公分炭孔

16,000

產品型號	消耗電力	色溫	光通量	演色性	輸入電壓	光束角	燈體材質
LED-25124DR1	30W	5000K	2600LM	$\geq 80$	100-240V (全電壓)	45°	壓鑄鋁 玻璃
LED-25124NR1	30W	4000K	2200LM	$\geq 90, R9 > 50$			
LED-25124WR1	30W	3000K	2200LM	$\geq 90, R9 > 50$			

24W 黑鑽石崁燈

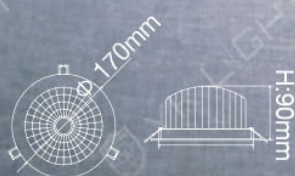

明緯驅動器 / CREE 晶片

## 15.5 公分崁孔

12,000

產品型號	消耗電力	色溫	光通量	演色性	輸入電壓	光束角	燈體材質
LED-15"DOD24D	24W	6500K	1350LM	≥ 80	100-240V (全電壓)	45°	壓鑄鋁 玻璃
LED-15"DOD24N	24W	4000K	1100LM	≥ 90, R9>50			
LED-15"DOD24W	24W	3000K	1100LM	≥ 90, R9>50			



## 12W 可轉角黑鑽石炭燈



[燈體可轉角 35°]



1. CREE COB 晶片均光且無色偏差
2. 超高演性真實呈現被照物顏色
3.  $R9 \geq 50$ ，對暖色系物品更加鮮艷
4. 採用無頻閃明緯驅動器

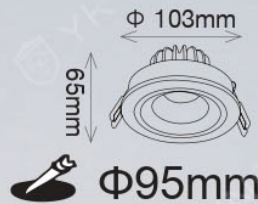

明緯驅動器 / CREE 晶片

## 9.5 公分炭孔

7,500

產品型號	消耗電力	色溫	光通量	演色性	輸入電壓	光束角	燈體材質
LED-25132DR1	12W	6000K	900LM	$\geq 80$	100-240V (全電壓)	35°	壓鑄鋁 玻璃
LED-25132NR1	12W	4000K	760LM	$\geq 90, R9 > 50$			
LED-25132WR1	12W	3000K	760LM	$\geq 90, R9 > 50$			



## 12W 晶鑽石防眩崁燈



RA90

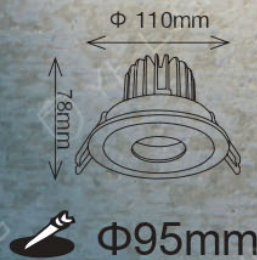

明緯驅動器 / CREE 晶片

## 9.5 公分崁孔

7,500

產品型號	消耗電力	色溫	光通量	演色性	輸入電壓	光束角	燈體材質
LED-25101DR1	12W	6000K	900LM	≥ 80	100-240V (全電壓)	25°	壓鑄鋁 玻璃
LED-25101NR1	12W	4000K	700LM	≥ 90, R9>50			
LED-25101WR1	12W	3000K	700LM	≥ 90, R9>50			



## 12W 黑鑽石炭燈



1. CREE COB 晶片均光且無色偏差
2. 超高演性真實呈現被照物顏色
3.  $R9 \geq 50$ ，對暖色系物品更加鮮艷
4. 採用無頻閃明緯驅動器



明緯驅動器 / CREE 晶片

### 9.5 公分嵌孔

6,500

產品型號	消耗電力	色溫	光通量	演色性	輸入電壓	光束角	燈體材質
LED-9"DOD12D	12W	6500K	800LM	$\geq 80$	100-240V (全電壓)	45°	壓鑄鋁 玻璃
LED-9"DOD12N	12W	4000K	650LM	$\geq 90, R9 > 50$			
LED-9"DOD12W	12W	3000K	650LM	$\geq 90, R9 > 50$			

9W 黑鑽石崁燈



[燈體可轉角 10°]

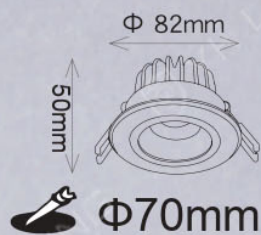

明緯驅動器 / CREE 晶片

7 公分崁孔

5,000

產品型號	消耗電力	色溫	光通量	演色性	輸入電壓	光束角	燈體材質
LED-7DOD9DR1	9W	6500K	450LM	≥ 80	100-240V (全電壓)	30°	壓鑄鋁 玻璃
LED-7DOD9NR1	9W	4000K	400LM	≥ 90, R9>50			
LED-7DOD9WR1	9W	3000K	400LM	≥ 90, R9>50			



## 48W/24W 黑鑽石盒燈



[ 燈體可轉角度 30° ]

1. CREE COB 晶片均光且無色偏差
2. 超高演性真實呈現被照物顏色
3.  $R9 \geq 50$ ，對暖色系物品更加鮮艷
4. 採用無頻閃明緯驅動器

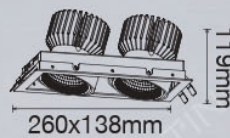

✂️ □245x125mm



明緯驅動器 / CREE 晶片

48W 25,000 24W 20,000

產品型號		消耗電力	色溫	光通量	演色性	輸入電壓	光束角	燈體材質
時尚白	貴族黑							
LED-25130D	LED-25130D-BK	48W	6500K	3100LM	$\geq 80$	100-240V (全電壓)	45°	壓鑄鋁 玻璃
LED-25130N	LED-25130N-BK	48W	4000K	2800LM	$\geq 90, R9>50$			
LED-25130W	LED-25130W-BK	48W	3000K	2800LM	$\geq 90, R9>50$			
LED-25131D	LED-25131D-BK	24W	6500K	1700LM	$\geq 80$			
LED-25131N	LED-25131N-BK	24W	4000K	1400LM	$\geq 90, R9>50$			
LED-25131W	LED-25131W-BK	24W	3000K	1400LM	$\geq 90, R9>50$			

24W/12W 黑鑽石盒燈



RA90



[ 燈體可轉角度 30° ]



138x138mm



□125mm



明緯驅動器 / CREE 晶片

24W **13,000** 12W **11,000**

產品型號	消耗電力	色溫	光通量	演色性	輸入電壓	光束角	燈體材質
LED-25128D	24W	6500K	1500LM	≥ 80	100-240V (全電壓)	45°	壓鑄鋁 玻璃
LED-25128N	24W	4000K	1200LM	≥ 90,R9>50			
LED-25128W	24W	3000K	1200LM	≥ 90,R9>50			
LED-25129D	12W	6500K	900LM	≥ 80			
LED-25129N	12W	4000K	700LM	≥ 90,R9>50			
LED-25129W	12W	3000K	700LM	≥ 90,R9>50			



## 15/9/7 公分三段調色嵌燈



### 隨心所想 隨時切換自己的生理光譜

我們的生理作息深受大自然晝夜色光所影響：早晨的陽光豐沛白光（含有豐沛藍光）喚醒人們，帶來明亮、清醒的步調；隨著日中、日落西下，橘黃的色光暗示放鬆休憩的訊息，天色暗黑觸發人體褪黑激素，提醒我們準備進入夢鄉。

因此人造光的色光選擇不僅是喜好，更要能隨著晝夜調節而切換，為人們帶來更舒適健康的照明。

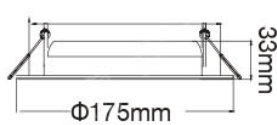

LED-15DOC16SW

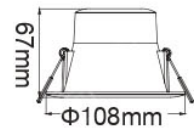
**Φ150mm**

LED-9DOC7SW

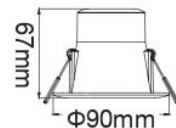
**Φ90mm**

LED-7DOC4SW

**Φ70mm**

15 公分



白光 6500K



自然光 4000K



黃光 3000K



7/9 公分



白光 5700K



自然光 4000K



黃光 3000K







LED-15DOC16SW

LED-9DOC7SW

晶透邊框

LED-7DOC4SW

15 公分嵌孔  壁切

3,800

產品型號	消耗電力	色溫	光通量	演色性	輸入電壓	發光角度	燈體材質
LED-15DOC16SW	16W	6500K 3000K 4000K 壁切三段調色	1600LM	$\geq 80$	100-240V (全電壓)	160°	散熱塑 PC罩

9 公分 / 7 公分嵌孔  壁切

7W 3,800

4W 3,200

產品型號	消耗電力	嵌入孔	色溫	光通量	演色性	輸入電壓	光束角	燈體材質
LED-9DOC7SW	7W	9"	5700K 3000K	600LM	$\geq 80$	100-240V (全電壓)	36°	散熱塑 PC罩
LED-7DOC4SW	4W	7"	4000K 壁切三段調色	300LM				



## 索爾崁燈

1. 一體成型散熱佳
2. 瓦數齊全好應用

3. 三色色溫適合各場所
4. 快速接頭好安裝

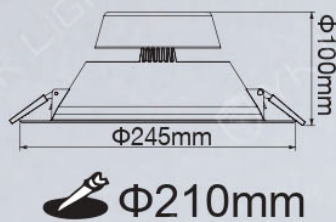

25W 索爾炭燈

挑高  
4米快速  
安裝

Φ210mm



驅動內藏架高好安裝



蜂巢散熱壽命長

21 公分嵌孔

4,500

產品型號	消耗電力	色溫	光通量	演色性	輸入電壓	發光角度	燈體材質
LED-21DOP25D	25W	6000K	2400LM	≥ 80	100-240V (全電壓)	120°	散熱塑 PC 均光罩
LED-21DOP25N	25W	4000K	2400LM				
LED-21DOP25W	25W	3000K	2300LM				

## 12W 索爾節能標章崁燈



節能標章

辦公室及營業場所節能標章  
崁燈及筒燈節能標章

## CNS 認證驅動器

符合 BSMI 無干擾安全標準

## 快速接頭易安裝

安裝的好利器，直接插入無需再纏絕緣膠帶

## 一體成型散熱燈體

使用工業級散熱塑料，能迅速將 LED 所產生的熱導到空氣達到散熱的效果

## 高效率晶片高亮度

採用美國普瑞晶片  
發光效率達 120LM/W

## 高透光率擴散板

94% 透光性，不泛黃不變質，更不會看到 LED 晶片

## 滿板鋁基板無暗區

鋁基板覆蓋在整個燈體底盤上達到最好的散熱效果，且 LED 佈滿在整個鋁基板上讓整燈達到均勻發光無暗區



## 15 公分崁孔

3,500

產品型號	消耗電力	色溫	光通量	演色性	輸入電壓	發光角度	燈體材質
LED-15"DOP12DES	12W	6500K	1450LM	≥ 80	100-240V (全電壓)	160°	散熱塑 PC 罩
LED-15"DOP12WES	12W	3000K	1400LM				





Φ150mm



Φ120mm

## 15 公分崁孔 16W 索爾崁燈

時價

產品型號	LED-15"DOP16DR1 (白光) LED-15"DOP16NR1 (自然光) LED-15"DOP16WR1(黃光)
消耗電力	16W
輸入電壓	100V-240V(全電壓)
色溫	6500K(白光)/4000K(自然光)/3000K(黃光)
光通量	1520LM(白光)/1520LM(自然光)/1440LM(黃光)
發光角度	160°
演色性	≥ 80
燈體材質	散熱塑、PC罩

## 15 公分崁孔 12W 索爾崁燈

時價

產品型號	LED-15"DOP12DR1 (白光) LED-15"DOP12NR1 (自然光) LED-15"DOP12WR1(黃光)
消耗電力	12W
輸入電壓	100V-240V(全電壓)
色溫	6500K(白光)/4000K(自然光)/3000K(黃光)
光通量	1140LM(白光)/1140LM(自然光)/1080LM(黃光)
發光角度	160°
演色性	≥ 80
燈體材質	散熱塑、PC罩

## 12 公分崁孔 12W 索爾崁燈

時價

產品型號	LED-12DOP12DR1 (白光) LED-12DOP12NR1 (自然光) LED-12DOP12WR1(黃光)
消耗電力	12W
輸入電壓	100V-240V(全電壓)
色溫	6500K(白光)/4000K(自然光)/3000K(黃光)
光通量	1140LM(白光)/1140LM(自然光)/1080LM(黃光)
發光角度	160°
演色性	≥ 80
燈體材質	散熱塑、PC罩



1. 一體成形散熱佳
2. 快速接頭更便利
3. 驅動內藏好安裝
4. 黑白燈體百搭裝潢

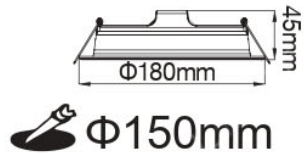

驅動內藏好安裝



快速接頭更便利

## 15 公分嵌孔 奧丁炭燈

時價

產品型號	燈體顏色	消耗電力	色溫	光通量	演色性	輸入電壓	發光角度	燈體材質
LED-15DOP18DR2	時尚白	18W	6500K	1750LM	≥ 80	100-240V (全電壓)	160°	散熱塑 PC罩
LED-15DOP18NR2		18W	4000K	1750LM				
LED-15DOP18WR2		18W	3000K	1660LM				
LED-15DOP16DR2	時尚白	16W	6500K	1550LM				
LED-15DOP16NR2		16W	4000K	1550LM				
LED-15DOP16WR2		16W	3000K	1440LM				
LED-15DOP16DR2B	貴族黑	16W	6500K	1550LM				
LED-15DOP16NR2B		16W	4000K	1550LM				
LED-15DOP16WR2B		16W	3000K	1440LM				
LED-15DOP12DR2	時尚白	12W	6500K	1150LM				
LED-15DOP12NR2		12W	4000K	1150LM				
LED-15DOP12WR2		12W	3000K	1080LM				



16W 微波全日型感應崁燈

微波感應

感應距離 6-8M

亮燈時間 60 秒

24hr 感應



CCAG20LP0320T2  
國家通訊傳播委員會



1. 不受白天黑夜影響，人在感應區就亮燈，離開感應區後 60 秒自動關燈，讓使用空間達到自動節電效果
2. 不受灰塵、小蟲等物體影響，抗干擾能力強
3. 適用高度為 3 米，感應區直徑 6-8 米
4. 燈具之間的安裝距離為 2 米以上

15 公分崁孔

4,000

產品型號	消耗電力	色溫	光通量	演色性	輸入電壓	發光角度	燈體材質
LED-15DOP16DMS	16W	6500K	1550LM	≥ 80	100-240V (全電壓)	160°	散熱塑 PC 罩
LED-15DOP16NMS	16W	4000K	1550LM				
LED-15DOP16WMS	16W	3000K	1430LM				



## 歡笑投射崁燈



RA90

&lt; 2022 Q2 上市 &gt;



1. 驅動器內藏好安裝

2. 高演色性真實呈現被照物顏色

4. 快速接頭好安裝

5. 三色色溫好運用





[燈體可調角度 30°]

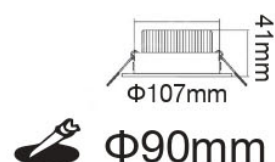

Φ90mm

### 9 公分崁孔 8W 歡笑崁燈

時價

產品型號	燈體顏色	消耗電力	色溫	光通量	演色性	輸入電壓	光束角	燈體材質
LED-9DOL8D	時尚白	8W	6000K	680LM	≥ 90	100-240V (全電壓)	36°	塑包鋁 PMMA
LED-9DOL8N		8W	4000K	650LM				
LED-9DOL8W		8W	3000K	650LM				
LED-9DOL8D-BK	貴族黑	8W	6000K	680LM	≥ 90			
LED-9DOL8N-BK		8W	4000K	650LM				
LED-9DOL8W-BK		8W	3000K	650LM				



[燈體可調角度 30°]

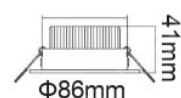

Φ70mm

### 7 公分崁孔 5W 歡笑崁燈

時價

產品型號	燈體顏色	消耗電力	色溫	光通量	演色性	輸入電壓	光束角	燈體材質
LED-7DOL5D	時尚白	5W	6000K	400LM	≥ 90	100-240V (全電壓)	36°	塑包鋁 PMMA
LED-7DOL5N		5W	4000K	390LM				
LED-7DOL5W		5W	3000K	390LM				
LED-7DOL5D-BK	貴族黑	5W	6000K	400LM	≥ 90			
LED-7DOL5N-BK		5W	4000K	390LM				
LED-7DOL5W-BK		5W	3000K	390LM				



# 浩瀚 / 浩克嵌燈



[燈體可調角度 30°]

1. 驅動內藏好安裝 (3W 驅動外置)
2. 滿板基板無暗區

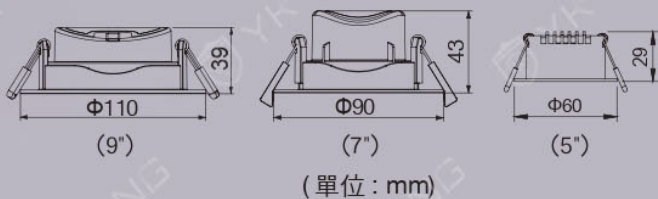

浩克氣氛光重點照明

浩瀚環境光基礎照明



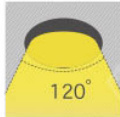

9 公分 / 7 公分廣角浩瀚崁燈

9" 2,500 7" 2,000

產品型號	燈體顏色	消耗電力	嵌入孔	色溫	光通量	演色性	輸入電壓	發光角度	燈體材質
LED-9DOHUB8DR1	時尚白	8W	9"	6500K	745LM	≥ 80 R9>0	100-240V (全電壓)	120°	塑包鋁
LED-9DOHUB8NR1		8W	9"	4000K	745LM				
LED-9DOHUB8WR1		8W	9"	3000K	720LM				
LED-7DOHUB5D		5W	7"	6000K	425LM				
LED-7DOHUB5N		5W	7"	4000K	425LM				
LED-7DOHUB5W		5W	7"	3000K	390LM				

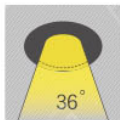

9 公分窄角浩克崁燈

2,500

產品型號	燈體顏色	消耗電力	色溫	光通量	演色性	輸入電壓	光束角	燈體材質
LED-9DOHU8DR1	時尚白	8W	6500K	760LM	≥ 80 R9>0	100-240V (全電壓)	36°	塑包鋁
LED-9DOHU8NR1		8W	4000K	760LM				
LED-9DOHU8WR1		8W	3000K	745LM				
LED-9DOHU8DR1 BK	貴族黑	8W	6500K	760LM				
LED-9DOHU8NR1 BK		8W	4000K	760LM				
LED-9DOHU8WR1 BK		8W	3000K	745LM				

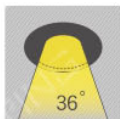

7 公分 / 5 公分窄角浩克崁燈

2,000

產品型號	消耗電力	嵌入孔	色溫	光通量	演色性	輸入電壓	光束角	燈體材質
LED-7DOHU5D	5W	7"	6000K	450LM	≥ 80 R9>0	100-240V (全電壓)	36°	塑包鋁
LED-7DOHU5N	5W	7"	4000K	450LM				
LED-7DOHU5W	5W	7"	3000K	420LM				
LED-5DOHU3W	3W	5"	3000K	200LM			30°	



## 微笑投射崁燈



[燈體可調角度 30°]



防眩設計

1. 專利散熱鋁設計
2. 快速接頭好安裝
3. 三色色溫好運用
4. 防眩設計不刺眼

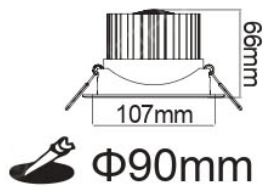

含快速接頭



加高散熱座

### 9 公分崁孔 15W 微笑崁燈

5,000

產品型號	燈體顏色	消耗電力	色溫	光通量	演色性	輸入電壓	光束角	燈體材質
LED-9DOS15D	時尚白	15W	6000K	1100LM	$\geq 80, R9 > 0$	100-240V (全電壓)	15°	壓鑄鋁質 PC
LED-9DOS15N		15W	4000K	1050LM				
LED-9DOS15W		15W	3000K	1000LM				
LED-9DOS15D-BK	貴族黑	15W	6000K	1100LM	$\geq 80, R9 > 0$			
LED-9DOS15N-BK		15W	4000K	1050LM				
LED-9DOS15W-BK		15W	3000K	1000LM				



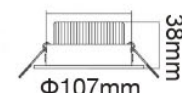

[燈體可調角度 30°]

專利散熱鋁設計  
高光維持率
  $\Phi 90\text{mm}$ 

### 9 公分崁孔 8W 微笑崁燈

時價

產品型號	燈體顏色	消耗電力	色溫	光通量	演色性	輸入電壓	光束角	燈體材質
LED-25090DR2	時尚白	8W	6000K	750LM	$\geq 80, R9 > 0$	100-240V (全電壓)	18°	壓鑄鋁 PC
LED-25090NR2		8W	4000K	715LM				
LED-25090WR2		8W	3000K	715LM				
LED-25090DR2-BK	貴族黑	8W	6000K	750LM	$\geq 80, R9 > 0$			
LED-25090NR2-BK		8W	4000K	715LM				
LED-25090WR2-BK		8W	3000K	715LM				



[燈體可調角度 30°]

  $\Phi 70\text{mm}$ 

### 7 公分崁孔 5W 微笑崁燈

時價

產品型號	燈體顏色	消耗電力	色溫	光通量	演色性	輸入電壓	光束角	燈體材質
LED-25097DR1	時尚白	5W	6000K	415LM	$\geq 80, R9 > 0$	100-240V (全電壓)	18°	壓鑄鋁 PC
LED-25097NR1		5W	4000K	385LM				
LED-25097WR1		5W	3000K	385LM				
LED-25097DR1-BK	貴族黑	5W	6000K	415LM	$\geq 80, R9 > 0$			
LED-25097NR1-BK		5W	4000K	385LM				
LED-25097WR1-BK		5W	3000K	385LM				

## 超薄方型嵌燈



LED-25068-BK 3,500



LED-25068 3,500



LED-25067-BK 2,000



LED-25067 2,000

1. 高度為 40mm，適合運用在較窄的裝潢空間
2. 無後蓋設計，散熱較佳

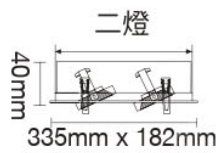

□317mmx170mm

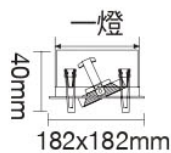

□170mmx170mm



產品型號	燈體顏色	燈數	適用光源	燈體材質
LED-25068	時尚白	二燈	LED AR111 14W x2 另計 或 LED AR111 9W x2 另計	外框：鋁材 內框：鐵材
LED-25068-BK	貴族黑			
LED-25067	時尚白	一燈	LED AR111 14W x1 另計 或 LED AR111 9W x1 另計	
LED-25067-BK	貴族黑			





311x311mm

無邊框 AR 四燈嵌燈

時價

產品型號	LED-25061-WR
燈數	四燈
適用光源	LED AR111 x 4 另計
燈體材質	鐵材黑色烤漆



461x161mm

無邊框 AR 三燈嵌燈

時價

產品型號	LED-25062-WR
燈數	三燈
適用光源	LED AR111 x 3 另計
燈體材質	鐵材黑色烤漆



311x161mm

無邊框 AR 二燈嵌燈

時價

產品型號	LED-25063-WR
燈數	二燈
適用光源	LED AR111 x 2 另計
燈體材質	鐵材黑色烤漆



161x161mm

無邊框 AR 一燈嵌燈

時價

產品型號	LED-25064-WR
燈數	一燈
適用光源	LED AR111 x 1 另計
燈體材質	鐵材黑色烤漆



191x99mm

無邊框 MR 二燈嵌燈

時價

產品型號	LED-25063-MR16
燈數	二燈
適用光源	LED MR16 x 2 另計
燈體材質	鐵材黑色烤漆

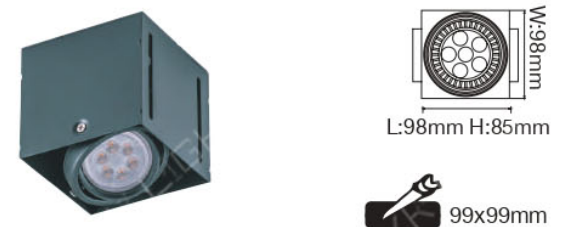

99x99mm

無邊框 MR 一燈嵌燈

時價

產品型號	LED-25064-MR16
燈數	一燈
適用光源	LED MR16 x 1 另計
燈體材質	鐵材黑色烤漆



### 白框 AR 四燈嵌燈

時價

產品型號	DL-31015W-WR
燈數	四燈
適用光源	LED AR111X4 另計
燈體材質	鐵材白色烤漆
※另有黑色款 (DL-31015-BK)	



### 白框 AR 三燈嵌燈

時價

產品型號	DL-31017W-WR
燈數	三燈
適用光源	LED AR111X3 另計
燈體材質	鐵材白色烤漆
※另有黑色款 (DL-31017-BK)	



### 白框 AR 二燈嵌燈

時價

產品型號	DL-31018W-WR
燈數	二燈
適用光源	LED AR111X2 另計
燈體材質	鐵材白色烤漆



### 白框 AR 一燈嵌燈

時價

產品型號	DL-31019W-WR
燈數	一燈
適用光源	LED AR111X1 另計
燈體材質	鐵材白色烤漆



### 黑框 AR 二燈嵌燈

時價

產品型號	DL-31018-BK
燈數	二燈
適用光源	LED AR111X2 另計
燈體材質	鐵材黑色烤漆



### 黑框 AR 一燈嵌燈

時價

產品型號	DL-31019-BK
燈數	一燈
適用光源	LED AR111X1 另計
燈體材質	鐵材黑色烤漆





Φ90mm

### MR 可轉角防眩嵌燈 2,200

產品型號	LED-9"RE002
適用光源	MR16 x1 另計
尺寸	φ 100 H: 45mm
燈體材質	壓鑄鋁、時尚白



Φ90mm

### MR 可轉角防眩嵌燈 2,200

產品型號	LED-9"RE002-BK
適用光源	MR16 x1 另計
尺寸	φ 100 H: 45mm
燈體材質	壓鑄鋁、貴族黑



Φ70mm

### MR 防眩嵌燈 1,100

產品型號	LED-7"RE002
適用光源	MR16 x1 另計
尺寸	φ 82 H: 41mm
燈體材質	壓鑄鋁、時尚白



Φ70mm

### MR 防眩嵌燈 1,100

產品型號	LED-7"RE002-BK
適用光源	MR16 x1 另計
尺寸	φ 82 H: 41mm
燈體材質	壓鑄鋁、貴族黑





  $\Phi 70\text{mm}$

### MR 可轉角崁燈 時價

產品型號	KW-303
適用光源	MR16x1 另計
尺寸	$\phi$ 88 H:25mm
燈體材質	白色鐵烤漆



  $\Phi 70\text{mm}$

### MR 可轉角崁燈 時價

產品型號	KW-303-BK
適用光源	MR16x1 另計
尺寸	$\phi$ 88 H:25mm
燈體材質	黑色鐵烤漆



  $\Phi 75\text{mm}$

### MR 可轉角崁燈 時價

產品型號	KW-301
適用光源	MR16x1 另計
尺寸	$\phi$ 85 H:25mm
燈體材質	白色鋁烤漆



  $\Phi 90\text{mm}$

### MR 可轉角崁燈 時價

產品型號	KW-314
適用光源	MR16 X1 另計
尺寸	$\phi$ 105 x H 37mm
燈體材質	白色鐵烤漆



  $\Phi 150\text{mm}$

### AR 可轉角崁燈 時價

產品型號	KW-722
適用光源	AR111 X1 另計
尺寸	$\phi$ 180 x H 62mm
燈體材質	白色鐵烤漆



## 黛安娜變焦軌道燈



## 博物館燈的光品質

1. 光束角可任意變焦調整
2. 防眩設計不刺眼
3. 黑白兩色百搭任何場所
4. 無閃頻設計

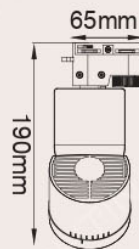

光源刻度



光束角可調

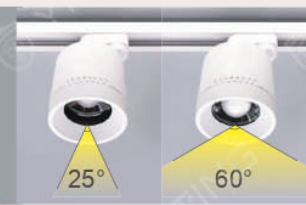

變焦光源示意



燈頭可調 90°



9,000

產品型號	燈體顏色	消耗電力	色溫	光通量	演色性	輸入電壓	光束角	燈體材質
LED-TR15WAA	時尚白	15W	3000K	850-1050LM	≥ 90, R9>50	100-240V (全電壓)	25° ~ 60° (可調整)	鋁壓鑄 PC
LED-TR15WAA-BK	貴族黑	15W	3000K	850-1050LM	≥ 90, R9>50			



## 黑鑽石軌道燈



1. 世界大廠晶片均光且無色偏差
2. 超高演色性真實呈現被照物顏色

3.  $R9 > 50$ , 對暖色系物品更加鮮艷
4. 採用高品質世界大廠驅動器



45W 黑鑽石軌道燈

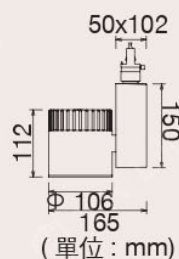

PHILIPS 驅動器 / 晶片

19,000

產品型號	燈體顏色	消耗電力	色溫	光通量	演色性	輸入電壓	光束角	燈體材質
LED-TR45DFLR1	時尚白	45W	5000K	3600LM	≥ 80	100-240V (全電壓)	30°	壓鑄鋁 玻璃
LED-TR45NFLR1		45W	4000K	3100LM	≥ 90, R9>50			
LED-TR45WFLR1		45W	3000K	3100LM	≥ 90, R9>50			
LED-TR45DFLBKR1	貴族黑	45W	5000K	3600LM	≥ 80			
LED-TR45NFLBKR1		45W	4000K	3100LM	≥ 90, R9>50			
LED-TR45WFLBKR1		45W	3000K	3100LM	≥ 90, R9>50			

## 30W 黑鑽石軌道燈

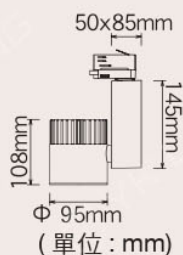

PHILIPS 驅動器 / 晶片

15,000

產品型號	燈體顏色	消耗電力	色溫	光通量	演色性	輸入電壓	光束角	燈體材質
LED-TR30DFLR1	時尚白	30W	5000K	2400LM	≥ 80	100-240V (全電壓)	24°	壓鑄鋁 玻璃
LED-TR30NFLR1		30W	4000K	2050LM	≥ 90, R9>50			
LED-TR30WFLR1		30W	3000K	2050LM	≥ 90, R9>50			
LED-TR30DFLBKR1	貴族黑	30W	5000K	2400LM	≥ 80			
LED-TR30NFLBKR1		30W	4000K	2050LM	≥ 90, R9>50			
LED-TR30WFLBKR1		30W	3000K	2050LM	≥ 90, R9>50			



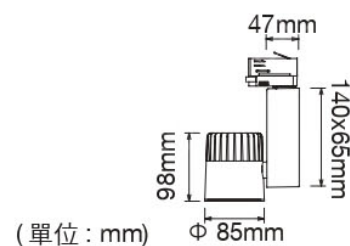

明緯驅動器 / CREE 晶片

13,000

## 24W 黑鑽石軌道燈

產品型號	燈體顏色	消耗電力	色溫	光通量	演色性	輸入電壓	光束角	燈體材質
LED-TR24DFL	時尚白	24W	6000K	1500LM	$\geq 80$	100-240V (全電壓)	45°	壓鑄鋁 玻璃
LED-TR24NFL		24W	4000K	1200LM	$\geq 90, R9 > 50$			
LED-TR24WFL		24W	3000K	1200LM	$\geq 90, R9 > 50$			
LED-TR24DFL-BK	貴族黑	24W	6000K	1500LM	$\geq 80$			
LED-TR24NFL-BK		24W	4000K	1200LM	$\geq 90, R9 > 50$			
LED-TR24WFL-BK		24W	3000K	1200LM	$\geq 90, R9 > 50$			

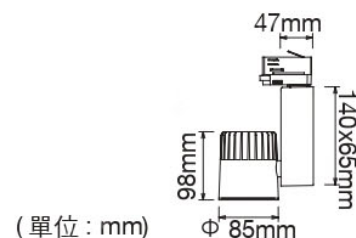

明緯驅動器 / CREE 晶片

11,000

## 12W 黑鑽石軌道燈

產品型號	燈體顏色	消耗電力	色溫	光通量	演色性	輸入電壓	光束角	燈體材質
LED-TR12DFL	時尚白	12W	6000K	900LM	$\geq 80$	100-240V (全電壓)	45°	壓鑄鋁 玻璃
LED-TR12NFL		12W	4000K	700LM	$\geq 90, R9 > 50$			
LED-TR12WFL		12W	3000K	700LM	$\geq 90, R9 > 50$			
LED-TR12DFL-BK	貴族黑	12W	6000K	900LM	$\geq 80$			
LED-TR12NFL-BK		12W	4000K	700LM	$\geq 90, R9 > 50$			
LED-TR12WFL-BK		12W	3000K	700LM	$\geq 90, R9 > 50$			

## 15W 微笑軌道燈

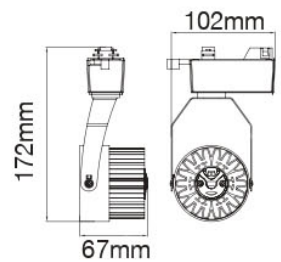

1. 專利散熱鋁設計
2. 黑白兩色，百搭裝潢
3. 高演色，完美光型
4. 防眩設計不刺眼

4,500

產品型號	燈體顏色	消耗電力	色溫	光通量	演色性	輸入電壓	光束角	燈體材質
LED-TRSM15DR1	時尚白	15W	6000K	1100LM	$\geq 80, R9 > 0$	100-240V (全電壓)	15°	壓鑄鋁 PC
LED-TRSM15NR1		15W	4000K	1050LM	$\geq 80, R9 > 0$			
LED-TRSM15WR1		15W	3000K	1000LM	$\geq 80, R9 > 0$			
LED-TRSM15DR1BK	貴族黑	15W	6000K	1100LM	$\geq 80, R9 > 0$			
LED-TRSM15NR1BK		15W	4000K	1050LM	$\geq 80, R9 > 0$			
LED-TRSM15WR1BK		15W	3000K	1000LM	$\geq 80, R9 > 0$			



## 8W 微笑軌道燈

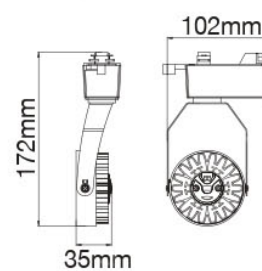

1. 專利散熱鋁設計
2. 黑白兩色，百搭裝潢
3. 高演色，完美光型

2,500

產品型號	燈體顏色	消耗電力	色溫	光通量	演色性	輸入電壓	光束角	燈體材質
LED-TRSM8D	時尚白	8W	6000K	750LM	$\geq 80, R9 > 0$	100-240V (全電壓)	18°	壓鑄鋁 PC
LED-TRSM8N		8W	4000K	715LM	$\geq 80, R9 > 0$			
LED-TRSM8W		8W	3000K	715LM	$\geq 80, R9 > 0$			
LED-TRSM8D-BK	貴族黑	8W	6000K	750LM	$\geq 80, R9 > 0$			
LED-TRSM8N-BK		8W	4000K	715LM	$\geq 80, R9 > 0$			
LED-TRSM8W-BK		8W	3000K	715LM	$\geq 80, R9 > 0$			





## 邱比特軌道燈



7W/15W



1. 採用 CREE 晶片均光且無色偏差
2. 一體成型輕巧時尚
3. 防眩設計不刺眼

4. 色溫齊全好運用
5. 黑白兩色百搭任何場所





## 30W 邱比特軌道燈

11,000

產品型號	燈體顏色	消耗電力	色溫	光通量	演色性	輸入電壓	光束角	燈體材質
LED-TRCP30D	時尚白	30W	6500K	2250LM	$\geq 80, R9>0$	100-240V (全電壓)	36°	壓鑄鋁 PC
LED-TRCP30N		30W	4000K	2250LM	$\geq 80, R9>0$			
LED-TRCP30W		30W	3000K	2100LM	$\geq 80, R9>0$			
LED-TRCP30D-BK	貴族黑	30W	6500K	2250LM	$\geq 80, R9>0$			
LED-TRCP30N-BK		30W	4000K	2250LM	$\geq 80, R9>0$			
LED-TRCP30W-BK		30W	3000K	2100LM	$\geq 80, R9>0$			



## 20W 邱比特軌道燈

7,500

產品型號	燈體顏色	消耗電力	色溫	光通量	演色性	輸入電壓	光束角	燈體材質
LED-TRCP20D	時尚白	20W	6500K	1500LM	$\geq 80, R9>0$	100-240V (全電壓)	36°	壓鑄鋁 PC
LED-TRCP20N		20W	4000K	1500LM	$\geq 80, R9>0$			
LED-TRCP20W		20W	3000K	1400LM	$\geq 80, R9>0$			
LED-TRCP20D-BK	貴族黑	20W	6500K	1500LM	$\geq 80, R9>0$			
LED-TRCP20N-BK		20W	4000K	1500LM	$\geq 80, R9>0$			
LED-TRCP20W-BK		20W	3000K	1400LM	$\geq 80, R9>0$			



## 15W 邱比特軌道燈

6,000

產品型號	燈體顏色	消耗電力	色溫	光通量	演色性	輸入電壓	光束角	燈體材質
LED-TRCP15DR1	時尚白	15W	6500K	1200LM	$\geq 80, R9 > 0$	100-240V (全電壓)	36°	壓鑄鋁 PC
LED-TRCP15NR1		15W	4000K	1200LM	$\geq 80, R9 > 0$			
LED-TRCP15WR1		15W	3000K	1150LM	$\geq 80, R9 > 0$			
LED-TRCP15D-BK	貴族黑	15W	6500K	1200LM	$\geq 80, R9 > 0$			
LED-TRCP15N-BK		15W	4000K	1200LM	$\geq 80, R9 > 0$			
LED-TRCP15W-BK		15W	3000K	1150LM	$\geq 80, R9 > 0$			



## 7W 邱比特軌道燈

3,000

產品型號	燈體顏色	消耗電力	色溫	光通量	演色性	輸入電壓	光束角	燈體材質
LED-TRCP7DR1	時尚白	7W	6500K	500LM	$\geq 80, R9 > 0$	100-240V (全電壓)	30°	壓鑄鋁 PC
LED-TRCP7NR1		7W	4000K	500LM	$\geq 80, R9 > 0$			
LED-TRCP7WR1		7W	3000K	450LM	$\geq 80, R9 > 0$			
LED-TRCP7D-BK	貴族黑	7W	6500K	500LM	$\geq 80, R9 > 0$			
LED-TRCP7N-BK		7W	4000K	500LM	$\geq 80, R9 > 0$			
LED-TRCP7W-BK		7W	3000K	450LM	$\geq 80, R9 > 0$			



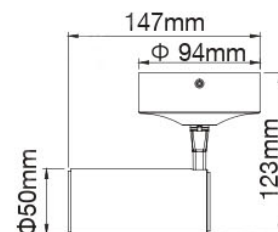

## 15W 邱比特吸頂燈

6,000

產品型號	燈體顏色	消耗電力	色溫	光通量	演色性	輸入電壓	光束角	燈體材質
LED-CCP15WR1	時尚白	15W	3000K	1150LM	$\geq 80, R9 > 0$	100-240V (全電壓)	36°	壓鑄鋁 PC
LED-CCP15W-BK	貴族黑							

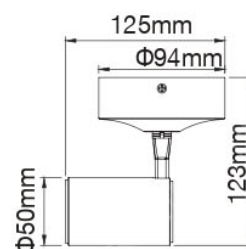

## 7W 邱比特吸頂燈

3,000

產品型號	燈體顏色	消耗電力	色溫	光通量	演色性	輸入電壓	光束角	燈體材質
LED-CCP7WR1	時尚白	7W	3000K	450LM	$\geq 80, R9 > 0$	100-240V (全電壓)	30°	壓鑄鋁 PC
LED-CCP7W-BK	貴族黑							

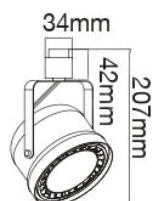

&lt; 2022 Q2 上市 &gt;

時價

產品型號	LED-ATRASP14D(N)(W)(14W 投射型) LED-ATRAFL14D(N)(W)(14W 基礎型) LED-ATRASP9D(N)(W)(9W 投射型)
烤 漆	時尚白
適用光源	LED AR111 14W 或 9W X1
燈體材質	鐵材烤漆、耐熱 PC 軌道盒
固定方式	軌道式



&lt; 2022 Q2 上市 &gt;

時價

產品型號	LED-ATRASP14D(N)(W)BK(14W 投射型) LED-ATRAFL14D(N)(W)BK(14W 基礎型) LED-ATRASP9D(N)(W)-BK(9W 投射型)
烤 漆	貴族黑
適用光源	LED AR111 14W 或 9W X1
燈體材質	鐵材烤漆、耐熱 PC 軌道盒
固定方式	軌道式

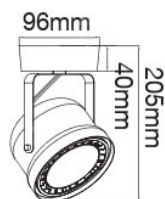

&lt; 2022 Q2 上市 &gt;

時價

產品型號	LED-ACASP14D(N)(W)(14W 投射型) LED-ACAFL14D(N)(W)(14W 基礎型) LED-ACASP9D(N)(W)(9W 投射型)
烤 漆	時尚白
適用光源	LED AR111 14W 或 9W X1
燈體材質	鐵材烤漆、耐熱 PC 軌道盒
固定方式	吸頂式



&lt; 2022 Q2 上市 &gt;

時價

產品型號	LED-ACASP14D(N)(W)-BK(14W 投射型) LED-ACAFL14D(N)(W)-BK(14W 基礎型) LED-ACASP9D(N)(W)-BK(9W 投射型)
烤 漆	貴族黑
適用光源	LED AR111 14W 或 9W X1
燈體材質	鐵材烤漆、耐熱 PC 軌道盒
固定方式	吸頂式





時價

時價

產品型號	LED-24023-14SPD(N)(W)(14W 投射型) LED-24023-14FLD(N)(W)(14W 基礎型) LED-24023-9SPD(N)(W)(9W 投射型)
烤漆	時尚白
適用光源	LED AR111 14W 或 9W X1
燈體材質	鐵材烤漆、耐熱 PC 軌道盒
固定方式	軌道式

產品型號	LED-24022-14SPD(N)(W)(14W 投射型) LED-24022-14FLD(N)(W)(14W 基礎型) LED-24022-9SPD(N)(W)(9W 投射型)
烤漆	貴族黑
適用光源	LED AR111 14W 或 9W X1
燈體材質	鐵材烤漆、耐熱 PC 軌道盒
固定方式	軌道式



軌道 I 字接頭  
DLG-I/BR1(黑)  
DLG-I/WR1(白)



軌道 L 字接頭  
DLG-L/BR1(黑)  
DLG-L/WR1(白)

軌道 T 字接頭  
DLG-T/BR1(黑)  
DLG-T/WR1(白)



軌道十字接頭  
DLG-+/BR1(黑)  
DLG-+/WR1(白)

產品型號	燈體長度	燈體顏色	尺寸	燈體材質
DLL-1M/WR1	1 米	時尚白	L:1000mm W:34mm H:21mm	鋁合金
DLL-1.5M/WR1	1.5 米		L:1500mm W:34mm H:21mm	
DLL-2M/WR1	2 米		L:2000mm W:34mm H:21mm	
DLL-3M/WR1	3 米		L:3000mm W:34mm H:21mm	
DLL-1M/BR1	1 米	貴族黑	L:1000mm W:34mm H:21mm	
DLL-1.5M/BR1	1.5 米		L:1500mm W:34mm H:21mm	
DLL-2M/BR1	2 米		L:2000mm W:34mm H:21mm	
DLL-3M/BR1	3 米		L:3000mm W:34mm H:21mm	



時價

產品型號	LED-24002D(N)(W)-NPR1
烤 漆	時尚白
適用光源	附 LED MR16 6W 免驅 X1
燈體材質	鐵材烤漆、耐熱 PC 軌道盒
固定方式	軌道式

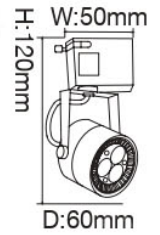

時價

產品型號	LED-24001D(N)(W)-NPR1
烤 漆	貴族黑
適用光源	附 LED MR16 6W 免驅 X1
燈體材質	鐵材烤漆、耐熱 PC 軌道盒
固定方式	軌道式



時價

產品型號	LED-24002
烤 漆	時尚白
適用光源	LED MR16 8W X1 另計 或 LED MR16 6W X1 另計
燈體材質	鐵材烤漆、耐熱 PC 軌道盒
固定方式	軌道式

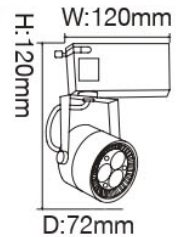

時價

產品型號	LED-24001
烤 漆	貴族黑
適用光源	LED MR16 8W X1 另計 或 LED MR16 6W X1 另計
燈體材質	鐵材烤漆、耐熱 PC 軌道盒
固定方式	軌道式



時價

產品型號	LED-24002C
烤 漆	時尚白
適用光源	LED MR16 8W X1 另計 或 LED MR16 6W X1 另計
燈體材質	鐵材烤漆、耐熱 PC 軌道盒
固定方式	吸頂式



時價

產品型號	LED-24001C
烤 漆	貴族黑
適用光源	LED MR16 8W X1 另計 或 LED MR16 6W X1 另計
燈體材質	鐵材烤漆、耐熱 PC 軌道盒
固定方式	吸頂式





防眩設計

5,200

防眩設計

5,200

產品型號	LED-24018
烤 漆	時尚白
適用光源	LED-MR16 6W X1 另計 或 LED-MR16 8W X1 另計
燈體材質	鐵材烤漆、耐熱 PC 軌道盒
固定方式	軌道式

產品型號	LED-24019
烤 漆	貴族黑
適用光源	LED-MR16 6W X1 另計 或 LED-MR16 8W X1 另計
燈體材質	鐵材烤漆、耐熱 PC 軌道盒
固定方式	軌道式



可轉角 30°

4,800

可轉角 30°

4,800

產品型號	LED-24016
烤 漆	時尚白
適用光源	LED-MR16 6W X1 另計 或 LED-MR16 8W X1 另計
燈體材質	鐵材烤漆、耐熱 PC 軌道盒
固定方式	軌道式

產品型號	LED-24017
烤 漆	貴族黑
適用光源	LED-MR16 6W X1 另計 或 LED-MR16 8W X1 另計
燈體材質	鐵材烤漆、耐熱 PC 軌道盒
固定方式	軌道式



## 黑鑽石吸頂筒燈



1. 45W/ 30W 飛利浦 COB 晶片，均光無色差

2. 超高演色性真實呈現被照物顏色

3. R9>50, 對暖色系物品更加鮮艷

4. 45W/ 30W 採用飛利浦無頻閃驅動器

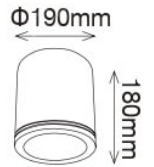

適用  
6米

25,000

## 45W 黑鑽石吸頂筒燈

產品型號	燈體顏色	消耗電力	色溫	光通量	演色性	輸入電壓	光束角	燈體材質
LED-CEB45DR1	時尚白	45W	5000K	3500LM	$\geq 80$	100-240V (全電壓)	35°	壓鑄鋁 玻璃
LED-CEB45NR1		45W	4000K	2800LM	$\geq 90, R9>50$			
LED-CEB45WR1		45W	3000K	2800LM	$\geq 90, R9>50$			
LED-CEB45DBKR1	貴族黑	45W	5000K	3500LM	$\geq 80$			
LED-CEB45NBKR1		45W	4000K	2800LM	$\geq 90, R9>50$			
LED-CEB45WBKR1		45W	3000K	2800LM	$\geq 90, R9>50$			

適用  
5米

21,000

## 30W 黑鑽石吸頂筒燈

產品型號	燈體顏色	消耗電力	色溫	光通量	演色性	輸入電壓	光束角	燈體材質
LED-CEB30DR1	時尚白	30W	5000K	2500LM	$\geq 80$	100-240V (全電壓)	35°	壓鑄鋁 玻璃
LED-CEB30NR1		30W	4000K	2100LM	$\geq 90, R9>50$			
LED-CEB30WR1		30W	3000K	2100LM	$\geq 90, R9>50$			
LED-CEB30DBKR1	貴族黑	30W	5000K	2500LM	$\geq 80$			
LED-CEB30NBKR1		30W	4000K	2100LM	$\geq 90, R9>50$			
LED-CEB30WBKR1		30W	3000K	2100LM	$\geq 90, R9>50$			

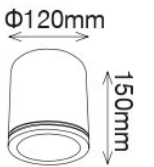
適用  
3米

15,000

## 24W 黑鑽石吸頂筒燈

產品型號	燈體顏色	消耗電力	色溫	光通量	演色性	輸入電壓	光束角	燈體材質
LED-CEB24D	時尚白	24W	6000K	1400LM	$\geq 80$	100-240V (全電壓)	45°	壓鑄鋁 玻璃
LED-CEB24N		24W	4000K	1300LM	$\geq 90, R9>50$			
LED-CEB24W		24W	3000K	1300LM	$\geq 90, R9>50$			
LED-CEB24D-BK	貴族黑	24W	6000K	1400LM	$\geq 80$			
LED-CEB24N-BK		24W	4000K	1300LM	$\geq 90, R9>50$			
LED-CEB24W-BK		24W	3000K	1300LM	$\geq 90, R9>50$			



## 神盾吸頂筒燈



RA90



1. 採用普瑞 COB 晶片，均光無色差
2. 色溫齊全好應用

3. 壓鑄鋁一體成型散熱好
4. 旋式壁板好安裝

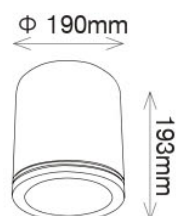

適用  
6米

18,000

## 40W 神盾吸頂筒燈

產品型號	燈體顏色	消耗電力	色溫	光通量	演色性	輸入電壓	光束角	燈體材質
LED-CEA40D	時尚白	40W	6000K	4000LM	$\geq 80$	100-240V (全電壓)	36°	壓鑄鋁 壓克力
LED-CEA40N		40W	4000K	3400LM	$\geq 90, R9>0$			
LED-CEA40W		40W	3000K	3400LM	$\geq 90, R9>0$			
LED-CEA40D-BK	貴族黑	40W	6000K	4000LM	$\geq 80$			
LED-CEA40N-BK		40W	4000K	3400LM	$\geq 90, R9>0$			
LED-CEA40W-BK		40W	3000K	3400LM	$\geq 90, R9>0$			

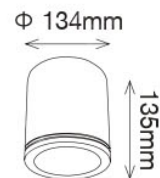
適用  
5米

12,500

## 30W 神盾吸頂筒燈

產品型號	燈體顏色	消耗電力	色溫	光通量	演色性	輸入電壓	光束角	燈體材質
LED-CEA30D	時尚白	30W	6000K	3000LM	$\geq 80$	100-240V (全電壓)	36°	壓鑄鋁 壓克力
LED-CEA30N		30W	4000K	2600LM	$\geq 90, R9>0$			
LED-CEA30W		30W	3000K	2600LM	$\geq 90, R9>0$			
LED-CEA30D-BK	貴族黑	30W	6000K	3000LM	$\geq 80$			
LED-CEA30N-BK		30W	4000K	2600LM	$\geq 90, R9>0$			
LED-CEA30W-BK		30W	3000K	2600LM	$\geq 90, R9>0$			

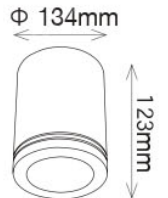
適用  
3米

## 20W 神盾吸頂筒燈

9,000

產品型號	燈體顏色	消耗電力	色溫	光通量	演色性	輸入電壓	光束角	燈體材質
LED-CEA20D	時尚白	20W	6000K	2000LM	$\geq 80$	100-240V (全電壓)	36°	壓鑄鋁 壓克力
LED-CEA20N		20W	4000K	1600LM	$\geq 90, R9>0$			
LED-CEA20W		20W	3000K	1600LM	$\geq 90, R9>0$			
LED-CEA20D-BK	貴族黑	20W	6000K	2000LM	$\geq 80$			
LED-CEA20N-BK		20W	4000K	1600LM	$\geq 90, R9>0$			
LED-CEA20W-BK		20W	3000K	1600LM	$\geq 90, R9>0$			

適用  
2米

## 10W 神盾吸頂筒燈

6,300

產品型號	燈體顏色	消耗電力	色溫	光通量	演色性	輸入電壓	光束角	燈體材質
LED-CEA10D	時尚白	10W	6000K	1000LM	$\geq 80$	100-240V (全電壓)	36°	壓鑄鋁 壓克力
LED-CEA10N		10W	4000K	700LM	$\geq 90, R9>0$			
LED-CEA10W		10W	3000K	700LM	$\geq 90, R9>0$			
LED-CEA10D-BK	貴族黑	10W	6000K	1000LM	$\geq 80$			
LED-CEA10N-BK		10W	4000K	700LM	$\geq 90, R9>0$			
LED-CEA10W-BK		10W	3000K	700LM	$\geq 90, R9>0$			





## 替換式吸頂筒燈



燈泡另計

1,800

## MR16 吸頂筒燈

產品型號	LED-25001
適用光源	LED MR16 8W x1 另計 或 LED MR16 6W x1 另計
尺寸	Φ 110mm H:115mm
燈體材質	鐵材白色烤漆



燈泡另計

1,800

## MR16 吸頂筒燈

產品型號	LED-25001-BK
適用光源	LED MR16 8W x1 另計 或 LED MR16 6W x1 另計
尺寸	Φ 110mm H:115mm
燈體材質	鐵材黑色烤漆



燈泡另計

2,500

## AR111 吸頂筒燈

產品型號	LED-25002
適用光源	LED AR111 14W x1 另計 或 LED AR111 9W x1 另計
尺寸	Φ 160mm H:140mm
燈體材質	鐵材白色烤漆



燈泡另計

2,500

## AR111 吸頂筒燈

產品型號	LED-25002-BK
適用光源	LED AR111 14W x1 另計 或 LED AR111 9W x1 另計
尺寸	Φ 160mm H:140mm
燈體材質	鐵材黑色烤漆

# 居家照明

## 和風系列



CCAO20LP1210T2  
國家通訊傳播委員會



無藍光  
危害

調光  
調色

適用  
6~8 坪

單色  
足瓦



樟木紋



四段壁切



**單色足瓦：**  
每個色溫均達最高亮度，  
變色不變暗

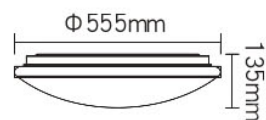

### 50W 和風調光雅緻吸頂燈

✓ 遙控

✓ 壁切

43,000

產品型號	燈體顏色	消耗電力	色溫	光通量	演色性	輸入電壓	發光角度	材質	壁切調色
LED-CE50DMR2-DW	樟木紋	3W   50W	3000K	21LM	≥ 80	100-240V (全電壓)	160°	鐵材烤白漆 PC 擴散罩 ABS 邊框 PC 防觸電罩	四段 IC 白光→ 黃光→ 自然光→ 小夜燈
LED-CE50DMR2-BK	黑木紋		6500K	4800LM					
LED-CE50DMR2-LW	梧桐木紋								





CCAO20LP1210T2  
國家通訊傳播委員會



黑木紋



梧桐木紋

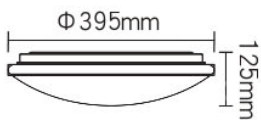

樟木紋

黑木紋

梧桐木紋

### 30W 和風調光雅緻吸頂燈



23,000

產品型號	燈體顏色	消耗電力	色溫	光通量	演色性	輸入電壓	發光角度	材質	壁切調色
LED-CE30DMR2-DW	樟木紋	1W   30W	3000K	3LM	≥ 80	100-240V (全電壓)	160°	鐵材烤白漆 PC 擴散罩 ABS 邊框 PC 防觸電罩	四段 IC 白光→ 黃光→ 自然光→ 小夜燈
LED-CE30DMR2-BK	黑木紋		6500K	2900LM					
LED-CE30DMR2-LW	梧桐木紋								

## 50W 和風星鑽吸頂燈



CCAO20LP1210T2  
國家通訊傳播委員會



樟木紋



6500K



3000K



4000K

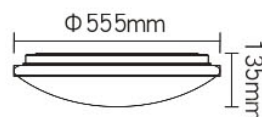

## 50W 和風調光星鑽吸頂燈



遙控



壁切

43,000

產品型號	燈體顏色	消耗電力	色溫	光通量	演色性	輸入電壓	發光角度	材質	壁切調色
LED-CES50DMR2DW	樟木紋	3W   50W	3000K	21LM	≥ 80	100-240V (全電壓)	160°	鐵材烤白漆 PMMA 擴散罩 ABS 邊框 PC 防觸電罩	四段 IC 白光→ 黃光→ 自然光→ 小夜燈
LED-CES50DMR2BK	黑木紋		6500K	4300LM					
LED-CES50DMR2LW	梧桐木紋								



## 30W 和風星鑽吸頂燈



CCAO20LP1210T2  
國家通訊傳播委員會



梧桐木紋



四段壁切



單色足瓦：  
每個色溫均達最高亮度，變色不變暗

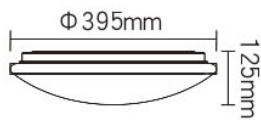

樟木紋

黑木紋

梧桐木紋

## 30W 和風調光星鑽吸頂燈



23,000

產品型號	燈體顏色	消耗電力	色溫	光通量	演色性	輸入電壓	發光角度	材質	壁切調色
LED-CES30DMR2DW	樟木紋	1W   30W	3000   6500K	2LM   2700LM	≥ 80	100-240V (全電壓)	160°	鐵材烤白漆 PMMA 擴散罩 ABS 邊框 PC 防觸電罩	四段 IC 白光→ 黃光→ 自然光→ 小夜燈
LED-CES30DMR2BK	黑木紋								
LED-CES30DMR2LW	梧桐木紋								



## 銀河系列



LED-CE30DMR2-WH

(時尚白)



LED-CE30DMR2-GY

(太空灰)



LED-CE30DMR2-GD

(香檳金)



LED-CE30DMR2-PK

(珊瑚橘)



30W 調光銀河吸頂燈



CCAO20LP1210T2  
國家通訊傳播委員會



雅緻柔和燈罩

自然光 4000K



白光 6500K



黃光 3000K



四段壁切



單色足瓦：

每個色溫均達最高亮度，變色不變暗

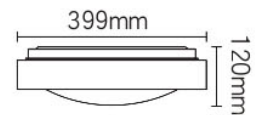

- ✓ 遙控
- ✓ 壁切

23,000

產品型號	燈體顏色	消耗電力	色溫	光通量	演色性	輸入電壓	發光角度	燈體材質	壁切調色溫
LED-CE30DMR2-WH	時尚白	1W   30W	3000K	2LM	≥ 80	100V   240V (全電壓)	160°	PC 擴散罩 鐵材烤白漆 PC 防觸電罩 ABS 邊框	四段 IC 白光→ 黃光→ 自然光→ 小夜燈
LED-CE30DMR2-GY	太空灰		6500K	2900LM					
LED-CE30DMR2-GD	香檳金								
LED-CE30DMR2-PK	珊瑚橘								



## 調光吸頂燈

單色  
足瓦

遠程遙控  
20M

四段  
壁切

調光調色  
28段

6500K



3000K



1. 首創：轉盤式操控更方便
2. 2.4GHz RF 高靈敏遙控器，可遙控最遠 20 米
3. 可 28 段調整明暗、色溫，讓生活豐富多彩

4. 四段壁切調光（白光 / 黃光 / 自然光 / 小夜燈）
5. 單色足瓦：每個色溫均達最高亮度，變色不變暗



## 75W 調光星鑽吸頂燈



CCAO20LP1210T2  
國家通訊傳播委員會



## [ 遙控器功能鍵說明 ]

## 電源鍵

長按：配對設定鍵  
短按：開/關燈

## 調光+/-

短按：亮度4段變化  
25%→50%→75%→100%  
長按：亮度28段變化

## 一鍵白光模式

6500K / 亮度100%

## 一鍵自然光模式

4000K / 亮度100%

## 調色+/-

短按：色溫4段變化  
3000K→4000K→5500K→6500K  
長按：色溫28段變化

## 轉盤

切換：單擊中間LOGO轉盤切換調光/調色  
調整：順時針亮度/色溫增大  
逆時針亮度/色溫減小

## 一鍵小夜燈模式

切換此模式不能調光/調色

## 一鍵黃光模式

3000K / 亮度100%



快速安裝結構



多媒體說明



均光滿板晶片無暗區



✓ 遙控

✓ 壁切

52,000

產品型號	消耗電力	色溫	光通量	演色性	輸入電壓	發光角度	材質	壁切調色
LED-CES75DMR2	3 W   75W	3000K   6500K	21LM   7000LM	≥ 80	100-240V (全電壓)	160°	PMMA 星鑽燈罩 烤漆鐵底盤 PC 防觸電罩	四段調色 白光→黃光→ 自然光→小夜燈

## 50W 調光星鑽吸頂燈



CCAO20LP1210T2  
國家通訊傳播委員會



## 單色足瓦：

每個色溫均可達最高亮度，  
變色不變暗



四段壁切

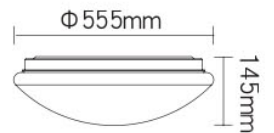

快速安裝結構

✓ 遙控

✓ 壁切

35,000

產品型號	消耗電力	色溫	光通量	演色性	輸入電壓	發光角度	燈體材質	壁切調色溫
LED-CES50DMR2	3W   50W	3000K   6500K	21LM   5200LM	≥ 80	100V   240V (全電壓)	160°	PMMA 星鑽燈罩 烤漆鐵底盤 PC 防觸電罩	四段調色 白光→黃光→ 自然光→小夜燈



## 30W 調光星鑽吸頂燈



CCAO20LP1210T2  
國家通訊傳播委員會



無藍光  
危害

調光  
調色

適用  
4~5 坪

單色  
足瓦



## 單色足瓦：

每個色溫均可達最高亮度，  
變色不變暗



四段壁切

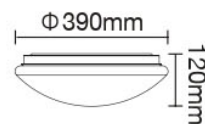

快速安裝結構

✓ 遙控

✓ 壁切

18,500

產品型號	消耗電力	色溫	光通量	演色性	輸入電壓	發光角度	燈體材質	壁切調色溫
LED-CES30DMR2	1W   30W	3000K   6500K	3LM   2900LM	≥ 80	100V   240V (全電壓)	160°	PMMA 星鑽燈罩 烤漆鐵底盤 PC 防觸電罩	四段調色 白光→黃光→ 自然光→小夜燈

## 50W 四段壁切調光星鑽吸頂燈



1. 4 段壁切調光
2. 100%-50%-25%- 小夜燈
3. 可依不同照明需求調整亮度
4. 快速安裝



四段壁切

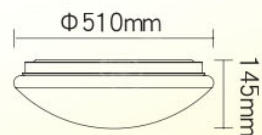

100% 亮度 (5000LM)



50% 亮度 (2600LM)



25% 亮 (1400LM)

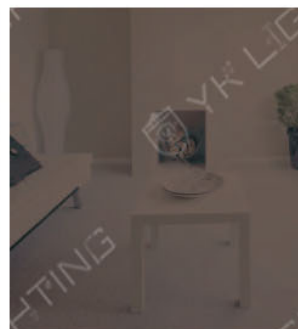

小夜燈 (3LM)

✓ 壁切

22,000

產品型號	消耗電力	色溫	光通量	演色性	輸入電壓	發光角度	燈體材質
LED-CES50DSW	50W	6500K	5000LM	≥ 80	100V   240V (全電壓)	160°	PMMA 星鑽燈罩 鐵材烤白漆
LED-CES50WSW	50W	3000K	4500LM				



## LED 單色星鑽吸頂燈



1. 全系列共 3 個瓦數，有 12、16、30W
2. 星鑽燈罩柔和不眩光
3. 燈板防觸電設計，絕緣安全
4. 內附快速接頭，安裝便利

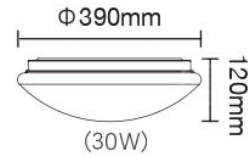
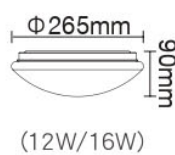

12W **3,000** 16W **3,500** 30W **9,500**

產品型號	消耗電力	色溫	光通量	演色性	輸入電壓	發光角度	燈體材質
LED-CES12DR2	12W	6500K	950LM	≥ 80	100V-240V (全電壓)	160°	PMMA 星鑽燈罩 烤漆鐵底盤 PC 防觸電罩
LED-CES12WR2	12W	3000K	850LM				
LED-CES16DR2	16W	6500K	1150LM				
LED-CES16WR2	16W	3000K	1050LM				
LED-CES30DR1	30W	6500K	2800LM				
LED-CES30WR1	30W	3000K	2700LM				

## LED 單色雅緻吸頂燈

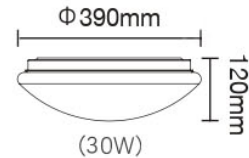
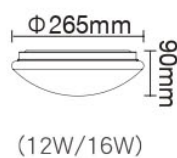

1. 全系列共 3 個瓦數，有 12、16、30W
2. 雅緻燈罩高雅不眩光
3. 燈板防觸電設計，絕緣安全
4. 內附快速接頭，安裝便利

12W **3,000**16W **3,500**30W **9,500**

產品型號	消耗電力	色溫	光通量	演色性	輸入電壓	發光角度	材質
LED-CE12DR2	12W	6500K	1000LM	≥ 80	100V-240V (全電壓)	160°	MS 雅緻燈罩 烤漆鐵底盤 PC 防觸電罩
LED-CE12WR2	12W	3000K	900LM				
LED-CE16DR2	16W	6500K	1200LM				
LED-CE16WR2	16W	3000K	1100LM				
LED-CE30DR1	30W	6500K	2900LM				
LED-CE30WR1	30W	3000K	2800LM				



## LED 單色菱鑽吸頂燈



1. 全系列共 2 個瓦數，有 12、16W
2. 菱鑽燈罩高雅不眩光
3. 燈板防觸電設計，絕緣安全
4. 內附快速接頭，安裝便利

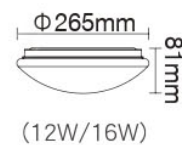

(12W/16W)

12W **3,500** 16W **4,000**

產品型號	消耗電力	色溫	光通量	演色性	輸入電壓	發光角度	材質
LED-CED12DR2	12W	6500K	950LM	≥ 80	100-240V (全電壓)	160°	PMMA 菱鑽燈罩 烤漆鐵底盤 PC 防觸電罩
LED-CED12WR2	12W	3000K	850LM				
LED-CED16DR2	16W	6500K	1150LM				
LED-CED16WR2	16W	3000K	1050LM				

## LED 玻璃蛋糕吸頂燈



時尚白

古典木

質感銀

1. 全電壓設計方便安裝
2. 一體式燈板設計柔和均光
3. 適用於樓梯間、玄關、陽台



5,000

產品型號	燈體顏色	消耗電力	色溫	光通量	演色性	輸入電壓	發光角度	材質
LED-CEK16D-WHR1	時尚白	16W	6500K	1250LM	≥ 80	100-240V (全電壓)	130°	白玉玻璃 烤漆鐵底盤
LED-CEK16W-WHR1	時尚白	16W	3000K	1200LM				
LED-CEK16D-SR1	質感銀	16W	6500K	1250LM				
LED-CEK16W-SR1	質感銀	16W	3000K	1200LM				
LED-CEK16D-CWR1	古典木	16W	6500K	1250LM				
LED-CEK16W-CWR1	古典木	16W	3000K	1200LM				

## 大小珠薄型吸頂燈 < 2022 Q2 上市 >



1. 薄型吸頂燈厚度僅有 3.5 公分
2. 均勻發光無暗區
3. 快速接頭方便安裝
4. 獨創固定扣安裝方式

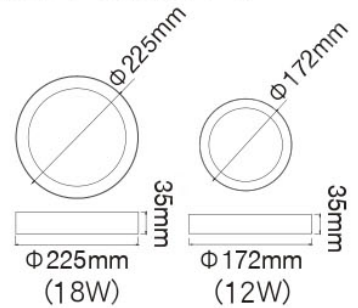

18W **5,000**    12W **4,000**

## 白大珠 / 小珠吸頂燈

產品型號	燈體顏色	消耗電力	色溫	光通量	演色性	輸入電壓	發光角度	材質
LED-21029DR1	時尚白	18W	6000K	1700LM	≥ 80	100-240V (全電壓)	160°	PC 塑料
LED-21029NR1		18W	4000K	1700LM				
LED-21029WR1		18W	3000K	1650LM				
LED-21028DR1		12W	6000K	1140LM				
LED-21028NR1		12W	4000K	1140LM				
LED-21028WR1		12W	3000K	1100LM				



獨創固定扣安裝

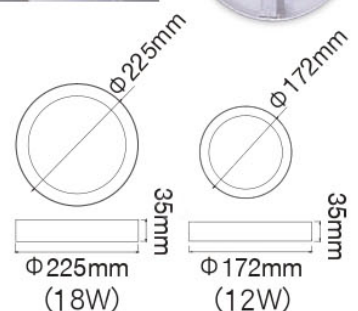

18W **5,000**    12W **4,000**

## 黑大珠 / 小珠吸頂燈

產品型號	燈體顏色	消耗電力	色溫	光通量	演色性	輸入電壓	發光角度	材質
LED-21029DR1-BK	貴族黑	18W	6000K	1700LM	≥ 80	100-240V (全電壓)	160°	PC 塑料
LED-21029NR1-BK		18W	4000K	1700LM				
LED-21029WR1-BK		18W	3000K	1650LM				
LED-21028DR1-BK		12W	6000K	1140LM				
LED-21028NR1-BK		12W	4000K	1140LM				
LED-21028WR1-BK		12W	3000K	1100LM				



## LED 微波感應戶外吸頂燈



CCAO21LP011BT5  
國家通訊傳播委員會

OD-CE16DSER1



CCAO21LP011CT7  
國家通訊傳播委員會

OD-CE16WSER1



## 固定扣環

拆罩時防止各部件脫落

## 防眩 PC

燈罩抗 UV 不泛黃

## 高亮度

均光晶片

## 發泡式防水膠圈

比傳統密實性防水膠圈防水等級更好



## 防水、防蚊蟲外框

可杜絕大量進水

## 微波動感感應器

Sens: 最長感應距離 15 米

Lux: 可調整日夜模式

Time: 最長亮燈時間 12 分鐘



多媒體說明

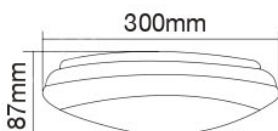

10,000

產品型號	消耗電力	色溫	光通量	演色性	輸入電壓	發光角度	燈體材質
OD-CE16DSER1	16W	6250K( 正白 )	1600LM	≥ 80	100V-240V ( 全電壓 )	140°	抗 UV PC
OD-CE16WSER1		3000K( 暖白 )	1500LM				

## LED 防水膠囊壁燈 / 吸頂燈

IP66



OD-WL10D 3,900



OD-CE16D 4,200

1. 一體成型輕巧好安裝
2. 採用防水驅動器
3. 抗 UV PC 材質不發黃
4. 鍍鎳壁板 / 不鏽鋼安裝螺絲抗腐鏽

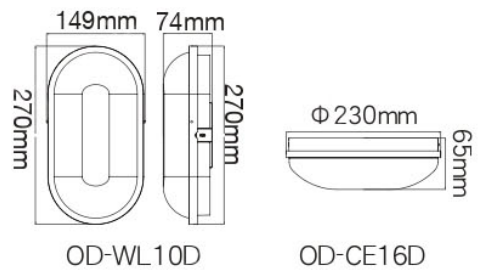

OD-WL10D

OD-CE16D

產品型號	安裝方式	消耗電力	色溫	光通量	演色性	輸入電壓	燈體材質
OD-WL10D	壁燈	10W	6500K	800LM	≥ 80	100-240V (全電壓)	抗 UV PC
OD-WL10W			3000K	720LM			
OD-CE16D	吸頂燈	16W	6500K	1600LM			
OD-CE16W			3000K	1440LM			

方型壁燈



珠盤壁燈

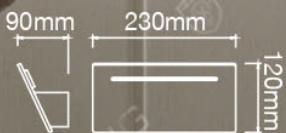

LED-26005



LED-26008

\* 限裝潢板

8,500

產品型號	燈體	消耗電力	色溫	光通量	演色性	輸入電壓	材質
LED-26005	方型	7W	3000K	480LM	$\geq 80$	100V-240V (全電壓)	白色壓鑄鋁烤漆 壓克力
LED-26008	珠盤						





8W  
全亮模式

3W  
重點閱讀光

5W  
環境光

1. 光束與背光環，重點照明和氣氛照明隨您調控
2. 可調式燈頭操控光線 如光隨行
3. 雙開關隨切隨換 隨心所欲

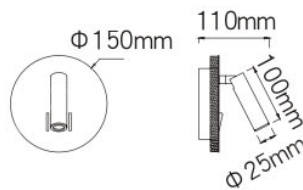

上下 90° / 左右 340°

12,000

產品型號	消耗電力	色溫	光通量	演色性	輸入電壓	材質
LED-26011	8W	3000K	487LM	≥ 80	100V-240V (全電壓)	白色鋁合金烤漆

## 蘭特床頭壁燈



1. 彎管造型，可隨心所欲調整角度
2. 光線柔和
3. 手動開關適用於房間或飯店床頭空間
4. 黑色 / 白色烤漆，兩種款式

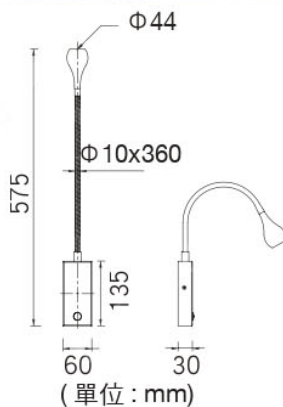

11,000

產品型號	燈體顏色	消耗電力	色溫	光通量	演色性	輸入電壓	材質
LED-26009	時尚白	3W	3000K	135LM	≥ 80	100V-240V (全電壓)	烤漆鋁合金
LED-26009-BK	貴族黑						

## 科夫床頭壁燈



1. 彎管造型，可隨心所欲調整角度
2. 光線柔和
3. 手動開關適用於房間或飯店床頭空間

\* 限裝潢板



11,000

產品型號	消耗電力	色溫	光通量	演色性	輸入電壓	材質
LED-26010-BK	3W	3000K	170LM	$\geq 80$	100V-240V (全電壓)	烤漆鋁合金



黑金箔雙燈

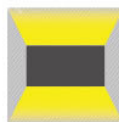
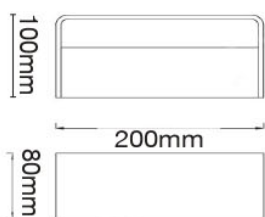

光型示意



1. 輕巧時尚設計更添時尚感
2. 內塗金漆使折射出的光線更佳耀眼動人

11,000

產品型號	消耗電力	色溫	光通量	演色性	輸入電壓	材質
LED-26001-BK	7W	3000K	350LM	≥ 80	100V-240V (全電壓)	烤漆壓鑄鋁 (外黑內金) 壓克力



## 黑金箔單燈

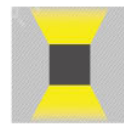
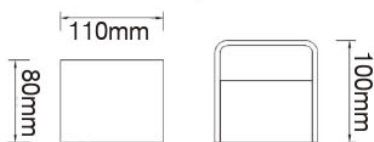

光型示意



1. 輕巧時尚設計更添時尚感
2. 內塗金漆使折射出的光線更佳耀眼動人

8,500

產品型號	消耗電力	色溫	光通量	演色性	輸入電壓	材質
LED-26002-BK	7W	3000K	250LM	$\geq 80$	100V-240V (全電壓)	烤漆壓鑄鋁 (外黑內金) 壓克力

## 金箔雙燈



1. 輕巧時尚設計更添時尚感
2. 內塗金漆使折射出的光線更佳耀眼動人

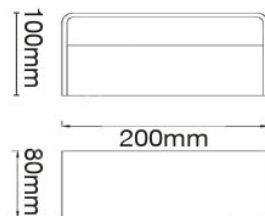

11,000

產品型號	消耗電力	色溫	光通量	演色性	輸入電壓	材質
LED-26001	7W	3000K	350LM	≥ 80	100V-240V (全電壓)	烤漆壓鑄鋁 (外白內金) 壓克力



## 金箔單燈



1. 輕巧時尚設計更添時尚感
2. 內塗金漆使折射出的光線更佳耀眼動人

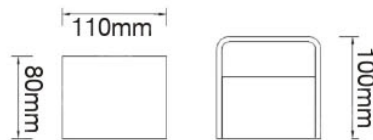

8,500

產品型號	消耗電力	色溫	光通量	演色性	輸入電壓	材質
LED-26002	7W	3000K	250LM	$\geq 80$	100V-240V (全電壓)	烤漆壓鑄鋁 (外白內金) 壓克力



# 海王星雙臂檯燈

新品

< 2022 Q1 上市 >

[休閒模式 3000K]



[工作模式 4000K]



[閱讀模式 6500K]



一鍵輕鬆調節明暗 / 冷暖

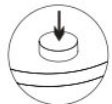

點擊按鈕  
開啟 / 關閉

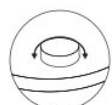

旋轉按鈕  
調節光線亮度



下壓並旋轉  
調節色溫冷暖



RA90 高演色性，還原真實色彩





RA90



多媒體說明

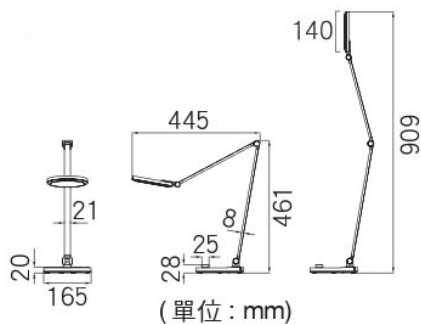

1. 簡約雙臂設計，可自由調整使用角度
2. 可調光調色，符合日常需求  
(休閒、工作、閱讀等多種模式)
3. RA90 高演色性，護眼健康

15,000

產品型號	燈體顏色	消耗電力	色溫	光通量	演色性	輸入電壓	發光角度	材質
LED-DLNE7	時尚白	7W	3000K   6500K	500LM	≥ 90	100V-240V (全電壓)	120°	ABS
LED-DLNE7-BK	貴族黑							

長頸鹿檯燈



可調式軟管



開關 / 調光 / 調色



小夜燈模式



元氣黃



夢幻粉

● 右邊R ON/OFF 開 (按 1 秒) / 關 (長按)  
三色溫切換 (白光 > 自然光 > 黃光)

● 左邊L 明暗調整 三檔亮度切換：高 > 中 > 低  
小夜燈打開 (長按) / 關 (長按)

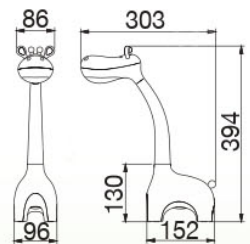

LED-DLGF6-Y  
(單位：mm)

9,000

產品型號	燈體顏色	消耗電力	色溫	光通量	輸入電壓	演色性	燈體材質
LED-DLGF6-P	夢幻粉	6W	三色溫切換 (白光 > 自然光 > 黃光)	點觸式調光最高 350LM、小夜燈	100V-240V (全電壓)	≥ 80	ABS
LED-DLGF6-Y	元氣黃						



天王星檯燈



時尚白



貴族黑



滑觸式調亮度



開 / 關



輕按即可變色溫  
三色溫切換 (白光 > 自然光 > 黃光)



2 段小夜燈

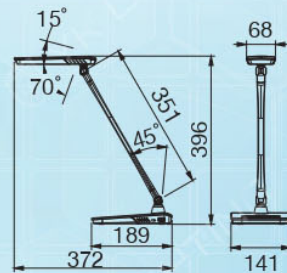

(單位: mm)



多媒體說明

9,000

產品型號	燈體顏色	消耗電力	色溫	光通量	輸入電壓	演色性	發光角度	燈體材質
LED-DLUR8	時尚白	8W	三色溫切換 (白光 > 自然光 > 黃光)	滑觸式調光最 高 420LM、 小夜燈	100V-240V (全電壓)	≥ 80	120°	ABS
LED-DLUR8-BK	貴族黑							

感應層板燈



紅外線感應

柔和均光

磁吸安裝



紅外線感應處  
感應距離 6cm



1. 適用於櫥櫃、床邊
2. 揮手即可感應點燈
3. 內附插頭，隨插即用



可磁吸安裝



手勢感應開關



內附 1.5M 插頭線

45公分 **5,200** 60公分 **6,000**

產品型號	消耗電力	色溫	光通量	演色性	輸入電壓	發光角度	材質
LED-45LA10WHS	10W	3000K	800LM	≥ 90	100-240V (全電壓)	110°	PC
LED-45LA10DHS	10W	6500K	800LM				
LED-60LA12WHS	12W	3000K	1000LM				
LED-60LA12DHS	12W	6500K	1000LM				



## 圓滿光感小夜燈



時尚白



櫻花粉



蘋果綠

1. 仿月環光型，光型溫和舒適
2. 插頭式通電設計，隨插即用
3. 光線不足時自動感測並點亮
4. 適用於臥室、出入口等居家空間
5. 一年耗電量 < 1 度電（每天 10 小時計）



產品型號	燈體顏色	消耗電力	色溫	光通量	演色性	輸入電壓	發光角度	材質
LED-NLA0.2W	時尚白	0.2W	2700K	6LM	≥ 80	110V	120°	PC
LED-NLA0.2W-PK	櫻花粉							
LED-NLA0.2W-GP	蘋果綠							

紫威殺菌燈

微波感應

適裝 7.5 坪



安全鎖設計  
避免孩童誤觸

30 mins

60 mins

兩檔定時可選



場域建議使用時間



廚房、浴室 30分鐘



客廳、臥室 60分鐘

通過國際 TAF 及台灣衛福部認可實驗

最高可有效消滅 99.97% 有害病菌

1. 30 秒蜂鳴延時啟動，提醒人員安全撤離
2. 微波感應距離 5 米，生物接近感應自動關閉

※ 非主照明，避免眼睛直視

※ 消滅病毒種類以測試報告為準

29,000



產品型號	消耗電力	輸入電壓	波長	材質
UVC33WR1	33W	100-240V (全電壓)	253nm	鋁合金烤漆



## 簡易型殺菌燈座



1 尺 10W 殺菌管  
飛利浦



2 尺 20W 殺菌管  
日本 SANKYO



3 尺 30W 殺菌管  
飛利浦



4 尺 40W 殺菌管  
飛利浦

1. 可抑制或消滅空氣中有害病毒、孢菌
2. 物體經消毒後，無損害，無汙染，無殘留
3. 內附安定器及 6 尺開關線



10W 用安定器



20-40W 安定器



6 尺開關線

※ 注意：眼睛不可直視紫外線燈管，避免灼傷

時價



產品型號	消耗電力	輸入電壓	安定器	波長	尺寸	固定方式	材質
UV-11441	10W	110V	低功安定器	253nm	387 x 57 x 83mm	吸頂式	冷軋鋼板
UV-21441	20W	100-240V (全電壓)	高功安定器		637 x 57 x 83mm		
UV-31441	30W				952 x 57 x 84mm		
UV-41441	40W				1256 x 57 x 84mm		



# 廠辦照明

## LED 柔光平板燈

>> 一體成型鋁邊框，  
堅固不漏光設計

>> PS 擴散板，  
降低眩光不刺眼

>> 快速接頭，施工便利

>> PET 反光紙提升  
整燈亮度

>> 二次光學晶片  
均光無暗區

1. 節能 / 比傳統輕鋼架省電 50%
2. 護眼 / 高透光 PS 擴散板均勻柔和低眩光
3. 品質 / 通過國家標準和光生物安全認證
4. 時尚 / 燈具簡約時尚好應用
5. 容易清潔、不光衰

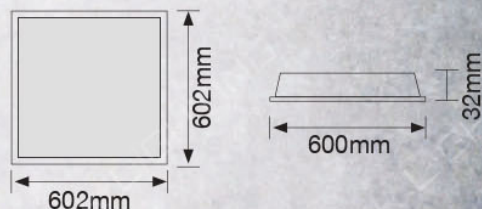



## 25W 雙節標柔光平板燈



節能標章  
發光二極體平板燈



節能標章  
辦公室節標

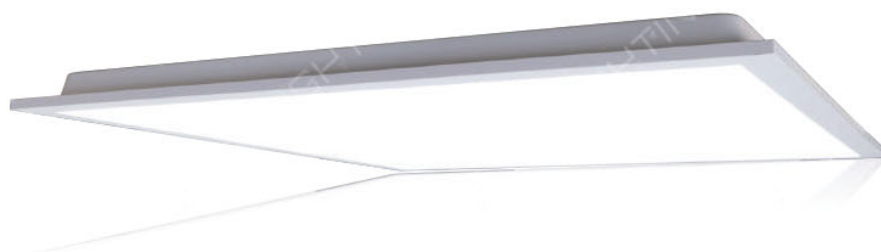

1. 超高光效 140LM/W
2. 高均勻度、均光不刺眼
3. 平均壽命可達 30000 小時



可改吊式 (LED-PD40-CN6)  
吊鍊包另計

10,000

產品型號	消耗電力	色溫	光通量	演色性	輸入電壓	發光角度	燈體材質	固定方式
LED-PD25DESR1	25W	6500K	3500LM	≥ 80	100V-240V (全電壓)	160°	鋁邊框、鐵底殼 PET 反射片 PS 高透光擴散板	嵌入式 吸頂式 吊鍊式 (吸頂框、 吊鍊包另計)

## 40W 柔光平板燈



可改吊式 (LED-PD40-CN6)  
吊鍊包另計

8,000

產品型號	消耗電力	色溫	光通量	演色性	輸入電壓	發光角度	燈體材質	固定方式
LED-PD40DR2	40W	6500K	4000LM	≥ 80	100V-240V (全電壓)	160°	鋁邊框、鐵底殼 PET 反射片 PS 高透光擴散板	嵌入式 吸頂式 吊鍊式 (吸頂框、 吊鍊包另計)
LED-PD40NR2		4000K	4000LM					
LED-PD40WR2		3000K	4000LM					

### 4 尺雙節標柔光平板燈



LED-42PD45DES



LED-41PD25DES

1. 通過發光二極體平板燈節能標章、辦公室節能標章
2. 高光效 145LM/W
3. 低頻閃、高均勻度
4. 平均壽命可達 30000 小時

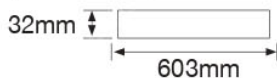

LED-42PD45DES



LED-41PD25DES



可改吊式，吊鍊包另計  
4x2:LED-42PD-CN6  
4x1:LED-PD40-CN6



4x2 尺 **30,000**    4x1 尺 **16,000**

產品型號	消耗電力	色溫	光通量	演色性	輸入電壓	發光角度	燈體材質	固定方式
LED-42PD45DES	45W	5700K	7000LM	≥ 80	100V-240V (全電壓)	160°	鋁邊框、鐵底殼 PET 反射片 PS 高透光擴散板	嵌入式
LED-41PD25DES	25W	5700K	3500LM					吸頂式 吊鍊式 (吸頂框、 吊鍊包另計)



## ▲ 平板燈吸頂框架



卡榫安裝，方便快捷

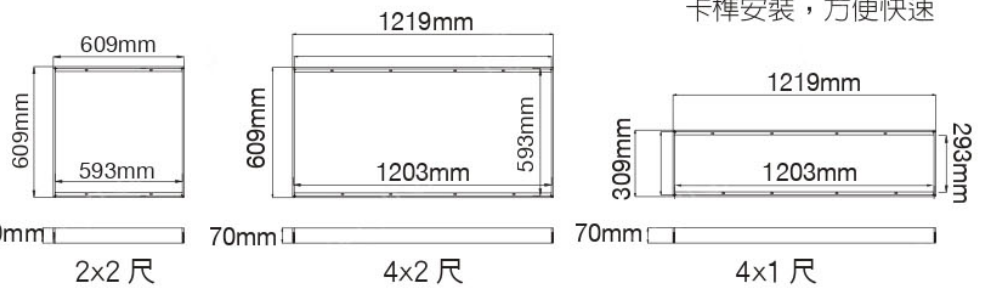

1. 鋁材邊框好輕巧

2. 簡易安裝好方便

產品型號	適用燈具	尺寸
LED-PD40-FR1	2x2 尺 LED 平板燈	L 609mm x W 609mm x H 70mm
LED-42PD-FR1	4x2 尺 LED 平板燈	L 1219mm x W 609mm x H 70mm
LED-41PD-FR1	4x1 尺 LED 平板燈	L 1219mm x W 309mm x H 70mm



# LED 超薄調光平板燈



亮度100%  
辦公模式

亮度50%  
簡報模式

亮度25%  
休憩模式

## 超薄背板

薄型冷軋鋼板 • 平滑好輕巧

## 珍珠棉

減緩外力擠壓 • 保護燈體

## 光學級反光紙

反射率>96% •  
有效提升光線均勻性

## PMMA導光板

光線均勻擴散，不發黃光板  
五道燈板二次光學，均勻護眼

## PS擴散板

高透光擴散板 • 柔和不刺眼

## LED燈條(側發光)

體積小 • 彈性佳  
不佔空間

## 鋁邊框

一體成型鋁邊框 • 堅固不漏光

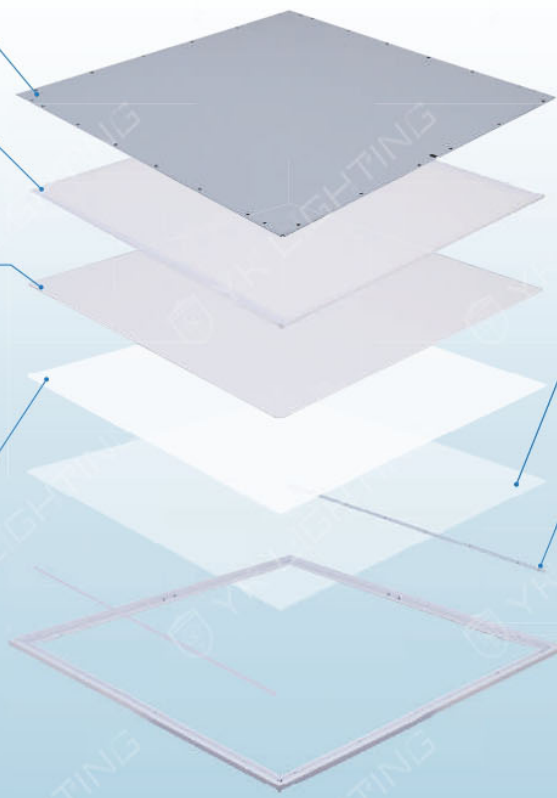



## 40W 壁切超薄調光平板燈



1. 燈體超薄設計，厚度僅 9mm
2. 三段壁切調光，可配合環境空間應用
3. 亮度切換順序：100% → 50% → 25%，  
關燈 60 秒後重置
4. 有三種安裝方式：嵌入式、吸頂式 (LED-PD40-FR1 吸頂框)  
吊鍊式 (LED-PA40R6-CN1 吊鍊包) 配件另購



三段壁切

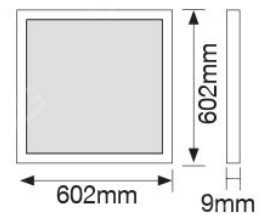

✓ 壁切

11,000

產品型號	消耗電力	色溫	光通量	演色性	輸入電壓	發光角度	燈體材質
LED-PA40DSW	40W	6500K	1000LM	≥ 80	100V-240V (全電壓)	110°	鋁邊框、PMMA 導光板、PS 擴散板 鐵背板
LED-PA40NSW	40W	4000K	4000LM				

## LED 替換式輕鋼架

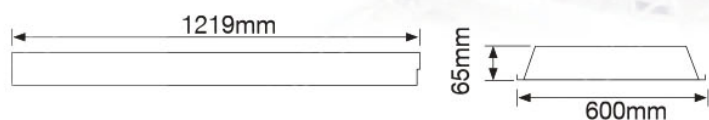

## 4 尺 x 2 尺三管輕鋼架

時價

產品型號	適用光源	發光角度	燈體材質	固定方式
LED-4341R6	LED T8 4 尺燈管 X3 另計	160°	冷軋鋼板、12 片高反射格柵	吸嵌二用



## 4 尺 x 1 尺二管輕鋼架

時價

產品型號	適用光源	發光角度	燈體材質	固定方式
LED-4241R6	LED T8 4 尺燈管 X2 另計	160°	冷軋鋼板、12 片高反射格柵	吸嵌二用





### 2 尺 x 2 尺四管輕鋼架

時價

產品型號	適用光源	發光角度	燈體材質	固定方式
LED-2441R1	LED T8 2 尺燈管 X4 另計	160°	冷軋鋼板、6 片高反射格柵	吸嵌二用

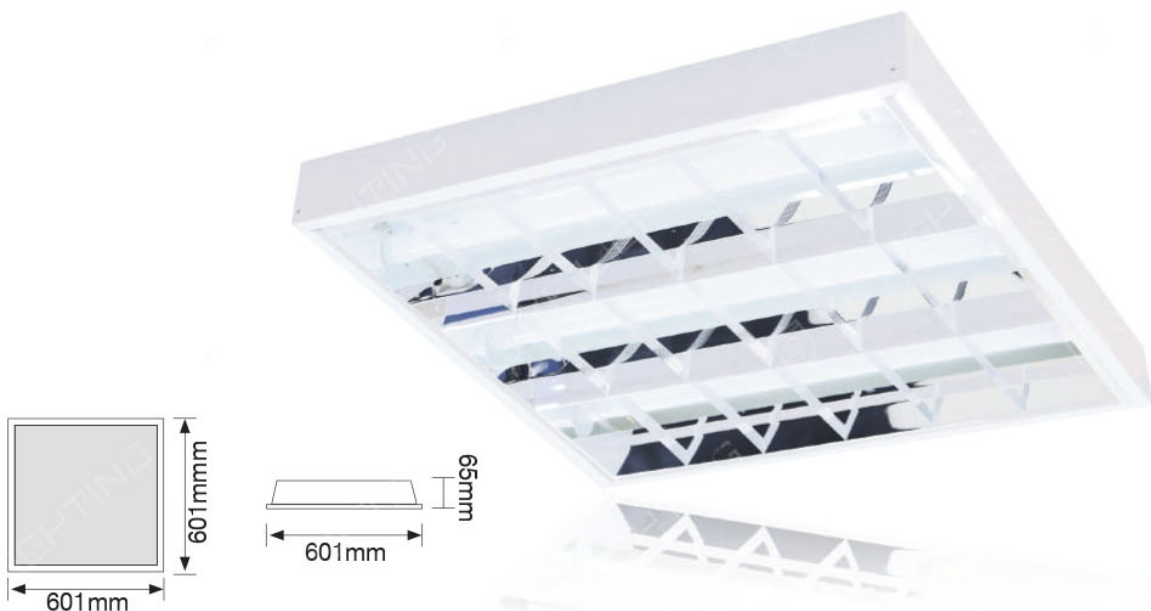

### 2 尺 x 2 尺三管輕鋼架

時價

產品型號	適用光源	發光角度	燈體材質	固定方式
LED-2341R6	LED T8 2 尺燈管 X3 另計	160°	冷軋鋼板、5 片高反射格柵	吸嵌二用

亞特防眩節能吊燈



光型示意

1. 一體成型時尚美觀
2. 吊線 1.5 米可調整長度
3. 防眩罩不刺眼
4. 垂吊燈具讓光線集中工作面
5. 採用最適工作色溫 4000k 自然光，溫和不疲勞

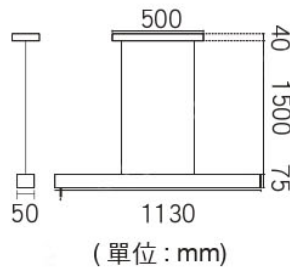

LED-29023N-BK



LED-29023N-SV

16,500

產品型號	消耗電力	色溫	光通量	燈體顏色	演色性	輸入電壓	發光角度	材質
LED-29023N-BK	30W	4000K	2500LM	貴族黑	≥ 80	100-240V (全電壓)	110°	鋁材 PC 燈罩
LED-29023N-SV	30W	4000K	2500LM	質感銀				



## LED 燈管替換型燈具



LED-4124 20,000



LED-4125 20,000

1. 鋁合金材質質感佳
2. 防眩燈罩不刺眼
3. 適用於辦公室、居家
4. 吊線 1 米可調整長度



光型示意

產品型號	燈體顏色	適用光源	材質	尺寸
LED-4124	貴族黑	LED T8 4 尺燈管 x1 另計	鋁合金、壓克力燈罩	L1250mm x D70mm x H80mm
LED-4125	質感銀			

## LED 燈管替換型燈具



LED-4278 49,000



LED-4178 40,000

1. 木紋簡約時尚
2. 燈管內藏不眩光
3. 適用 LED T8 燈管
4. 吊線 1 米可調整長度



光型示意

產品型號	適用光源	材質	尺寸
LED-4278	LED T8 4 尺燈管 X2 另計	梧桐木烤平光漆 鐵材烤黑漆	L1300mm x W160mm x H100mm
LED-4178	LED T8 4 尺燈管 X1 另計		L1300mm x W88mm x H100mm

## LED 燈管替換型燈具



LED-4132 49,000

新品

LED-4181 53,000 (可改吸頂式)

LED-4220 54,000 (可改吸頂式)

1. 原木材質耐用性佳
2. 燈管內藏不眩光
3. 適用 LED T8 燈管
4. 吊線 1 米可調整長度

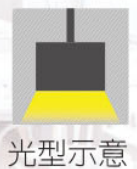

光型示意

產品型號	適用光源	材質	尺寸
LED-4132	LED T8 4 尺燈管 x1 另計	胡桃木貼皮、 鐵材烤黑漆	L1265mm x D60mm x H100mm
LED-4181	LED T8 4 尺燈管 x1 另計	實心橡木、 鐵材烤黑漆、壓克力罩	L1245mm x D69mm x H91mm
LED-4220	LED T8 4 尺燈管 x2 另計		L1265mm x D150mm x H100mm



## LED 燈管替換型燈具



LED-4227 20,000



LED-4228 20,000

1. 鋁合金材質質感佳
2. 防眩燈罩不刺眼
3. 適用於辦公室、居家
4. 吊線 1 米可調整長度



光型示意

產品型號	燈體顏色	適用光源	材質	尺寸
LED-4227	貴族黑	LED T8 4 尺燈管 x2 另計	鋁合金、壓克力燈罩	L1250mm x D250mm x H60mm
LED-4228	質感銀			

## LED 燈管替換型燈具



LED-4234 28,000



LED-4237 28,000

1. 鋁合金材質質感佳
2. 防眩設計不刺眼
3. 適用於辦公室、居家
4. 吊線 1 米可調整長度



光型示意

產品型號	燈體顏色	適用光源	材質	尺寸
LED-4234	質感銀	LED T8 4 尺燈管 X2 另計	鋁合金烤銀漆 鐵材電鍍鉻色 鋁格柵	L1260mm x W124mm x H60mm
LED-4237	貴族黑	LED T8 4 尺燈管 X2 另計	鋁合金烤黑漆 鐵材電鍍鉻色 鋁格柵	

## LED 燈管替換型燈具



LED-4282-SV 25,000



LED-4282-BK 25,000

1. 鋁合金材質質感佳
2. 防眩燈罩不刺眼
3. 適用於辦公室、居家
4. 吊線 1 米可調整長度



光型示意

產品型號	燈體顏色	適用光源	材質	尺寸
LED-4282-SV	質感銀	LED T8 4 尺燈管 x2 另計	鋁合金 壓克力燈罩	L1242mm x D100mm x H55mm
LED-4282-BK	貴族黑			



## LED 燈管替換型燈具

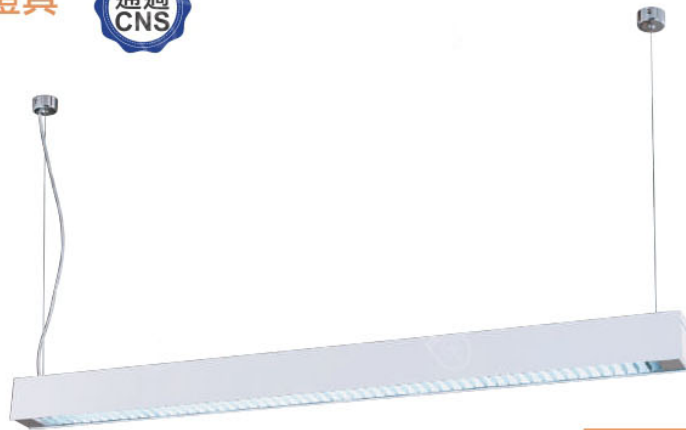

LED-4183 24,000



LED-4183-SV 24,000



LED-4183-BK 24,000

1. 鋁合金材質質感佳
2. 防眩設計不刺眼
3. 適用於辦公室、居家
4. 吊線 1 米可調長度



光型示意

產品型號	燈體顏色	適用光源	材質	尺寸
LED-4183	時尚白	LED T8 4 尺燈管 X1 另計	鋁合金 鋁格柵	L1250mm x W70mm x H80mm
LED-4183-SV	質感銀	LED T8 4 尺燈管 X1 另計		
LED-4183-BK	貴族黑	LED T8 4 尺燈管 X1 另計		

## LED 燈管替換型燈具



LED-4184 33,000



LED-4184-BK 33,000

1. 鋁合金材質質感佳
2. 防眩設計不刺眼
3. 適用於辦公室、居家
4. 吊線 1 米可調整長度



光型示意

產品型號	燈體顏色	適用光源	材質	尺寸
LED-4184	時尚白	LED T8 4 尺燈管 x1 另計	木質烤平光漆 山毛櫸	L1327mm x D70mm x H80mm
LED-4184-BK	貴族黑			

## LED 燈管替換型吊桿式燈具

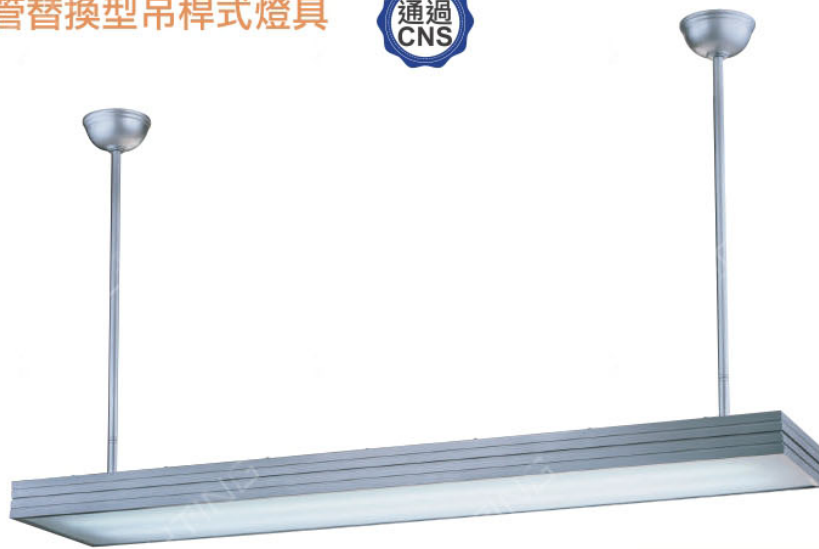

LED-4285-SV

25,000



LED-4285-BK

25,000

1. 鋁合金材質質感佳
2. 防眩燈罩不刺眼
3. 適用於辦公室、居家
4. 吊桿長度為 800mm



新品



光型示意

產品型號	燈體顏色	適用光源	材質	尺寸
LED-4285-SV	質感銀	LED T8 4 尺燈管 X2 另計	鋁合金 壓克力罩	L1250mm x W250mm x H910mm
LED-4285-BK	貴族黑	LED T8 4 尺燈管 X2 另計		



## LED 燈管替換型吊桿式燈具



LED-4286-SV 33,000

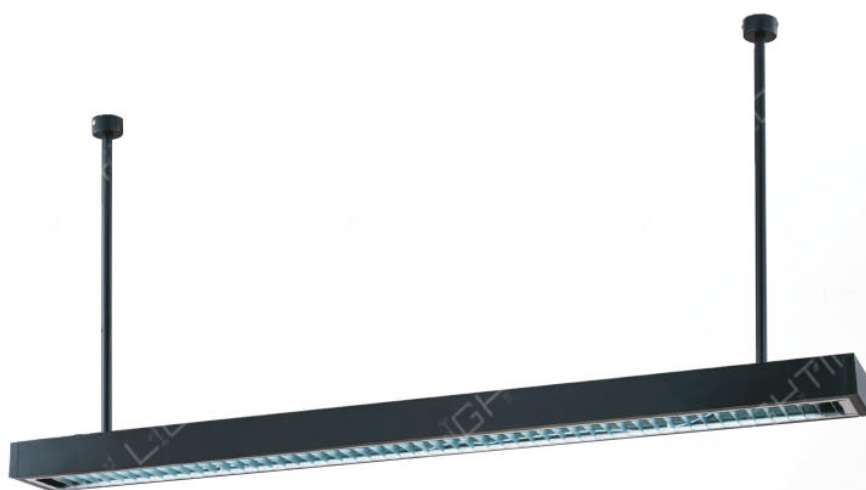

LED-4286-BK 33,000

1. 鋁合金材質質感佳
2. 防眩設計不刺眼
3. 適用於辦公室、居家
4. 吊桿長度為 500mm(另可訂製 800mm)



光型示意

產品型號	燈體顏色	適用光源	材質	尺寸
LED-4286-SV	質感銀	LED T8 4 尺燈管 X2 另計	鋁合金 鋁格柵	L1260mm x W126mm x H595mm
LED-4286-BK	貴族黑	LED T8 4 尺燈管 X2 另計		

## LED 燈管替換型半吸式燈具



LED-4187 27,000



LED-4187-SV 27,000



LED-4187-BK 27,000

1. 鋁合金材質質感佳
2. 防眩設計不刺眼
3. 適用於辦公室、居家
4. 半吸式，吊桿長 80mm



新品

※ 可訂製霧面燈罩款式



光型示意

產品型號	燈體顏色	適用光源	材質	尺寸
LED-4187	時尚白	LED T8 4 尺燈管 X1 另計	鋁合金 鋁格柵	L1250mm x W70mm x H190mm
LED-4187-SV	質感銀	LED T8 4 尺燈管 X1 另計		
LED-4187-BK	貴族黑	LED T8 4 尺燈管 X1 另計		

# LED 晨光吸頂燈



節能標章  
辦公室節標  
(4尺、2尺)



- 1. 一體成型時尚美觀
- 2. 防眩罩不刺眼

- 3. 高亮度、高光效 120LM/W
- 4. 不斷光側蓋





透明側蓋串接不斷光



高亮度滿版晶片



壁板快裝結構設計



壁板可加裝吊管(吊管另計)

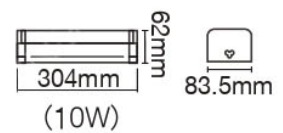
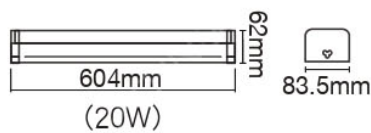
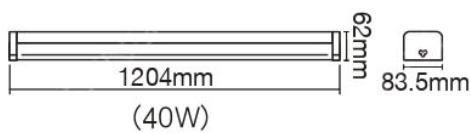

產品型號	消耗電力	色溫	光通量	演色性	輸入電壓	發光角度	燈體材質
LED-4216D	40W	6500K	4800LM	≥ 80	100V-240V (全電壓)	300°	鋁底盤 PC罩 304不鏽鋼壁板 吊吸兩用
LED-2216D	20W	6500K	2400LM				
LED-1216D	10W	6500K	1200LM				

T5 壁切三色支架燈  
< 2022 Q2 上市 >



6500K (白光)

3000K (黃光)

4000K (自然光)

1. 適裝於天花板
2. 隨應用情境輕鬆切換三色溫
3. 串接不斷光
4. 各尺寸可串接 6 組

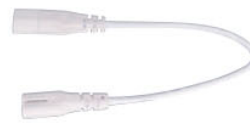

串接線另計  
LED-T5BA-PCDR2



三段壁切  
(白光→黃光→自然光)



1 尺 **2,000**    2 尺 **3,000**    4 尺 **4,000**

產品型號	消耗電力	壁切色溫	光通量	尺寸	演色性	輸入電壓	發光角度	燈體材質
LED-T5BAC-1SW	5W	6500K   3000K   4000K	450LM( 白光 ) 400LM( 黃光 ) 450LM( 自然光 )	W:300mm D:26mm H:37mm	≥ 80	100-240V ( 全電壓 )	210°	散熱塑
LED-T5BAC-2SW	9W		900LM( 白光 ) 850LM( 黃光 ) 900LM( 自然光 )	W:600mm D:26mm H:37mm				
LED-T5BAC-4SW	18W		1800LM( 白光 ) 1620LM( 黃光 ) 1800LM( 自然光 )	W:1182mm D:26mm H:37mm				



## T5 一體式開關支架燈

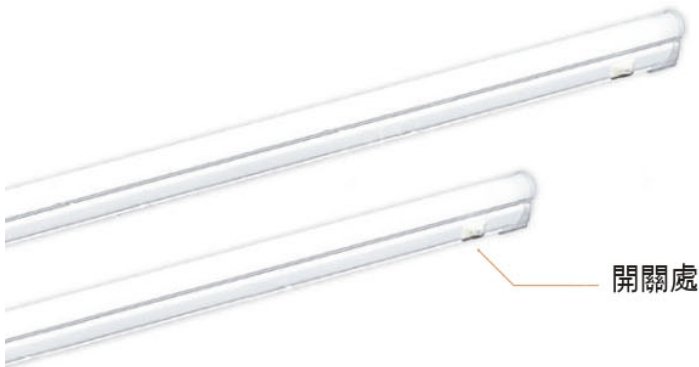

開關處

1. 適裝於流理台
2. 串接不斷光
3. 可隨心控制單支開關
4. 各尺寸可串接 6 組
5. 內附插頭線



單支附開關

串接線另計  
LED-T5BA-PCDR21 尺 **2,000** 2 尺 **3,000** 4 尺 **4,000**

產品型號	消耗電力	色溫	光通量	尺寸	演色性	輸入電壓	發光角度	燈體材質
LED-T5BA1DSW	5W	6500K	400LM	W:300mm D:26mm H:37mm	≥ 80	100-240V (全電壓)	210°	散熱塑
LED-T5BA1NSW	5W	4000K	400LM					
LED-T5BA1WSW	5W	3000K	360LM					
LED-T5BA2DSW	9W	6500K	900LM	W:600mm D:26mm H:37mm				
LED-T5BA2NSW	9W	4000K	900LM					
LED-T5BA2WSW	9W	3000K	850LM					
LED-T5BA4DSW	18W	6500K	1800LM	W:1182mm D:26mm H:37mm				
LED-T5BA4NSW	18W	4000K	1800LM					
LED-T5BA4WSW	18W	3000K	1620LM					



## T5 一體式支架燈



1. 一體成型適合裝於天花板
2. 與傳統 T5 相比省電近 40%
3. 全電壓安裝方便
4. 公母插串接不斷光
5. 各尺寸可串接 6 組



R8 版串接線 (LED-T5BA-PCDR2) 另計  
R7 版串接線內附

時價

產品型號	消耗電力	色溫	光通量	尺寸	演色性	輸入電壓	發光角度	燈體材質
LED-T5BA1-DR8	5W	6500K	400LM	W:300mm D:26mm H:37mm	≥ 80	100-240V (全電壓)	210°	散熱塑
LED-T5BA1-NR8	5W	4000K	400LM					
LED-T5BA1-WR8	5W	3000K	360LM					
LED-T5BA2-DR8	9W	6500K	900LM	W:600mm D:26mm H:37mm				
LED-T5BA2-NR8	9W	4000K	900LM					
LED-T5BA2-WR8	9W	3000K	850LM					
LED-T5BA3-DR8	14W	6500K	1200LM	W:900mm D:26mm H:37mm				
LED-T5BA3-NR8	14W	4000K	1200LM					
LED-T5BA3-WR8	14W	3000K	1100LM					
LED-T5BA4-DR8	18W	6500K	1800LM	W:1182mm D:26mm H:37mm				
LED-T5BA4-NR8	18W	4000K	1800LM					
LED-T5BA4-WR8	18W	3000K	1620LM					

T5 燈管 LED 專用燈具 (無安定器)



< 2022 Q3 上市 >



時價

產品型號	適用光源	燈體材質	尺寸
LED-4243-T5	LED-T5 4 尺燈管 x2 另計 (LED T5 驅動內藏型燈管)	冷軋鋼板 白色粉體烤漆	L:1180mm W:137mm H:45mm
LED-4143-T5	LED-T5 4 尺燈管 x1 另計 (LED T5 驅動內藏型燈管)		L:1192mm W:137mm H:65mm
LED-2243-T5	LED-T5 2 尺燈管 x2 另計 (LED T5 驅動內藏型燈管)		L:595mm W:137mm H:45mm
LED-2143-T5	LED-T5 2 尺燈管 x1 另計 (LED T5 驅動內藏型燈管)		L:590mm W:137mm H:65mm
LED-2441-T5	LED-T5 2 尺燈管 x4 另計 (LED T5 驅動內藏型燈管)		L:600mm W:600mm H:45mm



LED-4201R2+IC (4 尺) 5,500

LED-2201R2+IC (2 尺) 4,200



LED-4202R2+IC (4 尺) 5,500

LED-2202R2+IC (2 尺) 4,200

### LED 燈管型燈具

產品型號	適用光源	尺寸	發光角度	燈體材質
LED-4201R2+IC	LED T8 4 尺 X2 另計 (內附 E12 2Wx1+IC,110V)	L: 1345mm D: 215mm H: 80mm	290°	銀塑膠飾邊、飾蓋、鐵板
LED-2201R2+IC	LED T8 2 尺 X2 另計 (內附 E12 2Wx1+IC,110V)	L: 710mm D: 215mm H: 80mm		
LED-4202R2+IC	LED T8 4 尺 X2 另計 (內附 E12 2Wx1+IC,110V)	L: 1345mm D: 215mm H: 80mm		黑胡桃塑膠飾邊、飾蓋、鐵板
LED-2202R2+IC	LED T8 2 尺 X2 另計 (內附 E12 2Wx1+IC,110V)	L: 710mm D: 215mm H: 80mm		





6,800

產品型號	適用光源	燈體材質	尺寸
LED-4203	LED T8 4 尺燈管 X2 另計 (內附 E12 2W X1+IC,110V)	鋼板烤漆、塑料核木	L:1330mm D: 175mm H:70mm



6,200

產品型號	適用光源	燈體材質	尺寸
LED-4103	LED T8 4 尺燈管 X1 另計	鋼板烤漆、塑料核木	L: 1330mm D: 175mm H: 70mm



6,500

產品型號	適用光源	燈體材質	尺寸
LED-4204	LED T8 4 尺燈管 X2 另計 (內附 E12 2W X1+IC,110V)	鋼板烤漆、塑料銀灰	L: 1330mm D: 175mm H: 70mm

6,500



產品型號	適用光源	燈體材質	尺寸
LED-2203	LED T8 2 尺燈管 X2 另計 (內附 E12 2W X1+IC,110V)	鋼板烤漆 塑料核木	L: 710mm D: 175mm H: 70mm

6,200



產品型號	適用光源	燈體材質	尺寸
LED-2204	LED T8 2 尺燈管 X2 另計 (內附 E12 2W X1+IC,110V)	鋼板烤漆 塑料銀灰	L: 710mm D: 175mm H: 70mm

雙管山型燈



LED-4243R5



LED-2243R5

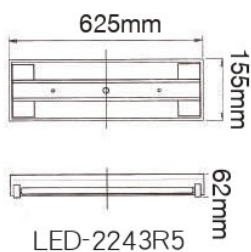
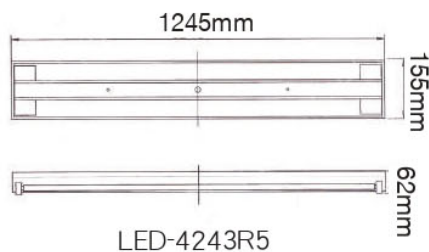

專利設計防脫落螺絲

產品型號	適用光源	發光角度	燈體材質
LED-4243R5	LED T8 4 尺燈管 X2 另計	300°	冷軋鋼板 不脫落固定螺絲
LED-42430MR1	LED T8 4 尺燈管 X2 另計， 內附小夜燈 5WX1+IC, 110V		
LED-2243R5	LED T8 2 尺燈管 X2 另計		
LED-22430MR1	LED T8 2 尺燈管 X2 另計， 內附小夜燈 5WX1+IC, 110V		

## 單管山型燈



※ 新型專利 M564122 號

1. 底部加厚不變型
2. 防脫落螺絲設計

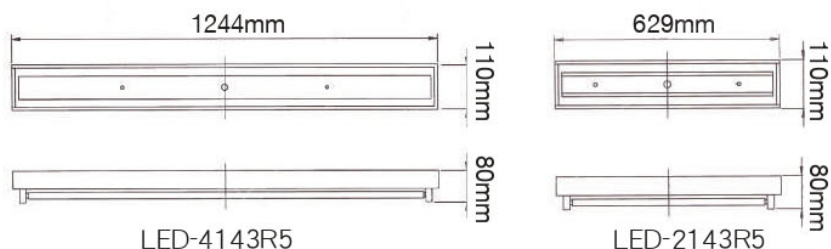

產品型號	適用光源	發光角度	燈體材質
LED-4143R5	LED T8 4 尺燈管 X1 另計	290°	冷軋鋼板 不脫落固定螺絲
LED-41430MR1	LED T8 4 尺燈管 X1 另計 內附小夜燈 5WX1+IC, 110V		
LED-2143R5	LED T8 2 尺燈管 X1 另計		
LED-21430MR1	LED T8 2 尺燈管 X1 另計 內附小夜燈 5WX1+IC, 110V		
LED-1143R3	LED T8 1 尺燈管 X1 另計		



工事燈



LED-4240 (鐵烤漆)



LED-4140 (鐵烤漆)



LED-42401R6 (鋁反射)



LED-41401R6 (鋁反射)

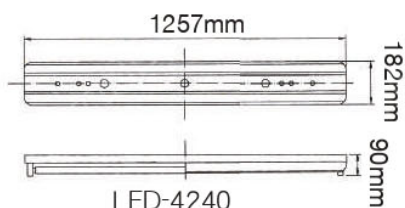

LED-4240



LED-4140

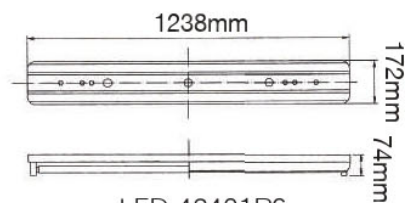

LED-42401R6



LED-41401R6



鋁罩燈體局部特寫

產品型號	適用光源	發光角度	反射罩	燈體材質	固定方式
LED-4240	LED T8 4 尺燈管 x2 另計	200°	鐵烤漆	冷軋鋼板	吊、吸兩用 (吊管另計)
LED-4140	LED T8 4 尺燈管 x1 另計	220°			
LED-42401R6	LED T8 4 尺燈管 x2 另計	200°	鋁反射		
LED-41401R6	LED T8 4 尺燈管 x1 另計	220°			

教室燈



燈體可轉角度

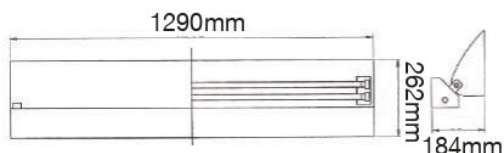

4 尺雙管黑板燈

產品型號	適用光源	發光角度	燈體材質	固定方式
LED-4257	LED T8 4 尺燈管 X2 另計	170°	冷軋鋼板	吊、吸二用 (吊管另計)



燈體可轉角度

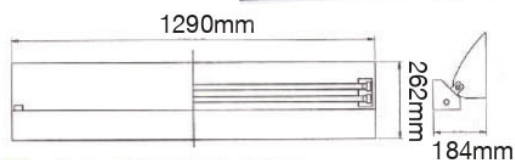

4 尺單管黑板燈

產品型號	適用光源	發光角度	燈體材質	固定方式
LED-4157	LED T8 4 尺燈管 X1 另計	170°	冷軋鋼板	吊、吸二用 (吊管另計)

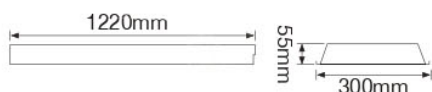

附吊管架 x2

4 尺雙管教室燈 ※ 整組燈具鏡面設計

產品型號	適用光源	發光角度	燈體材質	固定方式
LED-4267	LED T8 4 尺燈管 X2 另計	160°	冷軋鋼板、11 片高反射格柵	吊式 (吊管另計)



### 中東燈

時價

產品型號	適用光源	尺寸	燈體材質	發光角度
LED-41441	LED T8 4 尺燈管 X1 另計	L: 1256mm W: 57mm H: 84mm	冷軋鋼板	290°
LED-31441	LED T8 3 尺燈管 X1 另計	L: 952mm W: 57mm H: 84mm		
LED-21441	LED T8 2 尺燈管 X1 另計	L: 637mm W: 57mm H: 84mm		
LED-11441	LED T8 1 尺燈管 X1 另計	L: 387mm W: 57mm H: 83mm		



支架燈可串接 6 組

### T8 替換型支架燈

時價

產品型號	適用光源	尺寸	燈體材質	發光角度
LED-T8BA4-1R1	LED T8 4 尺燈管 X1 另計	L: 1223mm W: 30.3mm H: 44mm	鐵材 烤漆	290°
LED-T8BA3-1R1	LED T8 3 尺燈管 X1 另計	L: 926mm W: 30.3mm H: 44mm		
LED-T8BA2-1R1	LED T8 2 尺燈管 X1 另計	L: 604mm W: 30.3mm H: 44mm		
LED-T8BA1-1R1	LED T8 1 尺燈管 X1 另計	L: 363mm W: 30.3mm H: 44mm		



## 替換式加蓋燈具



1 尺 T8 加蓋燈具

1,500

產品型號	LED-1102R2
適用光源	LED T8 1 尺燈管 X1 另計
燈體材質	鐵材、PC 罩
尺 寸	L: 400mm D: 110mm H: 80mm



2 尺 T8 加蓋燈具

3,000

產品型號	LED-2105R1
適用光源	LED T8 2 尺燈管 X1 另計
燈體材質	鐵材、PC 罩
尺 寸	L: 655mm D: 140mm H: 95mm



1 尺 T8 加蓋燈具 (防眩)

1,500

產品型號	LED-1103
適用光源	LED T8 1 尺燈管 X1 另計
燈體材質	鐵材、防眩 PC 罩
尺 寸	L: 400mm D: 107mm H: 98mm



2 尺 T8 不鏽鋼加蓋燈具

3,000

產品型號	LED-2106
適用光源	LED T8 2 尺燈管 X1 另計
燈體材質	430 不鏽鋼、PC 罩
尺 寸	L: 635mm D: 110mm H: 90mm



1 尺 T8 不鏽鋼加蓋燈具 (防眩)

1,900

產品型號	LED-1103ST
適用光源	LED T8 1 尺燈管 X1 另計
燈體材質	304 不鏽鋼、防眩 PC 罩
尺 寸	L: 400mm D: 107mm H: 98mm



E27 不鏽鋼加蓋燈具

1,700

產品型號	LED-1104
適用光源	LED E27 球泡 另計
燈體材質	430 不鏽鋼、PC 罩
尺 寸	L: 300mm D: 110mm H: 95mm

# 戰神天井燈



< 2022 Q2 上市 >

>> 內附口鐵可吸頂固定

>> 崧盛 IP 防水  
耐高溫天井燈專用驅動器

>> 1 米防墜落安全繩

>> 高散熱  
壓鑄鋁本體



>> 三星高亮度晶片

>> 特殊 PC 蓋設計  
可加裝感應 超省電

1. 通過 60 度長期高溫測試，適合台灣炎熱氣候
2. 採用防水驅動器，一體成形增強防水性，輸入電壓可達 240V
3. 通過 CNS 認證，發光效率 120LM/W
4. 100W 適裝 6 米；150W 適裝 7 米；200W 適裝 8 米
5. 可另購微波感應器改裝為感應天井燈
6. 內附口鐵支架、可吸頂式安裝

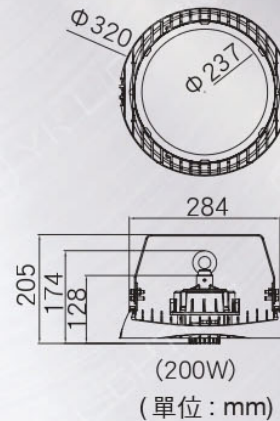
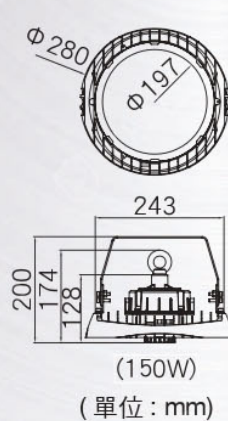
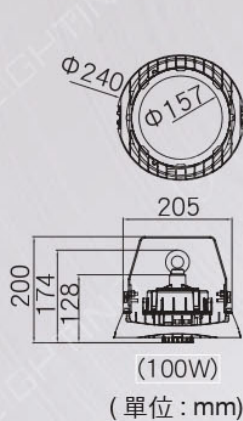
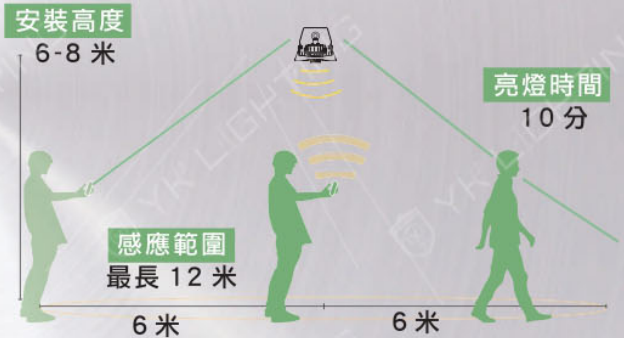



聚光鋁罩 (另計)

發光角度 90°

LED-HBCS100CN7 **5,000**

LED-HBCS150CN7 **5,000**

LED-HBCS200CN7 **6,000**

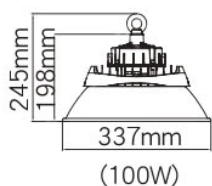

(100W)

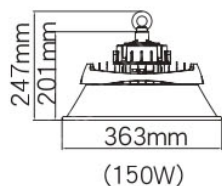

(150W)

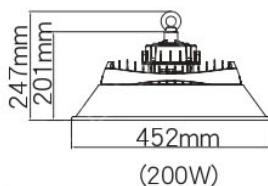

(200W)

產品配件 (內附)

可搭配件 (另計)



壁板掛勾

材質為鐵質鍍鋅  
最大承受：20kg



防墜繩

產品內附防墜繩  
最大承重：40kg



全天型微波感應器 (另計) **6,000**

LED-HBCS-CN3

1. 感應器距離最長 12 米
2. 亮燈時間 10 分鐘
3. 人經過就會亮
4. 安裝高度 6-8 米
5. 100-200W 通用
6. 內建感應參數不可調



戰神天井燈

LED-HBCS100D **43,000**

LED-HBCS150D **47,000**

LED-HBCS200D **50,000**

產品型號	消耗電力	色溫	光通量	演色性	重量	輸入電壓	發光角度	燈體材質
LED-HBCS100D	100W	5700K	12000LM	≥ 80	2.26kg (含口鐵)	100V-240V (全電壓)	110°	壓鑄鋁 強化玻璃 PC 蓋 深灰色粉體 防鏽烤漆
LED-HBCS150D	150W		18000LM		2.75kg (含口鐵)			
LED-HBCS200D	200W		24000LM		3.34kg (含口鐵)			



# 雙節標飛碟天井燈



節能標章  
天井燈節能標章



節能標章  
辦公室節標



>> 防墜落安全繩

>> 明緯 IP65 防水  
天井燈專用驅動器

>> 高散熱  
壓鑄鋁本體

>> 飛利浦高亮度晶片  
發光效率 140LM/W

>> 抗 UV PC 罩不變黃

## 節標證書 / BSMI 證書

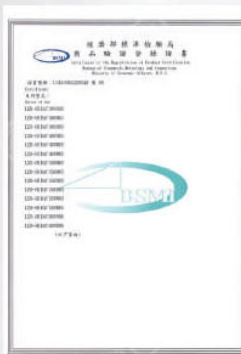

1. 通過長期高溫 60°C 測試，針對台灣炎熱氣候設計
2. 採用明緯天井燈專用驅動器，一體成型防水更好，輸入電壓可達 240V
3. 內附口鐵支架，可吸頂式安裝
4. 附上防墜吊繩，地震搖晃更安全
5. 100W 適用 6 米，150W 適用 7 米

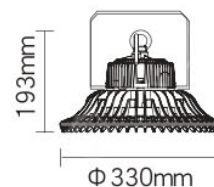
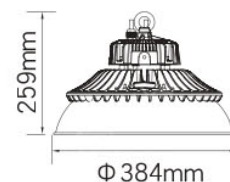

吊鍊安裝

聚光鋁罩 **5,000**(發光角度 90°)  
LED-HIBAY100CN7LED-HIBAY100DR5  
LED-HIBAY150DR5

## 產品配件 (內附)



掛勾壁板

材質為鐵質鍍鋅  
最大承重：20kg

防墜繩

產品內附防墜繩  
最大承重：40kg

## 可搭配配件 (另計)

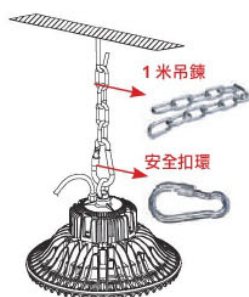
吊鍊吊掛式 **2,000**(1米吊鍊 + 安全扣環)  
LED-HIBAY100CN4

## 飛碟天井燈

LED-HIBAY100DR5 **55,000**LED-HIBAY150DR5 **65,000**

產品型號	消耗電力	色溫	光通量	演色性	重量	輸入電壓	發光角度	燈體材質
LED-HIBAY100DR5	100W	6250K	14000LM	≥ 80	3.88kg (含口鐵)	100V-240V (全電壓)	120°	壓鑄鋁 PC 深灰色粉體 防鏽烤漆
LED-HIBAY150DR5	150W	6250K	21000LM	≥ 80	4.28kg (含口鐵)			



# 飛碟天井燈



>> 明緯 IP65 防水耐高溫天井燈專用驅動器

>> 防墜落安全繩

>> 不鏽鋼 304 螺絲，防鏽蝕

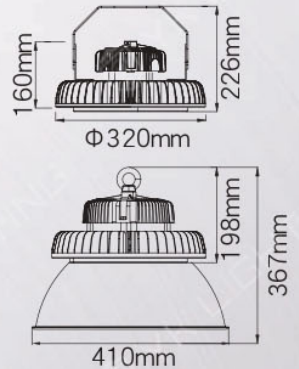

>> 驅動器架高設計，增強空氣對流，散熱更好

>> 高散熱 壓鑄鋁本體

>> 高透光強化玻璃不變黃

>> 飛利浦高亮度晶片 最高光效

## 產品配件 (內附)



掛勾壁板

材質為鐵質鍍鋅  
最大承重：20kg



防墜繩

產品內附防墜繩  
最大承重：40kg

## 可搭配件 (另計)



聚光鋁罩 **5,000**

LED-HIBAY200CN6  
(發光角度 90°)

1. 通過環溫 60°C 測試，特別適合台灣炎熱氣候
2. 採用明緯天井燈專用驅動器，一體成型防水更好，輸入電壓可達 240V
3. 可吸頂、吊掛
4. 每組附上防墜吊繩，地震搖晃更安全
5. 適用高度 10 米高以上

## 飛碟天井燈

LED-HIBAY200DR6 **70,000**

產品型號	消耗電力	色溫	光通量	演色性	重量	輸入電壓	發光角度	燈體材質
LED-HIBAY200DR6	200W	6250K	26000LM	≥ 80	6.35kg (含吊鐵)	100V-240V (全電壓)	120°	壓鑄鋁 強化玻璃 深灰色粉體 防鏽烤漆



# 旋風天井燈

IP66

最高耐壓  
277V

## 產品配件 (內附)



掛勾壁板

材質為鐵質鍍鋅  
最大承重：20kg



防墜繩

產品內附防墜繩  
最大承重：40kg

## 可搭配件 (另計)



聚光鋁罩 5,000

LED-HBWD100CN7  
(發光角度 90°)

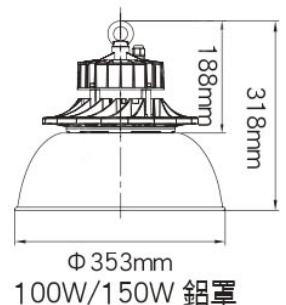
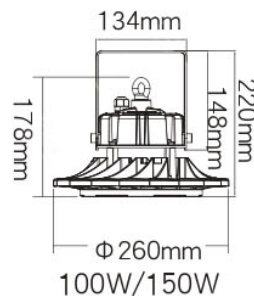

## 旋風天井燈

LED-HBWD100D 43,000

LED-HBWD150D 47,000

產品型號	消耗電力	色溫	光通量	演色性	重量	輸入電壓	發光角度	燈體材質
LED-HBWD100D	100W	6500K	11500LM	≥ 80	2.1kg (含口鐵)	100V-277V (全電壓)	120°	壓鑄鋁 強化玻璃 深灰色粉體 防鏽烤漆
LED-HBWD150D	150W	6500K	17250LM		2.6kg (含口鐵)			

# 泛光燈各高度距離 & 適裝建議





# 適裝：戶外廣告招牌、廣場、工廠

7 米	8 米	9 米	10 米	11 米
-----	-----	-----	------	------



150W



< 亞瑟 / 阿波羅 >

200W



< 阿波羅 >

300W



< 阿波羅 >

400W



< 阿波羅 >



多媒體說明

※ 以上適裝建議僅供參考，詳細亮度數據可參考 P.245-P.262 照度表



# 戶外燈具系列

亞瑟泛光燈



>> 發泡式膠圈，  
杜絕水氣



>> 100LM/W  
高光效 SMD 晶片



>> 呼吸器，有效阻水  
(100W/150W)



>> 3mm 以上厚支架  
抗強風不折彎



>> 防水堵線，有效防水



>> 耐壓 240V  
防水驅動器  
防突波 10kv

OD-FLS150DR1 36,000

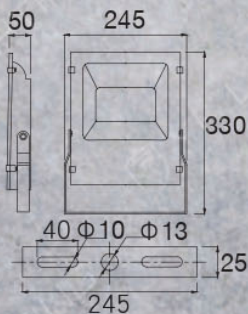

50W (單位: mm)

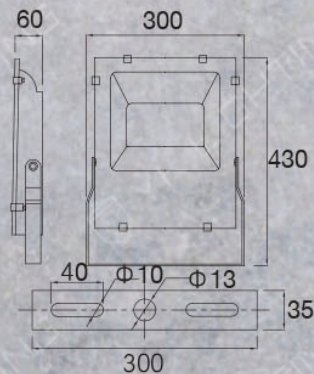

100W (單位: mm)

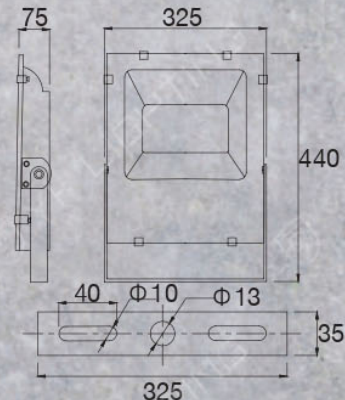

150W (單位: mm)



OD-FLS50DR1 12,500



OD-FLS100DR1 24,000

1. 可安裝於 -40°C 低溫環境
2. 高規格設計，通過 CNS 認證
3. 燈體及 304 螺絲抗鹽霧，通過鹽霧測試
4. 滿版玻璃高質感，強化玻璃不易破碎

\* 安裝請接地避免燈具遭突波損壞

\* 接線處須使用防水絕緣膠帶

### 亞瑟泛光燈

產品型號	消耗電力	色溫	光通量	演色性	輸入電壓	發光角度	燈體材質
OD-FLS50DR1	50W	6500K	5000LM	≥ 80	100-240V (全電壓)	140°	壓鑄鋁 強化玻璃 深灰色粉體 防鏽烤漆
OD-FLS50WR1		3000K	4500LM				
OD-FLS100DR1	100W	6500K	10000LM				
OD-FLS100WR1		3000K	9000LM				
OD-FLS150DR1	150W	6500K	15000LM				
OD-FLS150WR1		3000K	13500LM				



# 宙斯泛光燈

IP66

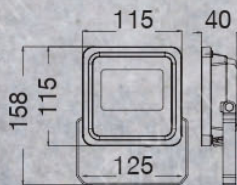

10W  
(單位：mm)

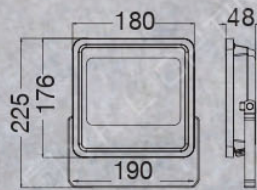

20/30W  
(單位：mm)

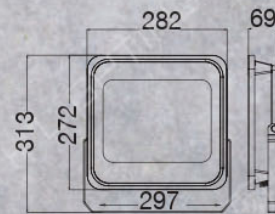

50W  
(單位：mm)





OD-FLZ10D

3,200



OD-FLZ20D

5,200



OD-FLZ30D

7,200



OD-FLZ50D

11,000

1. 可安裝於 -10°C 低溫環境
2. 10-30W 可改插地式 (插地棒 OD-3174-CN1 另計)

- \* 安裝請接地避免燈具遭突波損壞
- \* 接線處須使用防水絕緣膠帶

### 宙斯泛光燈

產品型號	電池消耗	色溫	光通量	演色性	輸入電壓	驅動器	發光角度	材質
OD-FLZ10D	10W	6500K	1000LM	≥ 80	100-240V (全電壓)	防水驅動器	140°	壓鑄鋁 強化玻璃 深灰色粉體 防鏽烤漆
OD-FLZ10W		3000K	900LM					
OD-FLZ20D	20W	6500K	2000LM					
OD-FLZ20W		3000K	1800LM					
OD-FLZ30D	30W	6500K	3000LM					
OD-FLZ30W		3000K	2700LM					
OD-FLZ50D	50W	6500K	5000LM		100-277V (全電壓)			
OD-FLZ50W		3000K	4500LM					

# 阿波羅單電壓泛光燈

IP66



>> 超薄壓鑄鋁殼體，  
全面積熱鰭鱗片

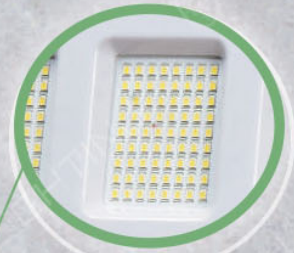

>> 100LM/W  
高光效 SMD 晶片



>> 發泡式膠圈，  
有效防水



>> 4mm 厚鐵支架抗  
強風不折彎 (400W)

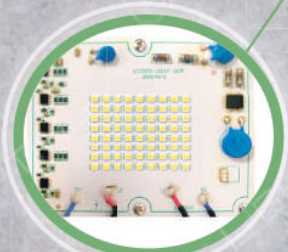

>> 大功率泛光燈專用電路設計



>> 防水堵線，有效防水

OD-FLDB400D/2

65,000

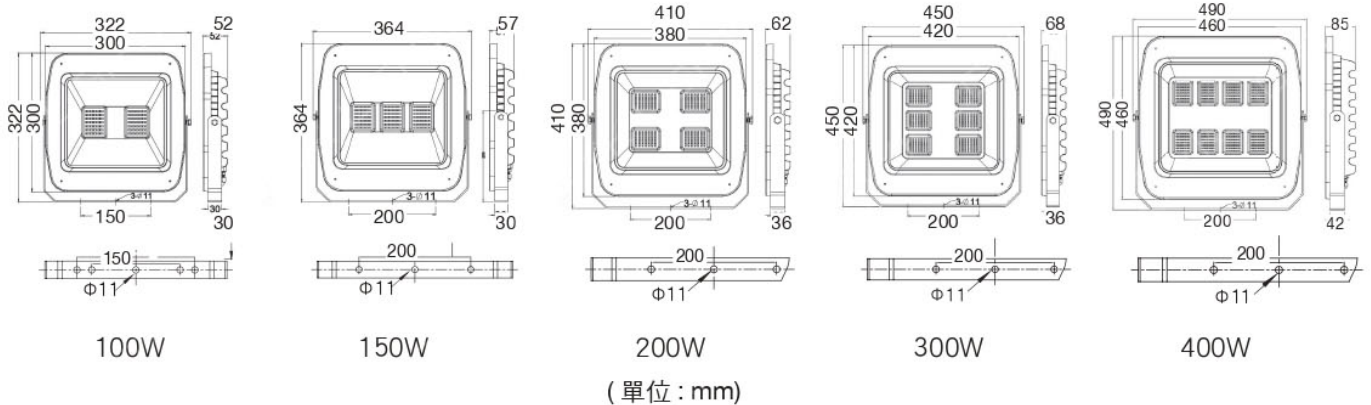





多媒體說明



OD-FLDB100D/2 16,000



OD-FLDB150D/2 28,000



OD-FLDB200D/2 37,000



OD-FLDB300D/2 50,000

1. 可安裝於  $-25^{\circ}\text{C}$  低溫環境
2. 若現場無做接地線系統，建議加裝繼電器

\* 安裝請接地避免燈具遭突波損壞

\* 接線處須使用防水絕緣膠帶

### 阿波羅單電壓泛光燈

產品型號	消耗電力	色溫	光通量	演色性	輸入電壓	發光角度	燈體材質
OD-FLDB100D/2	100W	5700K	10000LM	$\geq 70$	200-240V (單電壓)	150°	壓鑄鋁 強化玻璃 深灰色粉體 防鏽烤漆
OD-FLDB150D/2	150W		15000LM				
OD-FLDB200D/2	200W		20000LM				
OD-FLDB300D/2	300W		30000LM				
OD-FLDB400D/2	400W		40000LM				





# 智慧防水微波感應燈



## 安裝高度

2-4 米

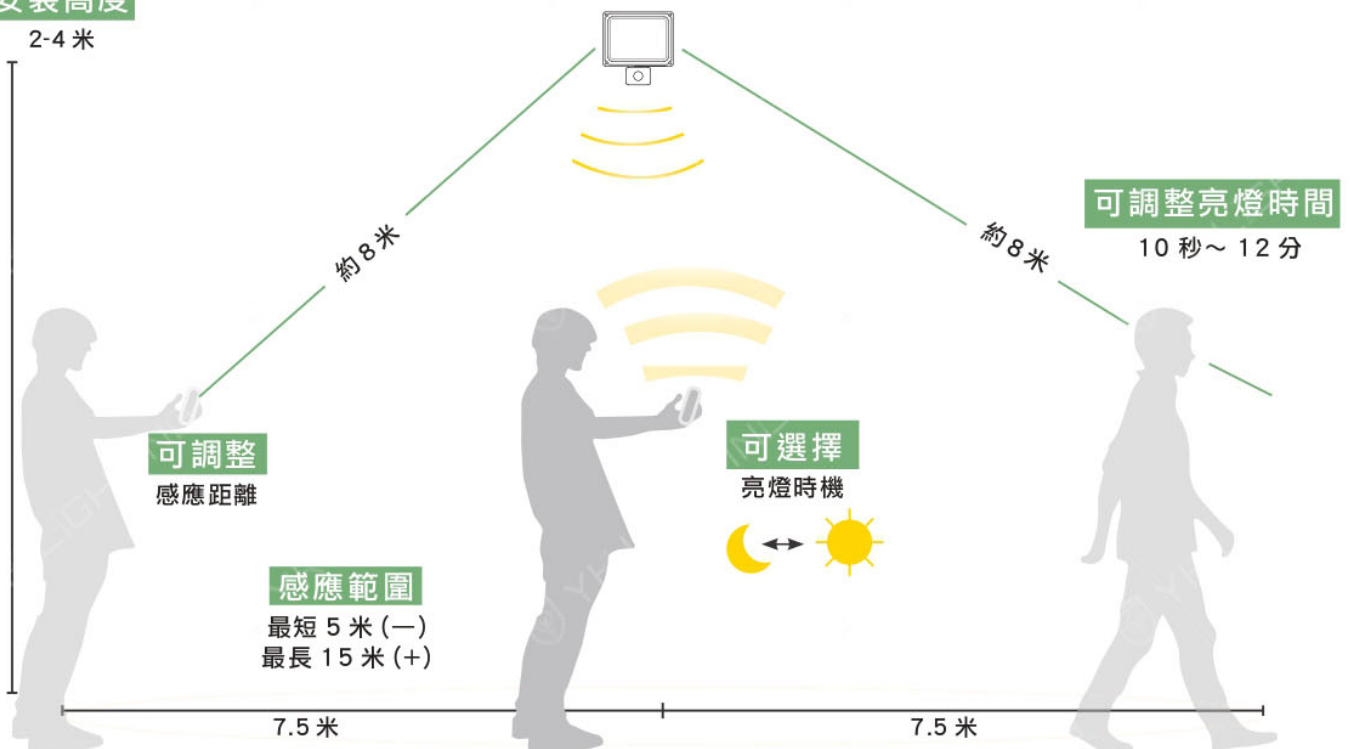

感應孔擴大  
光感效果更佳



採用超音波殼體結合  
防水效果更佳



## 中文旋鈕說明 清晰易懂

感應時間 - 等同於亮燈時間  
靈敏度 - 可調整感應距離，越往「+」距離越長  
日夜模式 - 環境光感自動亮燈（數值越小 = 環境越暗才亮燈；太陽 = 24hr 感應）

## 微波動感感應

Microwave Sensor，利用偵測物體移動的頻率感應雷達微波感應距離更遠，角度廣，無死角，能穿透玻璃、水泥和木板，根據功率不同可穿透不同厚度的牆壁，且不受環境、溫度、灰塵影響，在台灣長年高溫 37 度 C 下感應功能也不受影響

※ 注意：下雨時若雨滴移動啟動感應，可調整靈敏度以符合需求

CCAO21LP0700T9  
國家通訊傳播委員會  
OD-SEFL20D

CCAO21LP070AT1  
國家通訊傳播委員會  
OD-SEFL20W

CCAO21LP070BT0  
國家通訊傳播委員會  
OD-SEFL30D

CCAO21LP070CT2  
國家通訊傳播委員會  
OD-SEFL30W

IP66

微波  
感應



OD-SEFL20D 9,000



OD-SEFL30D 12,000

1. 採用微波感應，感應靈敏防水佳
2. 無需斷電即可調整
3. 感應啟動超省電

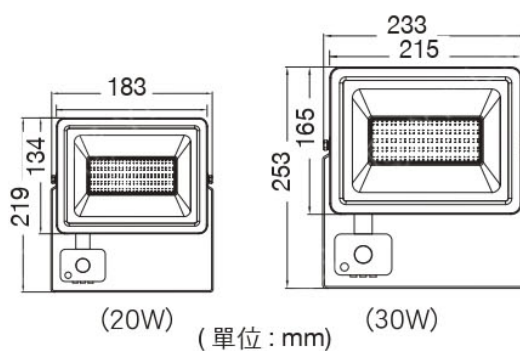

## LED 防水微波感應燈

產品型號	消耗電力	色溫	光通量	演色性	輸入電壓	驅動器	發光角度	燈體材質
OD-SEFL20D	20W	6500K	2000LM	≥ 80	100-240V (全電壓)	防水驅動器 (內含)	140°	壓鑄鋁 強化玻璃 深灰色粉體 防鏽烤漆
OD-SEFL20W		3000K	1800LM					
OD-SEFL30D	30W	6500K	3000LM					
OD-SEFL30W		3000K	2700LM					



LED 100W 銀榕路燈

IP66

適用  
4米



OD-10072R3

50,000

CL-01A

8,000

A 管另計

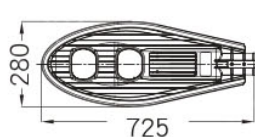

產品型號	消耗電力	色溫	光通量	演色性	輸入電壓	驅動器	發光角度	燈體材質
OD-10072R3	100W	6500K	13000LM	$\geq 80$	100V-277V (全電壓)	防水驅動器 (內含)	140°	壓鑄鋁 強化玻璃 深灰色



LED 50W 銀榕路燈

IP66

適用  
3米



※ 大面積鰭鱗散熱，良好光維持率



※120LM/W 高亮度



OD-10075R3

34,000

CL-01A

8,000

A 管另計

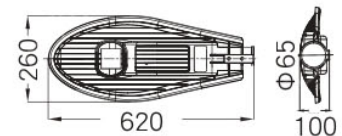
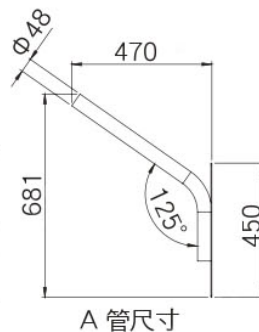

產品型號	消耗電力	色溫	光通量	演色性	輸入電壓	驅動器	發光角度	燈體材質
OD-10075R3	50W	6500K	6200LM	≥ 80	100V-277V (全電壓)	防水驅動器 (內含)	140°	壓鑄鋁 強化玻璃 深灰色
OD-10075WR3		3000K	5800LM					



# 大樓鷹眼線燈

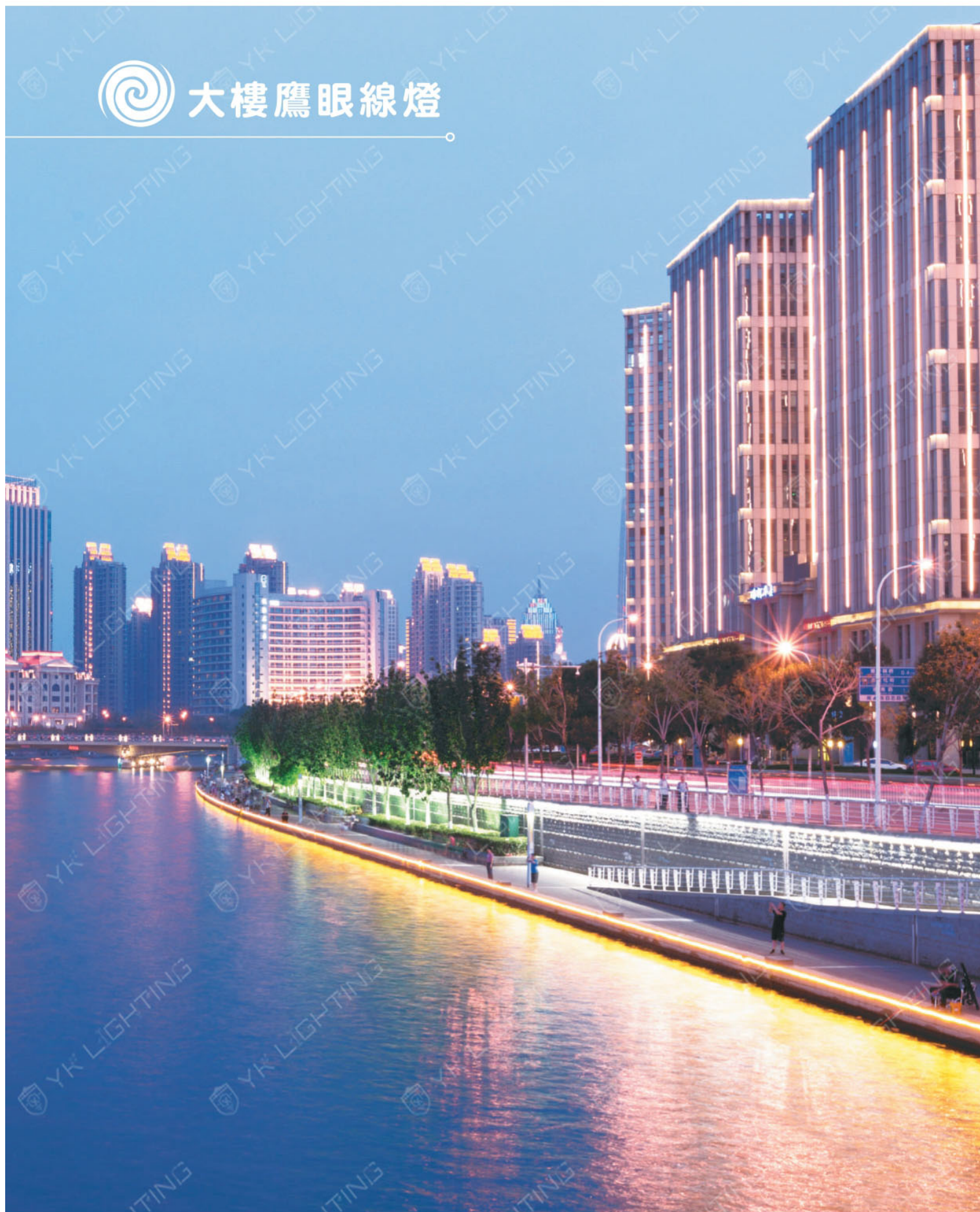



IP66 DC 24V



明緯 DC24V 另計

OD-FI12W

17,000



均光 120°(Lens)



燈腳 (可轉角度)



公母插防水設計

1. 單一驅動器，最多可串接 10 組
2. 公母插防水設計
3. 適用於大樓輪廓

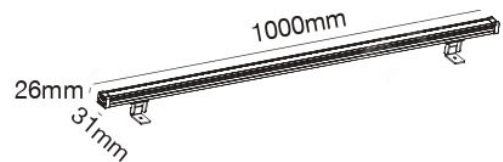

明緯 DC24V 另計

OD-FI15W-SP

20,000



聚光 30°(Lens)



燈腳 (可轉角度)



公母插防水設計

1. 單一驅動器，最多可串接 10 組
2. 公母插防水設計
3. 適用於洗建築外牆，  
可使用約 3 米高

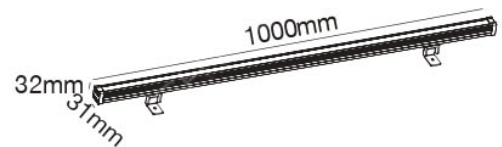

產品型號	消耗電力	光通量	發光角度	色溫	演色性	輸入電壓	燈體材質
OD-FI12W	12W	840LM	120°	3000K	≥ 80	DC 24V 外接驅動 (另計)	壓鑄鋁 PC
OD-FI15W-SP	15W	1500LM	30°				



海神防潮燈

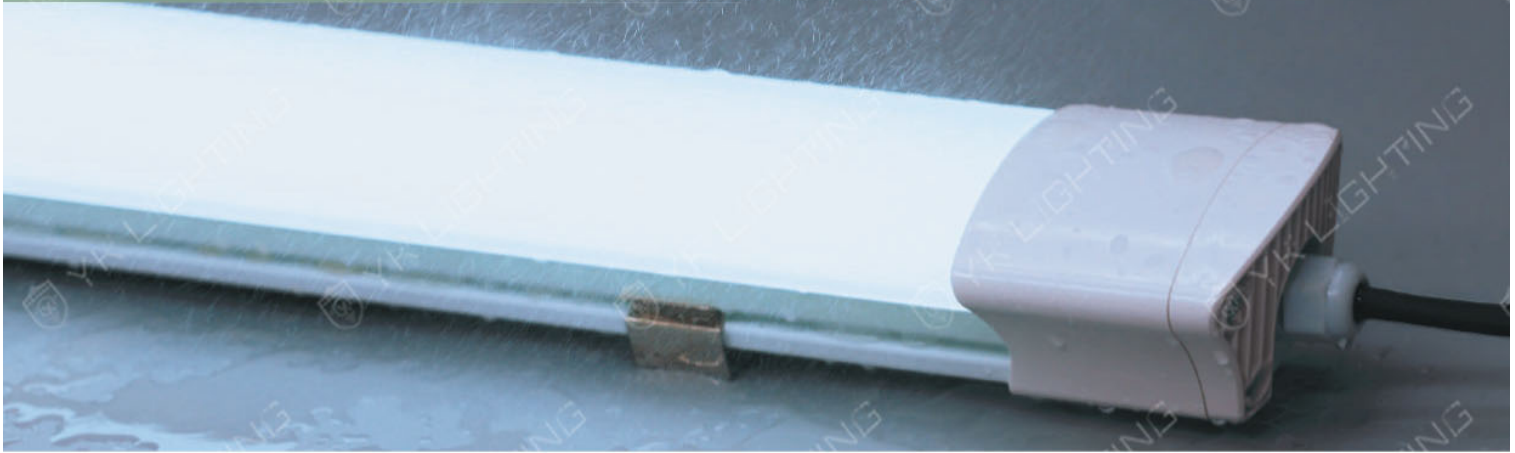

1. 一體式防潮燈
2. 均光不刺眼
3. 至多可串接 4 組
4. 抗 UV 燈罩
5. 可安裝於 -20°C 低溫環境

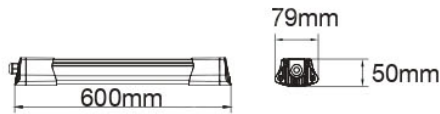

5,000

產品型號	消耗電力	色溫	光通量	演色性	輸入電壓	發光角度	燈體材質	安裝方式
OD-WA18D	18W	6500K	1620LM	≥ 80	100-240V (全電壓)	200°	PC	吸頂式
OD-WA18W		3000K	1440LM					



7,000

產品型號	消耗電力	色溫	光通量	演色性	輸入電壓	發光角度	燈體材質	安裝方式
OD-WA36D	36W	6500K	3600LM	≥ 80	100-240V (全電壓)	200°	PC	吸頂式
OD-WA36W		3000K	3240LM					

替換式防潮燈系列



OD-T8WA4X2-1 (4 尺)

OD-T8WA2X2-1 (2 尺)



OD-T8WA4X1-1 (4 尺)

OD-T8WA2X1-1 (2 尺)

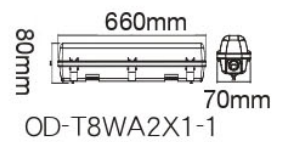
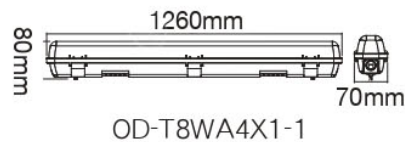
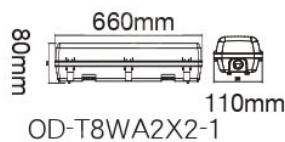
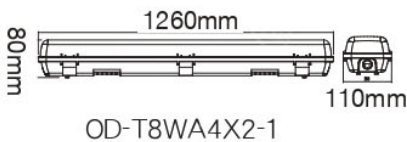

產品型號	適用光源	燈體材質	安裝方式
OD-T8WA4X2-1	LED T8 4 尺燈管 X2, 另計	不鏽鋼扣、PC	可吊、吸兩用
OD-T8WA2X2-1	LED T8 2 尺燈管 X2, 另計		
OD-T8WA4X1-1	LED T8 4 尺燈管 X1, 另計		
OD-T8WA2X1-1	LED T8 2 尺燈管 X1, 另計		



## 李奧納多戶外高燈

IP66



1. 柔光效果不刺眼
2. 抗 UV 防紫外線 PC 罩、防水驅動器壽命長
3. 戶外專用，適用公園、社區街道



內含安裝底版及基礎螺絲  
(M8xH1 35mm)

80,000

產品型號	消耗電力	色溫	光通量	演色性	輸入電壓	驅動器	發光角度	材質
OD-1503	25W	3000K	1850LM	≥ 80	100-240V (全電壓)	防水驅動器 (內附)	180°	壓鑄鋁 PC 罩 深灰色粉體防鏽烤漆



## 阿姆斯特壯戶外高燈

IP66

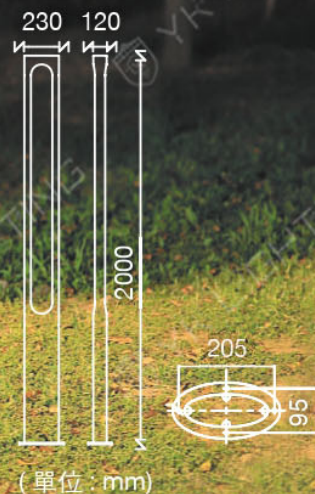

1. 特殊光型可照亮兩側地面
2. 兩米高度適合小公園、庭院



內含安裝底板及基礎螺絲  
(M8xH135mm)

80,000

產品型號	消耗電力	色溫	光通量	演色性	輸入電壓	驅動器	發光角度	材質
OD-1502	22W	3000K	1560LM	$\geq 80$	100-240V (全電壓)	防水驅動器 (內附)	140°	壓鑄鋁 深灰色 粉體防鏽烤漆



亞歷山大戶外高燈

IP66



- 1. CREE 高演色晶片造型光影
- 2. 明緯防水驅動器壽命長
- 3. 適用於公園、大樓中庭



內含安裝底板及基礎螺絲  
(M11xH315mm)



明緯驅動器 / CREE 晶片

185,000

產品型號	消耗電力	色溫	光通量	演色性	輸入電壓	驅動器	燈體材質
OD-1501	30W	3000K	1500LM	≥ 80	100V-240V (全電壓)	明緯防水驅動器(內附)	壓鑄鋁玻璃 深灰色 粉體防鏽烤漆





OD-3200-40

10,000

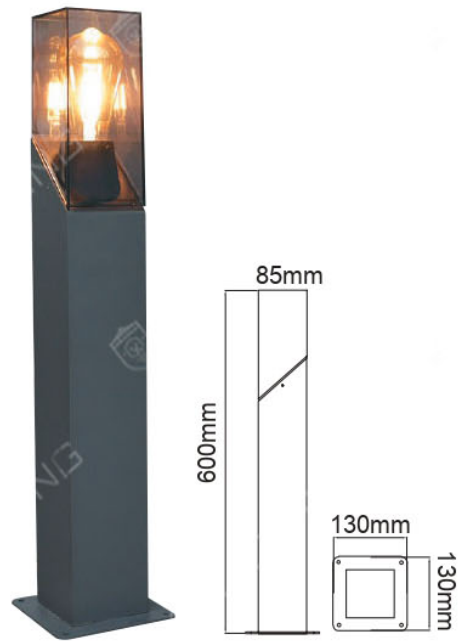

OD-3200-60

12,000

1. 簡單方形外觀設計符合現代美學
2. 抗 UV 透光黑 PC 罩搭配燈絲燈增添神秘色彩
3. 適用於步道、棧道及藝術造景等



LED-E27ED6YSTR3

### 哈利草皮燈

產品型號	高度	適用光源	燈體材質
OD-3200-40	40cm	附舞光 ST64 燈絲燈 x1	深灰色壓鑄鋁 抗 UV 透光黑 PC 罩
OD-3200-60	60cm		





1. 360 度光量柔和不眩光
2. 適用於草皮、花園等

### 肯特草皮燈

產品型號	高度	消耗電力	色溫	光通量	演色性	輸入電壓	驅動器	燈體材質
OD-3185-30	30cm	10W	3000K	600LM	≥ 80	100V-240V (全電壓)	防水驅動器 (內含)	壓鑄鋁 PC 深灰色 粉體防鏽烤漆
OD-3185-60	60cm							

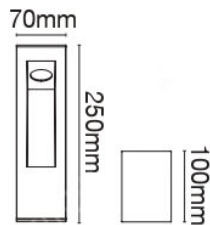

OD-3181-25

17,000

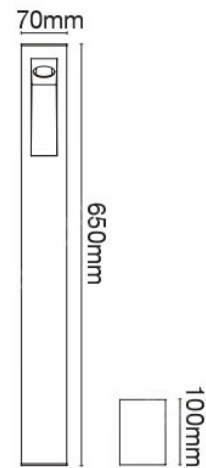

OD-3181-65

21,000

1. 外灰內金防鏽烤漆高雅時尚
2. 下照斜面結構，塑造防眩光影
3. 適用於走道、棧道等

### 威爾斯走道燈

產品型號	高度	消耗電力	色溫	光通量	演色性	輸入電壓	驅動器	燈體材質
OD-3181-25	25cm	8W	3000K	90LM	$\geq 80$	100V-240V (全電壓)	防水驅動器 (內含)	壓鑄鋁 強化玻璃 深灰色粉體防鏽烤漆
OD-3181-65	65cm							



## 約克草皮燈



1. 半月柔美光線照亮小徑
2. 時尚獨特外型設計
3. 適用於草皮、棧道等

產品型號	高度	消耗電力	色溫	光通量	演色性	輸入電壓	驅動器	發光角度	材質
OD-3182-25	25cm	8W	3000K	480LM	≥ 80	100-240V (全電壓)	防水驅動器 (內含)	55°	深灰色壓鑄鋁 強化玻璃 粉體防鏽烤漆
OD-3182-45	45cm								



## 威廉草皮燈

OD-3179-50 12,000

OD-3179-30 10,500

1. 流線外型設計，簡約的低調美
2. 導光折射的特殊結構，營造柔光優雅氛圍
3. 360°光暈適用於草皮、花園等



OD-3179-30

OD-3179-50

產品型號	高度	消耗電力	色溫	光通量	演色性	輸入電壓	驅動器	燈體材質
OD-3179-30	30cm	7W	3000K	400LM	≥ 80	100V-240V (全電壓)	防水驅動器 (內含)	壓鑄鋁 PC 深灰色 粉體防鏽烤漆
OD-3179-50	50cm							



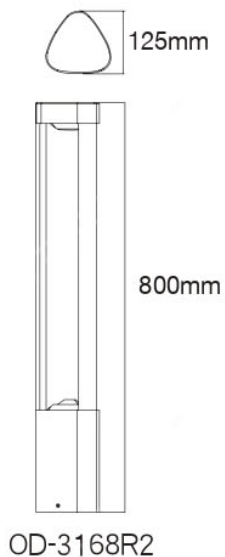
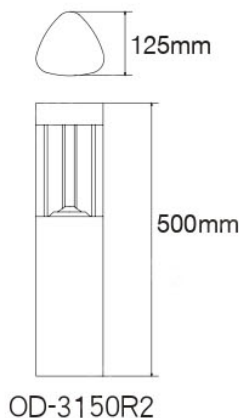
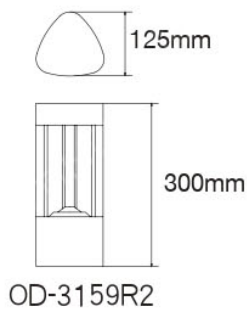

適用於草皮、花園、公園、小徑道路

1. 簡單外型設計，搭配當代簡約建築風格
2. 燈體採用壓鑄鋁和鋁型材結合，表面採用防腐蝕化學處理和抗老化靜電噴塑處理可延長燈具壽命
3. 採用擴散 PC 罩，柔和不眩光
4. 耗電僅 10W，省電 70%



多媒體說明





## 馬克草皮燈

產品型號	高度	消耗電力	色溫	光通量	演色性	輸入電壓	驅動器	發光角度	材質
OD-3159R2	30cm	10W	3000K	600LM	$\geq 80$	100-240V (全電壓)	防水驅動器 (內含)	170°	壓鑄鋁 PC 深灰色 粉體防鏽烤漆
OD-3150R2	50cm								
OD-3168R2	80cm								





# 亨利草皮燈

IP66







適用於草皮、花園、公園、小區道路

1. 簡單外型設計，搭配當代簡約建築風格
2. 燈體結構線條設計，凸顯光影之美
3. 底部階梯式結構，增添層次
4. 系列三種高度，個別特色展現

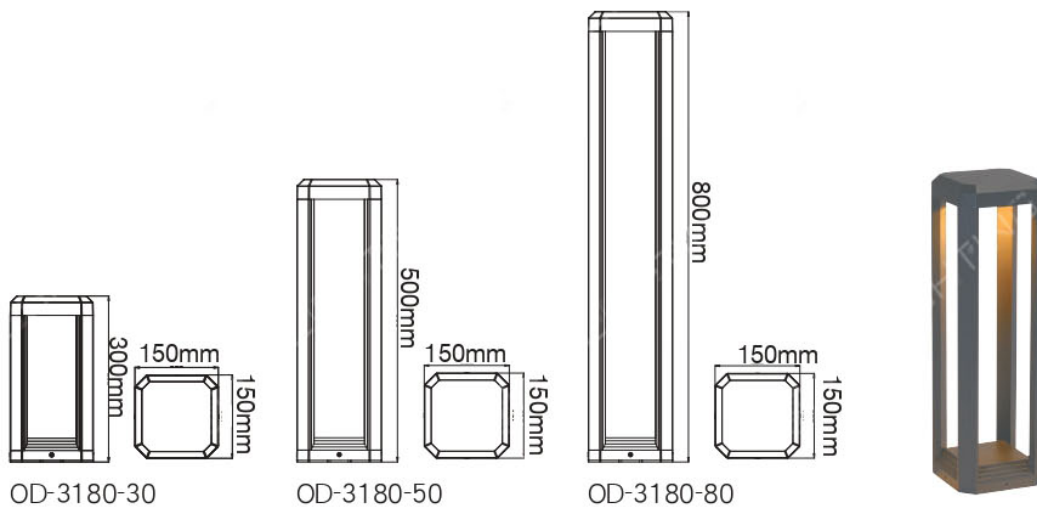

### 亨利草皮燈

30cm **14,000** 50cm **16,000** 80cm **19,000**

產品型號	高度	消耗電力	色溫	光通量	演色性	輸入電壓	驅動器	燈體材質
OD-3180-30	30cm	13W	3000K	250LM	$\geq 80$	100V-240V (全電壓)	防水驅動器 (內含)	壓鑄鋁 深灰色 粉體防鏽烤漆
OD-3180-50	50cm							
OD-3180-80	80cm							



## 亞當夏娃太陽能系列

1. 太陽能自動充電，環境光敏感測、微波啟動
2. 微波感應距離 2-4 米
3. 日照 6-8 小時，15% 亮度可使用 24 小時  
100% 亮度可使用 3 小時
4. 全亮模式 30 秒後轉待機 15%





太陽能面板 / 光感

(環境  $\leq 20\text{lux}$  自動啟動)

微波感應

(人靠近 100% 亮度)

壓鑄鋁粉體防鏽烤漆



開關長按 3 秒

(指示燈亮藍光為啟動)

夏娃 OD-2302-SE

13,000

亞當 OD-3183-50SE

19,000

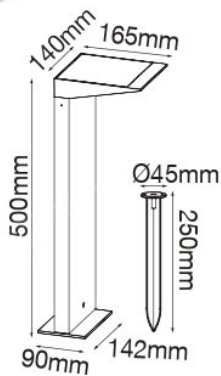

OD-3183-50SE

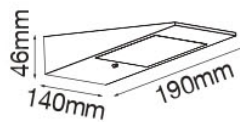

OD-2302-SE

兩種安裝方式 (插地 / 吸地)



### 亞當草皮燈 / 夏娃壁燈

產品型號	電池消耗	色溫	光通量	演色性	發光角度	輸入電壓	電池規格	燈體材質
OD-3183-50SE	2.2W	3000K	140LM	$\geq 80$	107°	DC3.7V	18650x1 2200 mAh	壓鑄鋁 PC 白色粉體防鏽烤漆
OD-2302-SE			195LM					



## 亞伯太陽能系列



1. 太陽能自動充電，環境  $\leq 20\text{LUX}$  自動啟動
2. 紅外線感應距離 2-4 米
3. 日照 6-8 小時，15% 亮度可使用 24 小時  
100% 亮度可使用 3 小時
4. 全亮模式 45 秒後轉待機 15%





太陽能面板 / 光感

(環境  $\leq 20\text{lux}$  自動啟動)



開關長按 3 秒

(指示燈亮藍光為啟動)

OD-3187-34SE

17,000

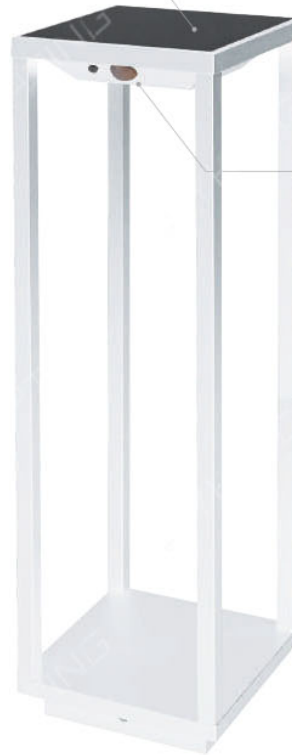

紅外線感應處

(人靠近時 100% 亮度)

OD-3187-50SE

18,500

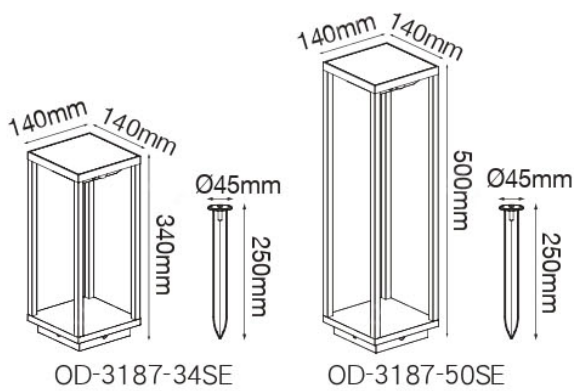

OD-3187-34SE

OD-3187-50SE

兩種安裝方式 (插地 / 吸地)



產品型號	電池消耗	色溫	光通量	演色性	發光角度	輸入電壓	電池規格	材質
OD-3187-34SE	2.2W	3000K	230LM	$\geq 80$	50°	DC3.7V	18650x1 2200 mAh	壓鑄鋁 白色粉體防鏽烤漆
OD-3187-50SE								



## 利亞諾亞太陽能系列



1. 太陽能自動充電，環境光敏感測、微波啟動
2. 微波感應距離 2-4 米
3. 日照 6-8 小時，15% 亮度可使用 24 小時  
100% 亮度可使用 3 小時
4. 全亮模式 30 秒後轉待機 15%





太陽能面板 / 光感

(環境  $\leq 20\text{lux}$  自動啟動)



開關長按 3 秒  
(指示燈亮藍色為啟動)

利亞 OD-2386-SE 19,000



諾亞 OD-3186-50SE 21,000

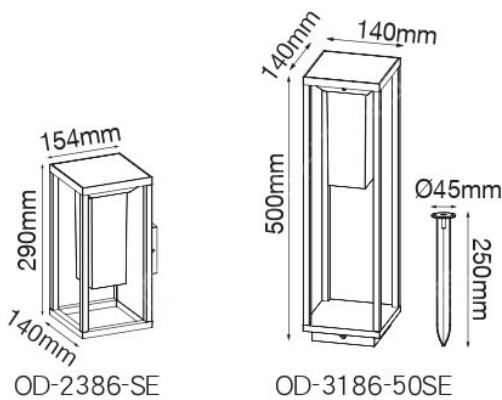

兩種安裝方式 (插地 / 吸地)



利亞壁燈  
OD-2386-SE 光型



產品型號	電池消耗	色溫	光通量	演色性	發光角度	輸入電壓	電池規格	燈體材質
OD-2386-SE	2.2W	3000K	170LM	$\geq 80$	106°	DC3.7V	18650x1 2200 mAh	壓鑄鋁 PC 燈罩 深灰色粉體防鏽烤漆
OD-3186-50SE			200LM		100°			

## 光框壁燈



※ 光框壁燈光型示意圖

1. 特殊透鏡可用於描繪三方光型、窗框、光廊
2. 適用於建築外觀照明或光線設計

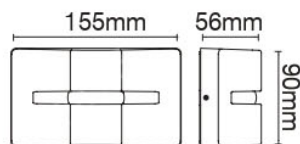

15,000

產品型號	消耗電力	色溫	光通量	演色性	輸入電壓	驅動器	發光角度	材質
OD-2343	4W	3000K	100LM	$\geq 80$	100V-240V (全電壓)	防水驅動器 (內含)	33°	壓鑄鋁 PMMA 深灰色粉體防鏽烤漆



## 艾瑪壁燈

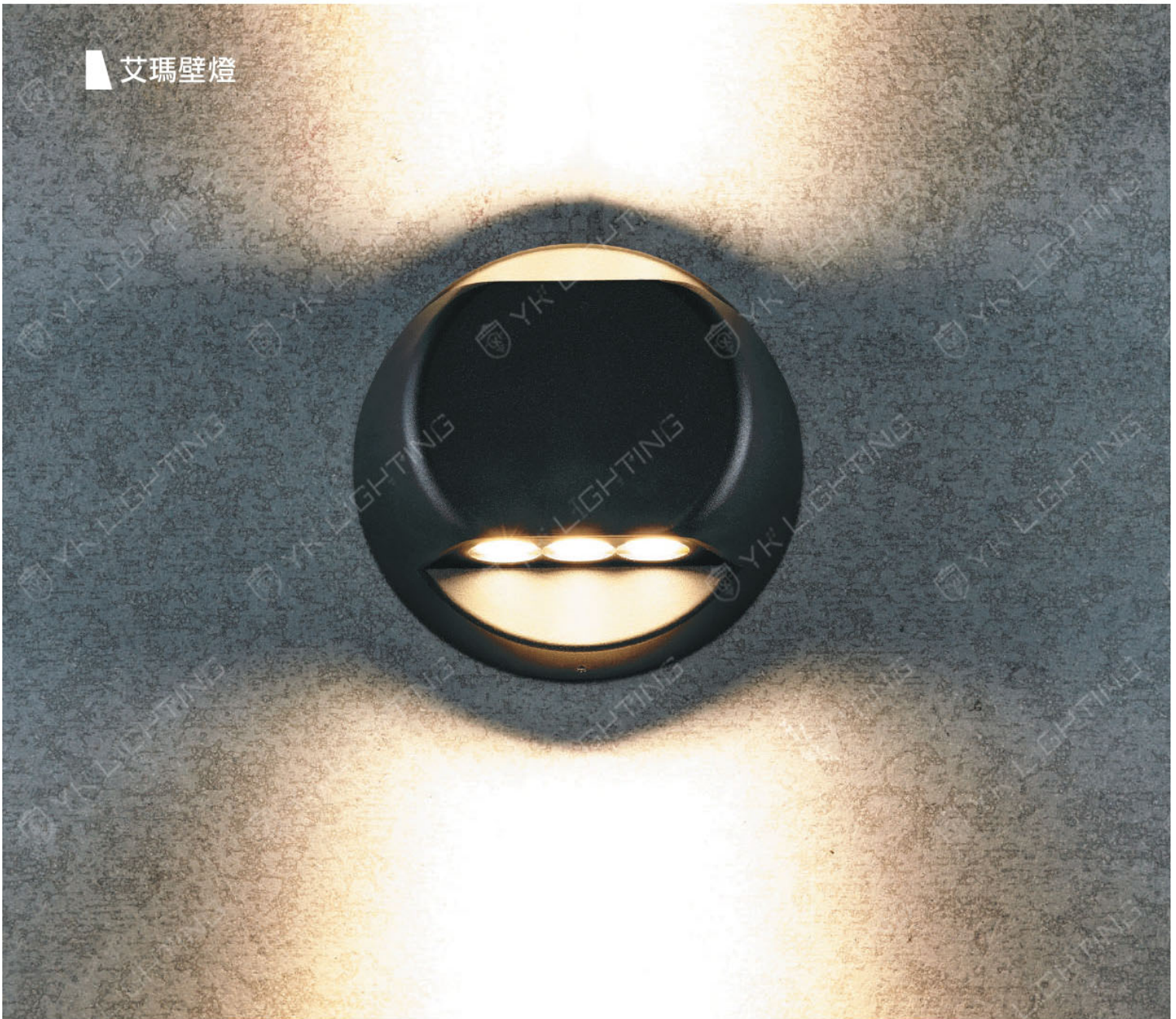

1. 簡單的線條外觀符合現代設計美學
2. 適用場所：洗亮建築物外牆、外牆柱子等

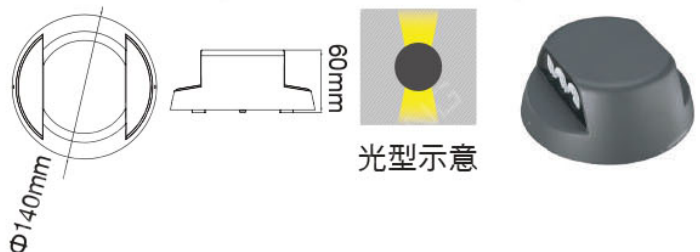

光型示意

12,000

產品型號	消耗電力	色溫	光通量	演色性	輸入電壓	驅動器	發光角度	材質
OD-2249	8W	3000K	400LM	$\geq 80$	100V-240V (全電壓)	防水驅動器 (內含)	140°	壓鑄鋁 強化玻璃 深灰色粉體防鏽烤漆



### 艾蜜莉壁燈

### 月光壁燈



1. 均勻柔和光線設計可直 / 橫式安裝
2. 壓鑄鋁燈體材質表面採用防腐蝕處理

1. 仿月光月暈設計
2. 磁式面蓋無螺絲設計

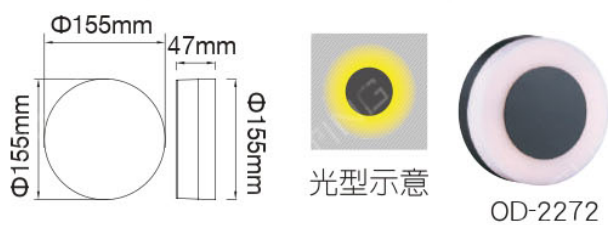
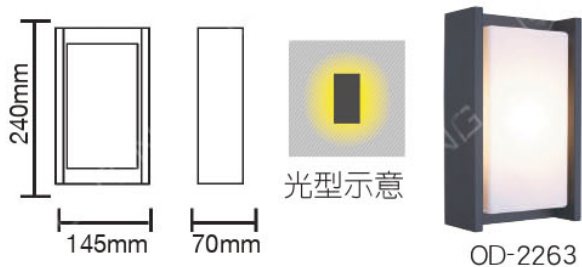

12,000

產品型號	消耗電力	色溫	光通量	演色性	輸入電壓	驅動器	材質
OD-2263	8W	3000K	210LM	≥ 80	100V-240V (全電壓)	防水驅動器 (內含)	壓鑄鋁 PC 深灰色粉體防鏽烤漆
OD-2272	10W		500LM				



## 金磚壁燈



1. 上下柔和均光面
2. 抗 UV 防紫外線 PC
3. 適用於建築外牆、門廊等

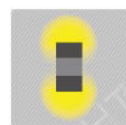
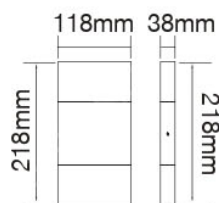

光型示意



14,000

產品型號	消耗電力	色溫	光通量	演色性	輸入電壓	驅動器	材質
OD-2273	10W	3000K	480LM	$\geq 80$	100V-240V (全電壓)	防水驅動器 (內含)	壓鑄鋁 PC 深灰色粉體防鏽烤漆

## 愛麗絲壁燈



1. 現代美學流線型燈體設計
2. 上下精緻光型
3. 適用於建築外牆、庭院

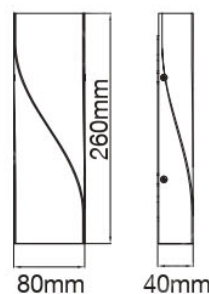

10,000

產品型號	消耗電力	色溫	光通量	演色性	輸入電壓	驅動器	發光角度	燈體材質
OD-2350	11W	3000K	560LM	$\geq 80$	100V-240V (全電壓)	防水驅動器 (內含)	120°	壓鑄鋁 鋼化玻璃 深灰色粉體防鏽烤漆



## 凱莉壁燈



1. 簡約幾何線條設計風格
2. 上下光型柔和不眩光
3. 適用於門廊、大樓外牆

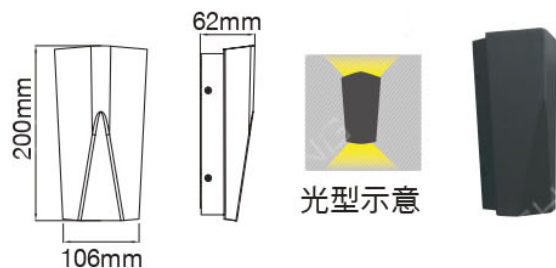

12,000



產品型號	消耗電力	色溫	光通量	演色性	輸入電壓	驅動器	發光角度	燈體材質
OD-2351	11W	3000K	530LM	$\geq 80$	100V-240V (全電壓)	防水驅動器 (內含)	140° 130°	壓鑄鋁 鋼化玻璃 深灰色粉體防鏽烤漆

## 雙窗壁燈



1. 獨特雙邊窗型設計，可手動自由調整光線角度，創造喜好的光影變化
2. 方型簡約線條設計，百搭各式牆面，高雅時尚

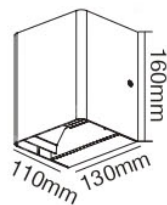

可調角度

15,000

產品型號	消耗電力	色溫	光通量	演色性	輸入電壓	驅動器	發光角度	材質
OD-2349	18W	3000K	1000LM	$\geq 80$	100-240V (全電壓)	防水驅動器 (內含)	140°	壓鑄鋁 深灰色 粉體防鏽烤漆



## 夏綠蒂壁燈

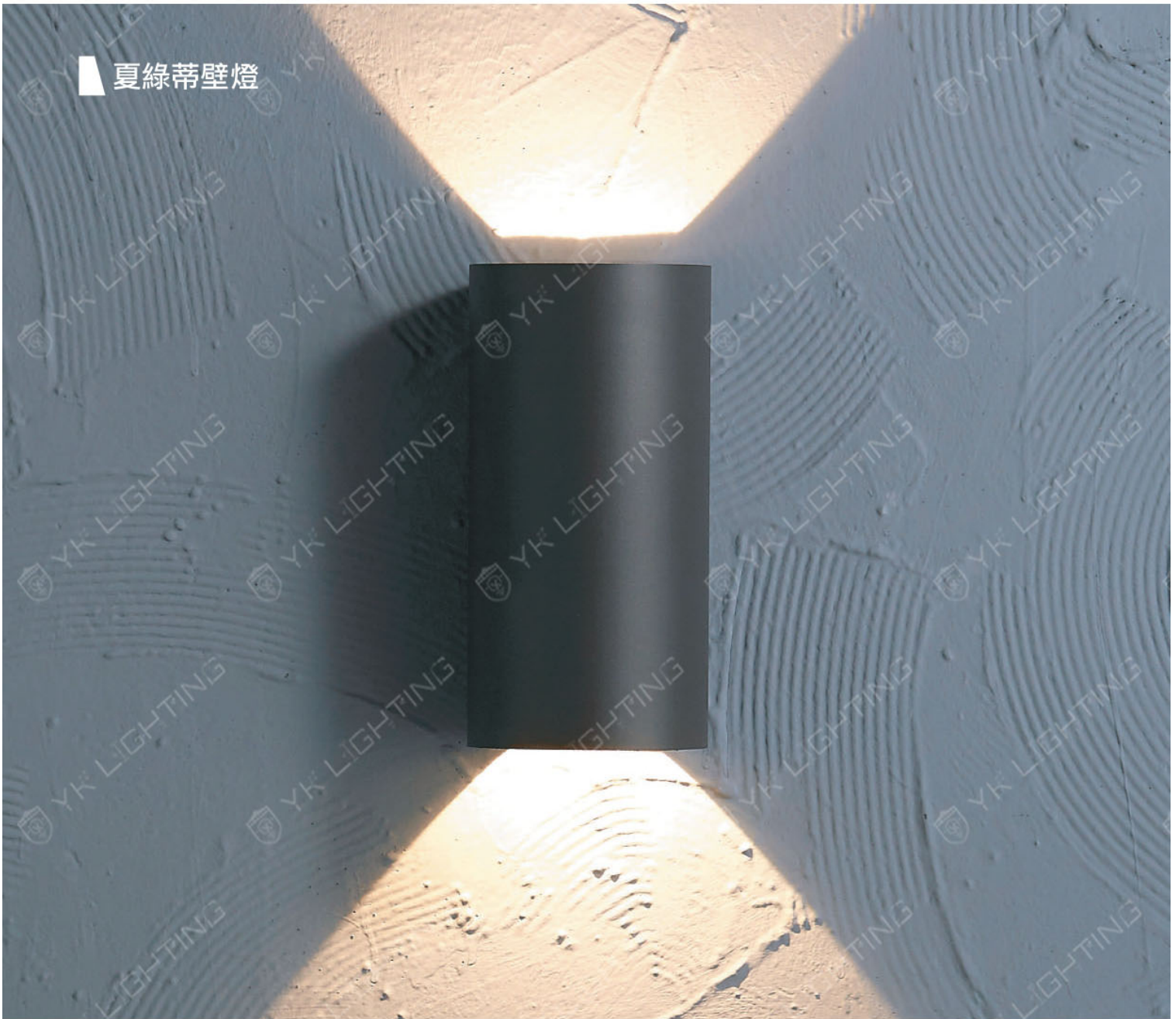

1. 圓筒型鏤空特色設計
2. 上下洗光，輕鬆描繪牆面、牆柱、建築線條光影
3. 簡約線條設計，百搭各式牆面，高雅時尚

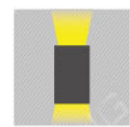
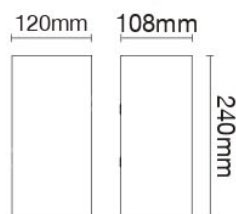

光型示意



俯視圖

19,000

產品型號	消耗電力	色溫	光通量	演色性	輸入電壓	驅動器	發光角度	材質
OD-2299	13W	3000K	725LM	≥ 80	100V-240V (全電壓)	防水驅動器 (內含)	73°	壓鑄鋁 鋼化玻璃 深灰色粉體防鏽烤漆

## 泰勒絲壁燈



1. 添加曲線燈體凸顯美感
2. 精緻雕琢光型
3. 適用於建築外牆、庭園等

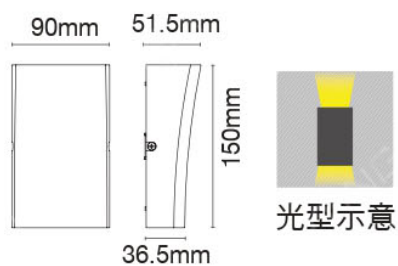

12,000

產品型號	消耗電力	色溫	光通量	演色性	輸入電壓	驅動器	發光角度	燈體材質
OD-2298	6W	3000K	340LM	$\geq 80$	100V-240V (全電壓)	防水驅動器 (內含)	107° 91°	壓鑄鋁 鋼化玻璃 深灰色粉體防鏽烤漆



溫莎壁燈



1. 零死角完美弧型
2. 獨特光型角度 45°/ 130°
3. 適用於建築外牆、門廊等



光型示意



10,000

產品型號	消耗電力	色溫	光通量	演色性	輸入電壓	驅動器	發光角度	燈體材質
OD-2297	11W	3000K	360LM	≥ 80	100V-240V (全電壓)	防水驅動器 (內含)	45°	壓鑄鋁 鋼化玻璃 深灰色粉體防鏽烤漆
							130°	

## 魔術壁燈



1. 可任意排列變換字型
2. 下方光影洗牆設計
3. 適用於建築外牆、門口等

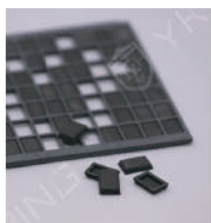

排字板

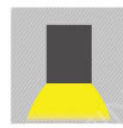
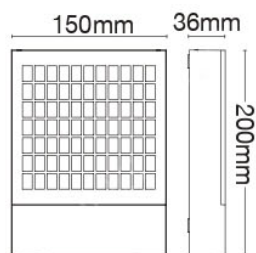

光型示意



19,000

產品型號	消耗電力	色溫	光通量	演色性	輸入電壓	驅動器	發光角度	材質
OD-2342	4W	3000K	150LM	≥ 80	100V-240V (全電壓)	防水驅動器 (內含)	150°	壓鑄鋁、強化玻璃 塑料排字板 深灰色粉體防鏽烤漆



## 數字壁燈



1. 內附 3 組數字貼紙，可 DIY 排列號碼
2. 均光柔和無暗區
3. 適用於門牌或壁燈等照明

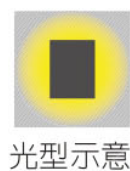
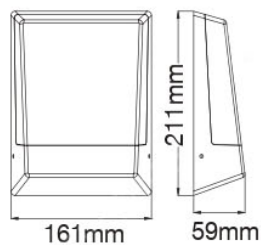

9,000

產品型號	消耗電力	色溫	光通量	演色性	輸入電壓	驅動器	發光角度	材質
OD-2348R1	4W	3000K	400LM	$\geq 80$	100V-240V (全電壓)	防水驅動器 (內含)	117°	壓鑄鋁 PC 深灰色粉體防鏽烤漆

## 圓轉壁燈

IP65



1. 轉動外框改變照射方向，可隨環境調整
2. 均勻柔和光線設計，可直 / 橫式安裝
3. 磁式面蓋無螺絲設計
4. 適用於建築外牆等

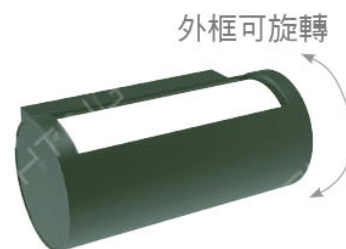
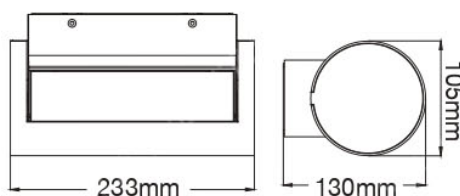

外框可旋轉

16,000

產品型號	消耗電力	色溫	光通量	演色性	輸入電壓	驅動器	發光角度	燈體材質
OD-2346	13W	3000K	250LM	$\geq 80$	100V-240V (全電壓)	防水驅動器 (內含)	114°	壓鑄鋁 PC 深灰色粉體防鏽烤漆





1. 四種光型呈現，可隨環境調整

2. 室內 / 戶外兩用

※ 限裝裝潢板

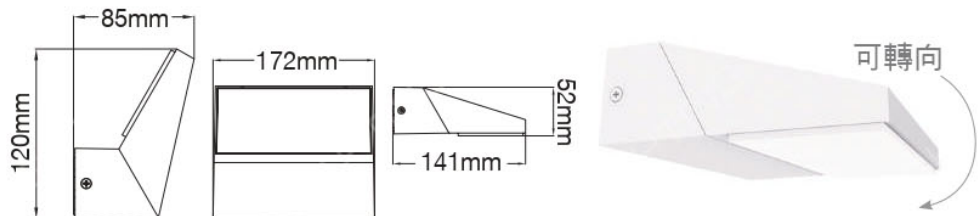

14,000

產品型號	消耗電力	色溫	光通量	演色性	輸入電壓	驅動器	發光角度	燈體材質
OD-2347	13W	3000K	715LM	$\geq 80$	100V-240V (全電壓)	防水驅動器 (內含)	130°	壓鑄鋁 PC 白色粉體防鏽烤漆



## 安妮壁燈



1. 中空時尚設計
2. 防眩柔和光影

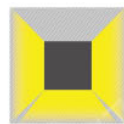
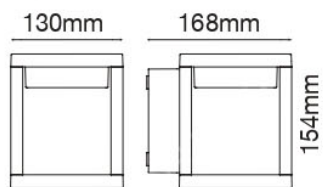

光型示意



19,000

產品型號	消耗電力	色溫	光通量	演色性	輸入電壓	驅動器	發光角度	材質
OD-2300	13W	3000K	950LM	≥ 80	100V-240V (全電壓)	防水驅動器 (內含)	115°	壓鑄鋁 PC 深灰色粉體防鏽烤漆



伊莉莎白壁燈



1. 均勻質感透光
2. 防眩霧面玻璃設計
3. 適用於建築外牆、門廊等空間

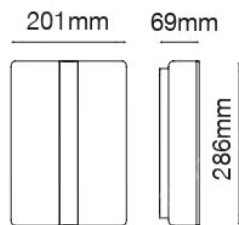

光型示意



22,000

產品型號	消耗電力	色溫	光通量	演色性	輸入電壓	驅動器	發光角度	材質
OD-2301	13W	3000K	650LM	$\geq 80$	100V-240V (全電壓)	防水驅動器 (內含)	113°	壓鑄鋁 鋼化玻璃 深灰色粉體防鏽烤漆



## 布蘭琪壁燈



1. 均勻雙邊發光，可直 / 橫安裝
2. 適用於建築外牆、門口等

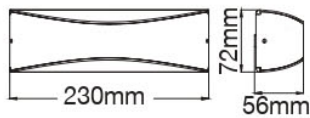

防水艙

10,000

產品型號	消耗電力	色溫	光通量	演色性	輸入電壓	驅動器	發光角度	材質
OD-2345	7W	3000K	345LM	$\geq 80$	100V-240V (全電壓)	防水驅動器 (內含)	200°	壓鑄鋁 PC 白色粉體防鏽烤漆



## 邦妮壁燈



1. 三面防眩側發光
2. 磁式面蓋無螺絲設計
3. 適用於車道或梯角等走道照明

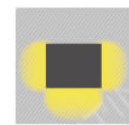
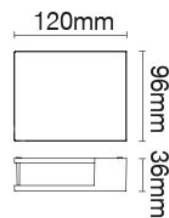

光型示意



12,000

產品型號	消耗電力	色溫	光通量	演色性	輸入電壓	驅動器	發光角度	材質
OD-2341	4W	3000K	220LM	$\geq 80$	100V-240V (全電壓)	防水驅動器 (內含)	190°	壓鑄鋁 PC 白色粉體防鏽烤漆



12W 洗牆地底燈 IP66

內部燈板可轉角 15°



1. 304 不銹鋼面框耐磨損
2. 窄角高洗牆適用 4 米高
3. 內部角度可轉 15°
4. 強化玻璃厚度 10mm



光型示意



21,000

產品型號	消耗電力	色溫	光通量	演色性	光束角	輸入電壓	驅動器	燈體材質
OD-4139	12W	3000K	1200LM	≥ 80	20°	100V-240V (全電壓)	防水驅動器 (內含)	不銹鋼 強化玻璃 壓鑄鋁





## 洗牆地底燈 / 視覺引導地底燈 IP66



光型示意



4W 洗牆地底燈

11,000

產品型號	OD-4135W
消耗電力	4W
輸入電壓	100-240V (全電壓)
驅動器	防水驅動器 (內含)
色溫	3000K(黃光)
光通量	250LM
演色性	≥ 80
光束角	45°
燈體材質	不鏽鋼、玻璃、附預埋盒

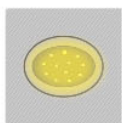

光型示意



1.2W 視覺引導地底燈

8,000

產品型號	OD-4123BR5
消耗電力	1.2W
輸入電壓	100-240V (全電壓)
驅動器	防水驅動器 (內含)
色溫	藍光
光通量	-
演色性	≥ 80
光束角	150°
燈體材質	不鏽鋼、玻璃、附預埋盒

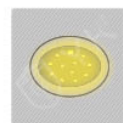

光型示意



1.2W 視覺引導地底燈

8,000

產品型號	OD-4123WR5
消耗電力	1.2W
輸入電壓	100-240V (全電壓)
驅動器	防水驅動器 (內含)
色溫	3000K(黃光)
光通量	90LM
演色性	≥ 80
光束角	150°
燈體材質	不鏽鋼、玻璃、附預埋盒



LED 階梯視覺引導步道燈 IP66

1. 可做為夜間指引燈，省電又安全
2. 不需預埋盒，不需挖孔，可適用台灣建築預埋盒，安裝便利
3. 內附全電壓驅動器，安裝方便
4. 適搭配傳統無夜燈之開關



7,000

產品型號	OD-4132R1
消耗電力	1.5W
輸入電壓	100-240V (全電壓)
驅動器	防水驅動器(內含)
色溫	藍光
光通量	-
燈體材質	304 不鏽鋼黑面蓋、PC
嵌入孔	L: 65mm W: 45mm H: 21mm

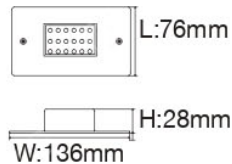

7,000

產品型號	OD-4133R1
消耗電力	1.5W
輸入電壓	100-240V (全電壓)
驅動器	防水驅動器(內含)
色溫	3000K(黃光)
光通量	130LM
燈體材質	304 不鏽鋼黑面蓋、PC
嵌入孔	L: 65mm W: 45mm H: 21mm

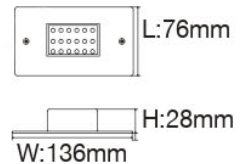

7,000

產品型號	OD-4132R1-S
消耗電力	1.5W
輸入電壓	100-240V (全電壓)
驅動器	防水驅動器(內含)
色溫	藍光
光通量	-
燈體材質	304 不鏽鋼銀面蓋、PC
嵌入孔	L: 65mm W: 45mm H: 21mm

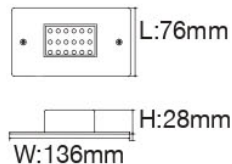

7,000

產品型號	OD-4133R1-S
消耗電力	1.5W
輸入電壓	100-240V (全電壓)
驅動器	防水驅動器(內含)
色溫	3000K(黃光)
光通量	130LM
燈體材質	304 不鏽鋼銀面蓋、PC
嵌入孔	L: 65mm W: 45mm H: 21mm

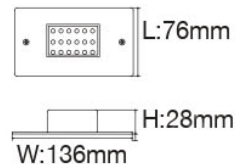





- 1. 方形防眩照亮步道
- 2. 內附預埋盒
- 3. 適用於階梯、花園旁等

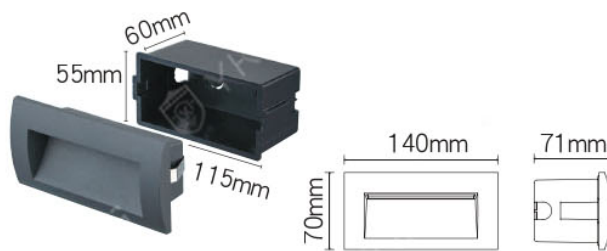

10,000

產品型號	消耗電力	色溫	光通量	演色性	輸入電壓	驅動器	燈體材質	嵌入孔
OD-4136W-BK	3W	3000K	90LM	≥ 80	100V-240V (全電壓)	防水驅動器 (內含)	壓鑄鋁 深灰色	L:115mm W: 55mm D: 60mm



防眩圓型階梯燈

IP66

1. 圓形防眩光照亮路徑
2. 精巧別緻外觀
3. 內附預埋盒
4. 適用於階梯、車道等

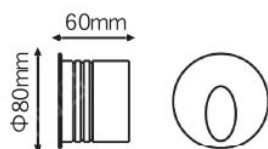

10,000

產品型號	消耗電力	色溫	光通量	演色性	發光角度	輸入電壓	驅動器	燈體材質	嵌入孔
OD-4137	3W	3000K	150LM	≥ 80	50°	100V-240V (全電壓)	防水驅動器 (內含)	壓鑄鋁 亮銀色	Φ77mmx70mm





戶外照樹燈

IP66



防眩燈罩

OD-3162 (8W) 16,000



(可改吸地, OD-3051-CN2 底座另計)

OD-3175R2 (5W) 8,600

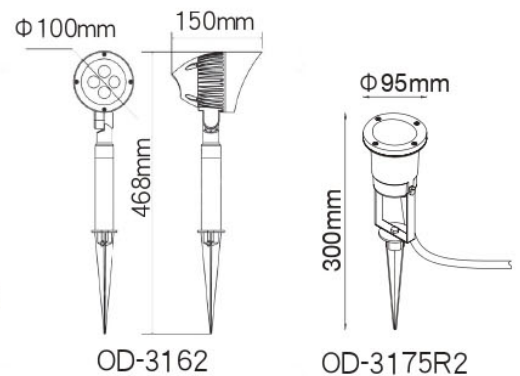

OD-3162

OD-3175R2

1. 可照亮 3-6 米以上花園、樹木、草皮、雕塑或建築物特色處
2. 活動性關節可上下調整，可對準想照亮的地方

產品型號	消耗電力	色溫	光通量	演色性	輸入電壓	驅動器	光束角	燈體材質
OD-3162	8W	3000K	500LM	≥ 80	100V-240V (全電壓)	防水驅動器 (內含)	30°	壓鑄鋁 深灰色粉體防鏽烤漆
OD-3175R2	5W		400LM				45°	

## 聚光洗柱燈

IP66

1. 18W 適裝 7 米高外柱，30W 適裝 10 米高外柱
2. 採用 CREE 高效率晶片、高演色性
3. 獨特防水堵線設計
4. 通過 IP66 防水等級

高 7 米寬 1 米 (OD-3177SP 實景拍攝)



OD-3184SP

21,000



OD-3177SP

15,000

產品型號	消耗電力	色溫	光通量	演色性	輸入電壓	驅動器	光束角	燈體材質	固定方式
OD-3184SP	30W	3000K	2700LM	≥ 80	100V-240V (全電壓)	防水驅動器 (內含)	15°	壓鑄鋁 強化玻璃	吸地式
OD-3177SP	18W		1450LM						吸地式 / 插地式 (插地棒另計)



## 照樹燈

IP66

1. 9W 適裝於矮樹叢
2. 18W 適用於 5~6 米高樹
3. 獨特防水堵線設計
4. 通過 IP66 防水等級
5. 安裝於草地請使用插地棒，  
避免燈具泡水損壞

高 3.5 米寬 4 米 (OD-3177 實景拍攝)



OD-3177

15,000



OD-3174

11,000

插地棒

OD-3174-CN1

(長度 160mm)

產品型號	消耗電力	色溫	光通量	演色性	輸入電壓	驅動器	光束角	燈體材質	固定方式
OD-3177	18W	3000K	1450LM	≥ 80	100V-240V (全電壓)	防水驅動器 (內含)	35°	壓鑄鋁 強化玻璃	吸地式 / 插地式 (插地棒另計)
OD-3174	9W		700LM				30°		



# 燈泡家族

## Bulb Family



  
**舞光 · LED**

優質  
平價

多元  
創新

保固  
承諾



■ 通過 2021 年最新 CNS 規範 105lm/w 超省電

■ 無藍光危害

■ EMI 防干擾

■ 高演色性

■ 長壽命



# 低天井商業用



## E40 75W 燈泡 < 2022 Q3 改版 >



內附防墜繩

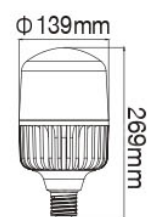

13,000

產品型號	消耗電力	色溫	光通量	演色性	輸入電壓	發光角度	燈體材質
LED-E4075DR1	75W	6500K	10000LM	≥ 80	100V-277V (全電壓)	300°	壓鑄鋁 PC 罩
LED-E4075WR1	75W	3000K	9500LM				

\* 操作環境：避免安裝於密閉式燈具且燈具環境溫度超過 60°C

## E27 50W 燈泡 < 2022 Q3 改版 >



E27

8,500

產品型號	消耗電力	色溫	光通量	演色性	輸入電壓	發光角度	燈體材質
LED-E2750DR1	50W	6500K	5500LM	≥ 80	100-277V (全電壓)	300°	塑包鋁 PC 罩
LED-E2750WR1	50W	3000K	5300LM				

\* 操作環境：避免安裝於密閉式燈具且燈具環境溫度超過 60°C

## E27 38W 燈泡

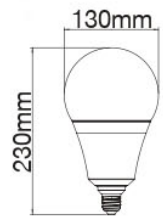

5,500

產品型號	消耗電力	色溫	光通量	演色性	輸入電壓	發光角度	燈體材質
LED-E2738DR2	38W	6500K	4200LM	≥ 80	100-240V (全電壓)	300°	塑包鋁 PC罩
LED-E2738WR2	38W	3000K	4000LM				

\* 操作環境：避免安裝於密閉式燈具且燈具環境溫度超過 60°C

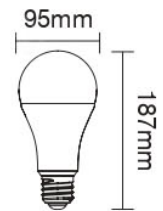
E27 25W 燈泡  
< 2022 Q2 上市 >

3,200

產品型號	消耗電力	色溫	光通量	演色性	輸入電壓	發光角度	燈體材質
LED-E2725DR2	25W	6500K	2750LM	≥ 80	100-240V (全電壓)	300°	塑包鋁 PC罩
LED-E2725WR2	25W	3000K	2650LM				

\* 操作環境：避免安裝於密閉式燈具且燈具環境溫度超過 60°C



E27 PAR38 兩用型投射燈泡

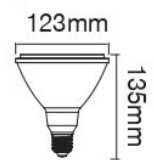

4,600

產品型號	消耗電力	色溫	光通量	演色性	輸入電壓	光束角	燈體材質
LED-PAR3814WR6	14W	3000K	1300LM	≥ 80	100-240V (全電壓)	36°	塑包鋁 PC罩

\* 操作環境：避免安裝於密閉式燈具且燈具環境溫度超過 60°C

## 12/16W 節能標章燈泡

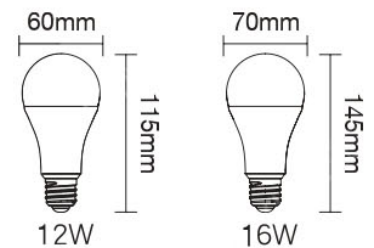

產品型號	消耗電力	色溫	光通量	演色性	輸入電壓	發光角度	燈體材質
LED-E2712DR7	12W	6500K	1450LM	≥ 80	100V-240V (全電壓)	300°	塑包鋁 PC罩
LED-E2712NR7		4000K	1450LM				
LED-E2712WR7		3000K	1350LM				
LED-E2716DR7	16W	6500K	1920LM				
LED-E2716NR7		4000K	1920LM				
LED-E2716WR7		3000K	1760LM				



## 16W 全電壓燈泡

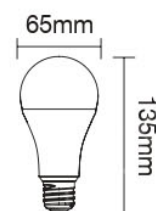

產品型號	消耗電力	色溫	光通量	演色性	輸入電壓	發光角度	燈體材質
LED-E2716DR6	16W	6500K	1760LM	≥ 80	100-240V (全電壓)	300°	塑包鋁 PC罩
LED-E2716NR6	16W	4000K	1760LM				
LED-E2716WR6	16W	3000K	1680LM				

## 12W 全電壓燈泡



產品型號	消耗電力	色溫	光通量	演色性	輸入電壓	發光角度	燈體材質
LED-E2712DR6	12W	6500K	1320LM	≥ 80	100-240V (全電壓)	300°	塑包鋁 PC罩
LED-E2712NR6	12W	4000K	1320LM				
LED-E2712WR6	12W	3000K	1260LM				

## 10W 冰棒燈



適用窄小燈具

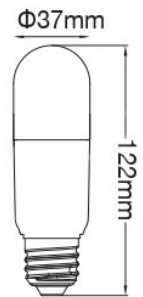

產品型號	消耗電力	色溫	光通量	演色性	輸入電壓	發光角度	燈體材質
LED-E27F10D	10W	6500K	1100LM	≥ 80	100-240V (全電壓)	330°	塑包鋁 PC罩
LED-E27F10N	10W	4000K	1100LM				
LED-E27F10W	10W	3000K	1050LM				



R6

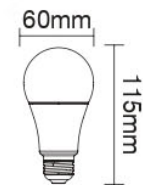

R7

## 10W 全電壓燈泡

產品型號	消耗電力	色溫	光通量	演色性	輸入電壓	發光角度	燈體材質
LED-E2710DR6(R7)	10W	6500K	1100LM (R6) 1200LM (R7)	≥ 80	100-240V (全電壓)	300°	塑包鋁 PC罩
LED-E2710NR6(R7)	10W	4000K	1100LM (R6) 1200LM (R7)				
LED-E2710WR6(R7)	10W	3000K	1050LM (R6) 1100LM (R7)				

## 7W 全電壓燈泡

產品型號	消耗電力	色溫	光通量	演色性	輸入電壓	發光角度	燈體材質
LED-E277DR6(R7)	7W	6500K	770LM (R6) 840LM (R7)	≥ 80	100-240V (全電壓)	300°	塑包鋁 PC罩
LED-E277WR6(R7)	7W	3000K	735LM (R6) 780LM (R7)				



## E27 引掛式燈座



日式

LED-CEE27A

900



歐風

LED-CEE27B

1,000



LED-CEE27A 吊卡式包裝 LED-CEE27B 吊卡式包裝 LED-CEE27BR1 盒裝

產品型號	尺寸	適用光源	燈體材質	包裝方式
LED-CEE27A	Φ109xH:60mm	E27x1 另計	電黃銅、陶瓷 耐熱工程塑膠	吊卡式
LED-CEE27B	Φ135xH:60mm			
LED-CEE27BR1	Φ135xH:60mm			盒裝

## 12W 全日型感應燈泡



CCAG20LP0372T8  
國家通訊傳播委員會



1. 符合 NCC 通訊傳播委員會頻段
2. 通過 CNS 無藍光危害認證
3. 感應直徑：2-6 米
4. 亮燈時間：1 分鐘
5. 人經過感應範圍啟動點亮，  
一分鐘自動熄滅，智慧節電



3,000

產品型號	消耗電力	色溫	光通量	演色性	輸入電壓	發光角度	燈體材質
LED-E2712DR2-MS	12W	6500K	1300LM	≥ 80	100V-240V (全電壓)	300°	塑包鋁 PC 罩
LED-E2712WR2-MS	12W	3000K	1260LM				





## 12W 調光燈泡



1. 適用市場容易取得安裝的電阻式調光器
2. 同步調光亮度一致
3. 穩定調光不閃爍
4. 最多同時調光 5 顆
5. 隨自己活動需求調整亮度，節約能源

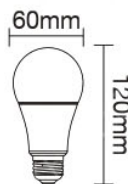

適用



電阻式調光器  
CL-008/1-500W

檯燈調光線  
CL-007B-1



多媒體說明

2,800

產品型號	消耗電力	色溫	光通量	演色性	輸入電壓	發光角度	燈體材質
LED-E2712WDMR6	1W-12W (110V)	3000K	100-1260LM	≥ 80	100V-240V (全電壓)	300°	塑包鋁 PC罩

# 12W 驅蚊燈泡

驅蚊  
專用非照  
明用

多媒體說明

LED 低誘蟲燈泡發出的色光，有別於傳統藍冷光，而是以黃中帶紅之暖色調取代。將昆蟲在夜間喜愛聚集的 500nm 以下波長加以截斷，造成蚊蟲的視覺障礙。

當蚊蟲進入照射範圍內，眼前會陷入一片黑暗，暫時失去視覺功能，造成恐懼不敢靠近而飛走，藉此達到驅蟲效果。

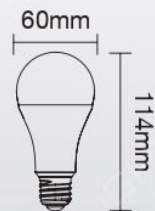
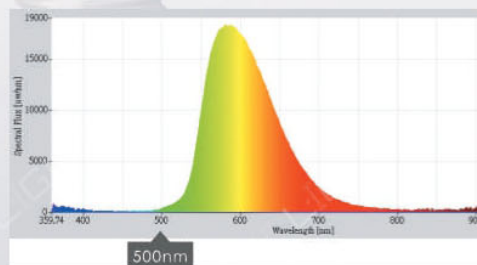

2,000

產品型號	消耗電力	色溫	光通量	輸入電壓	發光角度	燈體材質
LED-E2712Y	12W	2200K (500~750nm)	680LM	100V-240V (全電壓)	300°	散熱塑





LED-E273DR6



LED-E273WR6

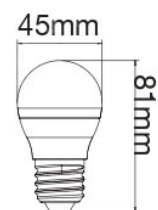

### 3W 全電壓燈泡

產品型號	消耗電力	色溫	光通量	演色性	輸入電壓	發光角度	燈體材質
LED-E273DR6	3W	6500K	370LM	≥ 80	100-240V (全電壓)	300°	塑包鋁 PC罩
LED-E273WR6		3000K	360LM				



LED-E273RR1



LED-E273BR1



LED-E273GR1

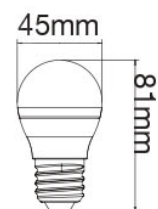

多媒體說明

### 3W 全電壓彩色燈泡

900

產品型號	消耗電力	波長	輸入電壓	發光角度	燈體材質
LED-E273RR1	3W	620nm(紅色)	100-240V (全電壓)	300°	塑包鋁 PC罩
LED-E273BR1		460nm(藍色)			
LED-E273GR1		540nm(綠色)			

## 4W 羅浮宮蠟燭燈



LED-E144WCR6 (尖清)



LED-E144WC/ TAR6 (拉尾)



1. 超高亮度，比一般 LED 蠟燭燈亮 3 倍
2. 導光柱設計展現特殊光影

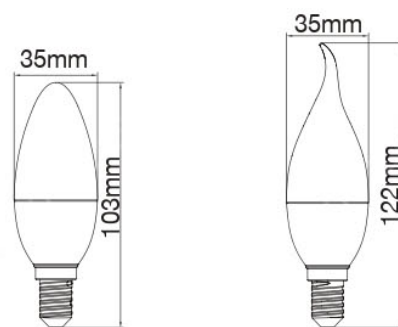

LED-E144WCR6

LED-E144WC/TAR6

1,200

產品型號	消耗電力	色溫	光通量	演色性	燈頭	輸入電壓	發光角度	燈體材質
LED-E144DCR6	4W	6500K	480LM	≥ 80	E14 尖清	100V   240V (全電壓)	200°	塑包鋁質 PC 罩
LED-E144WCR6		3000K	450LM					
LED-E144WC/TAR6		3000K	450LM					



## 0.5W 小夜燈



LED-E120.5WR1



LED-E120.5RR1

E12 神明小夜燈 (兩入裝)

850



LED-E270.5WR1



LED-E270.5RR1

E27 小夜燈

550

1. 超省電，和傳統神明燈相比省電 90% 以上
2. 壽命長，和傳統神明燈相比壽命長 10 倍以上

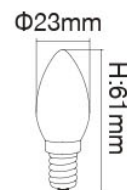

LED-E120.5WR1



LED-E270.5WR1

產品型號	消耗電力	色溫	光通量	演色性	燈頭	輸入電壓	發光角度	燈體材質
LED-E120.5WR1	0.5W	3000K	40LM	$\geq 80$	E12	110V	300°	鋁燈頭 PC 罩
LED-E120.5RR1		紅	-	-				
LED-E270.5WR1		3000K	40LM	$\geq 80$	E27			
LED-E270.5RR1		紅	-	-				



## 舞光燈絲燈



溫暖色溫營造溫馨光氛圍，總帶給人放鬆休憩的感受

1. 最佳導熱基板
2. 等同白熾燈完美光型
3. 高亮度省電 95%(與白熾燈比較)
4. 長壽命 15000 小時，白熾燈的 15 倍



## LED Filament Bulb 燈絲燈



多媒體說明



產品型號	消耗電力	色溫	光通量	燈頭	演色性	輸入電壓	發光角度	材質
1	LED-E27ED6YSTR3	6.5W	2300K	760LM	E27	≥ 80	100-240V (全電壓)	320°
2	LED-E27ED6G95R3	6.5W	2700K	840LM	E27			
3	LED-E27ED6CR3	6.5W	2700K	840LM	E27			
4	LED-E27ED4CR3	4W	2700K	500LM	E27			
5	LED-E14ED4TAR3	4W	2700K	490LM	E14			
6	LED-E14ED4WCR3	4W	2700K	490LM	E14			

## CNS 認證版燈管



1. 雙邊雙腳入電，無方向性
2. 內含保護裝置，更安全
3. 光束維持率可達額定壽命 70% 以上

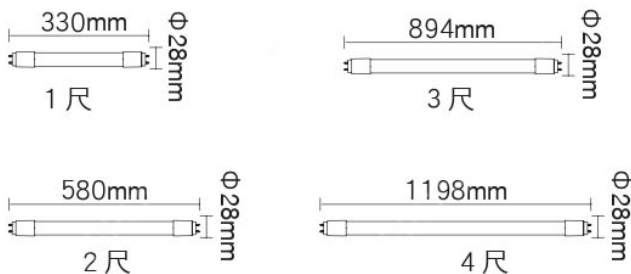

產品型號	消耗電力	色溫	光通量	演色性	輸入電壓	發光角度	燈體材質
LED-T820DR6	20W	6500K	2200LM	≥ 80	100-240V (全電壓)	300°	耐熱燈頭 玻璃 軟燈板
LED-T820NR6	20W	4000K	2200LM				
LED-T820WR6	20W	3000K	2200LM				
LED-T815DR6	15W	6500K	1650LM				
LED-T810DR6	10W	6500K	1100LM				
LED-T810NR6	10W	4000K	1100LM				
LED-T810WR6	10W	3000K	1100LM				
LED-T85DR6	5W	6500K	550LM				
LED-T85WR6	5W	3000K	550LM				



## 高光效節標專用燈管

< 2022 Q2 上市 >



### 2022 年燈管強制認證特點

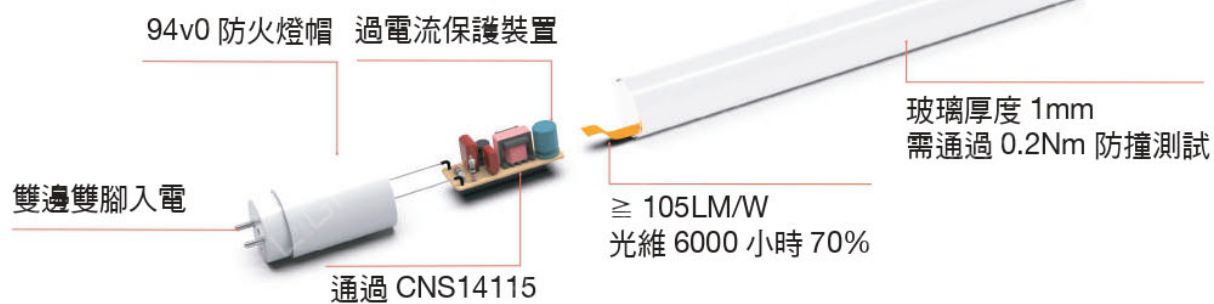

1. 發光效率高達 160LM/W
2. 雙邊雙腳入電，無方向性
3. 內含保護裝置，更安全
4. 光束維持率可達額定壽命 70% 以上

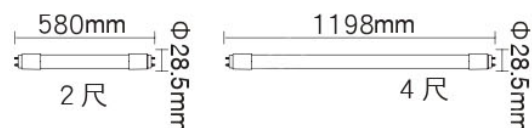

產品型號	消耗電力	色溫	光通量	演色性	輸入電壓	發光角度	燈體材質
LED-T813D-ESR1	13W	6500K	2100LM	≥ 80	100-240V (全電壓)	300°	耐熱燈頭 鋁基板、玻璃
LED-T813D-57KR1	13W	5700K	2100LM				
LED-T87D-ESR1	6.5W	6500K	1050LM				
LED-T87D-57KR1	6.5W	5700K	1050LM				

## 室內停車場專用微波燈管



CCAG21LP0530T8  
國家通訊傳播委員會

145  
LM/W

微波  
感應



1198mm  
4 尺  
Φ28.5mm

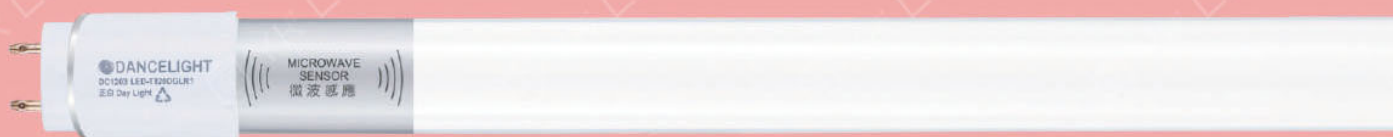

※微波感應燈管：是利用偵測物體移動的頻率，感應雷達微波動作來啟動燈管點亮。其感應距離可達 8 米長，無人時保持在 20% 亮度，只需耗損 20% 電力；當有人車經過時，則會啟動燈管點亮至 100% 並點燈**一分鐘**。需要時才點燈，進而達到節能的效果。

## 微波感應燈管

4,000

產品型號	消耗電力	色溫	光通量	演色性	輸入電壓	發光角度	燈體材質
LED-T815DR1-MS	15W	6500K	2200LM	≥ 80	100-240V (全電壓)	300°	塑包玻



## LED 紅 / 藍色管

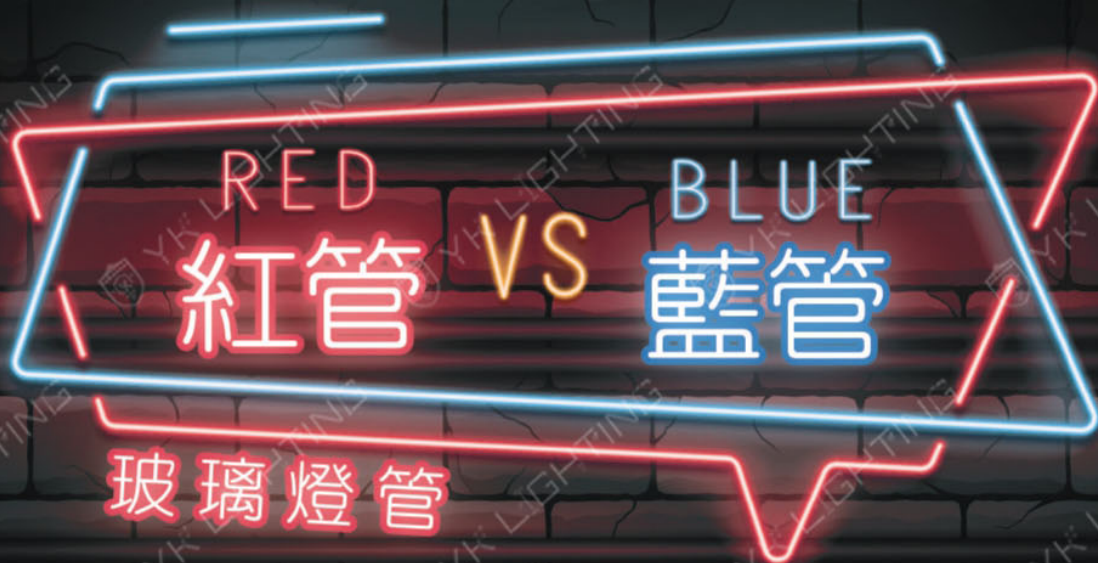

LED RED 紅管



LED BLUE 藍管



1. 採用有色晶片飽和度高
2. 玻璃材質，透光度高
3. 適用於娛樂場所 / 商業場所



4 尺藍 **3,300**    4 尺紅 **3,300**    2 尺藍 **2,300**    2 尺紅 **2,300**

產品型號	消耗電力	波長	輸入電壓	發光角度	燈體材質
LED-T820BGLR3	20W	460nm (藍色)	100-240V (全電壓)	300°	玻璃
LED-T820RGLR3	20W	620nm (紅色)			
LED-T810BGLR3	10W	460nm (藍色)			
LED-T810RGLR3	10W	620nm (紅色)			

## LED 防水廣告燈管

IP66

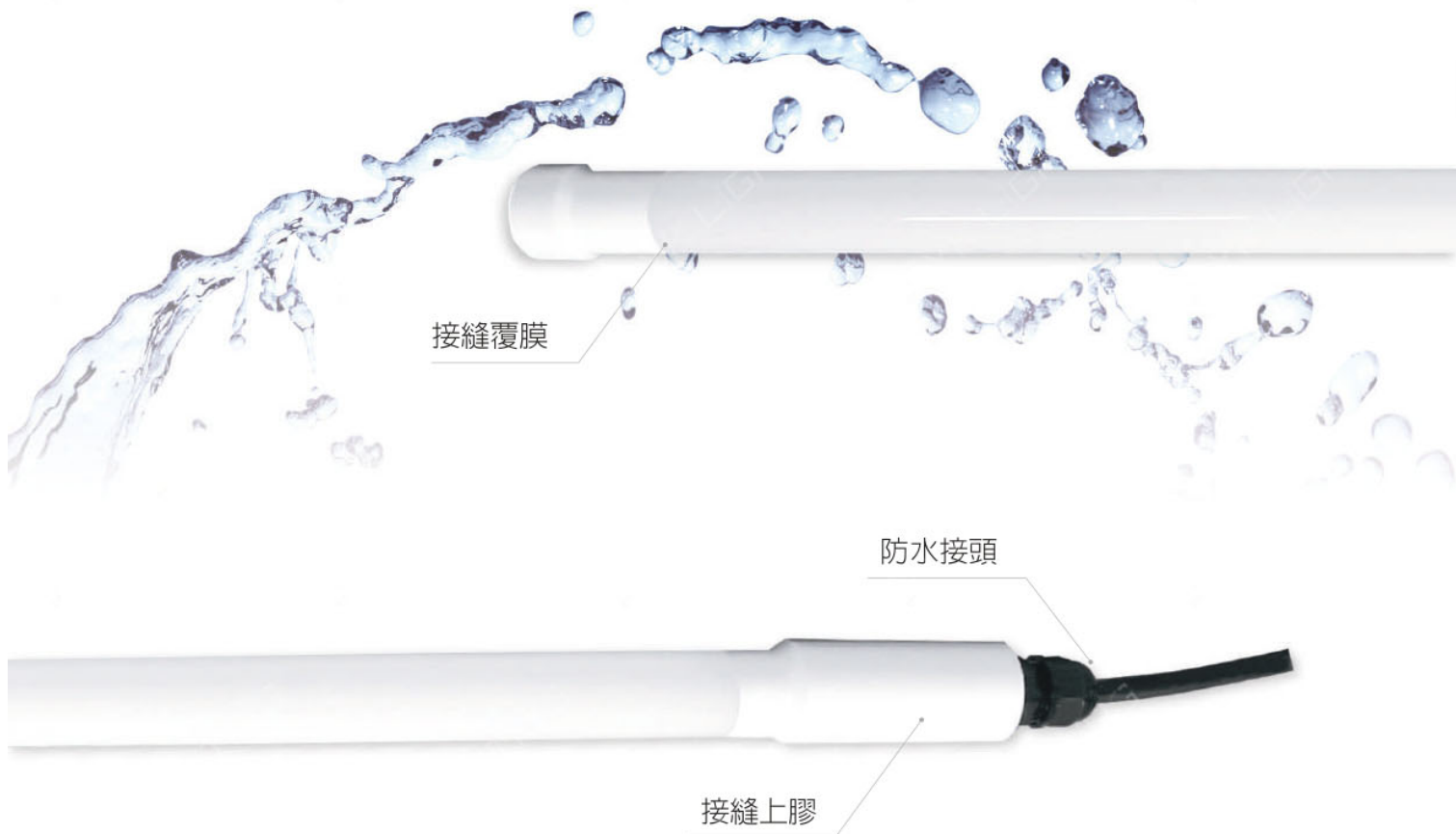

## 可搭配件 (另購)



燈管夾 XX-T8CLIP

1. 出線長 50cm 方便安裝
2. 耐熱橡膠電線材質不脆化
3. IP66 三重防水結構
4. 適用於招牌、戶外照明
5. 可安裝於  $-20^{\circ}\text{C}$  低溫環境



安裝應用



2,000

產品型號	消耗電力	色溫	光通量	演色性	輸入電壓	燈體材質
LED-T820DGL-WO	20W	6500K	2000LM	$\geq 80$	100-240V (全電壓)	玻璃 耐熱燈頭 防水覆膜



## LED T5 驅動內藏型燈管

&lt; 2022 Q3 上市 &gt;



內含驅動器

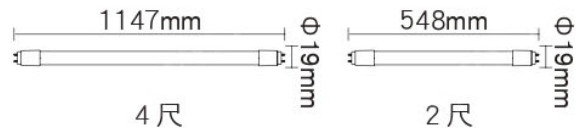

1. 超省電、高亮度發光效率達 130LM/W
2. 需搭配 LED T5 專用燈具 (參考 P.140)

4 尺 **2,500** 2 尺 **2,000**

產品型號	消耗電力	色溫	光通量	演色性	輸入電壓	發光角度	燈體材質
LED-T515D	15W	6500K	2000LM	≥ 80	100-240V (全電壓)	300°	玻璃
LED-T515W	15W	3000K	2000LM				
LED-T58D	7.5W	6500K	1000LM				
LED-T58W	7.5W	3000K	1000LM				

## LED T5 替換型燈管

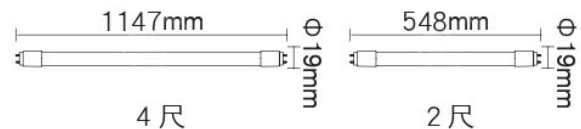

1. 超省電、高亮度發光效率達 100LM/W
2. 低光衰 2000 小時光束維持率 99%
3. 需搭配 T5 螢光燈高功電子安定器使用

4 尺 **2,000** 2 尺 **1,800**

產品型號	消耗電力	色溫	光通量	演色性	安定器	發光角度	燈體材質
LED-T520DGL	20W (不含安定器)	6500K	2000LM	≥ 80	需外接螢光 燈安定器	300°	塑包玻
LED-T520WGL	20W (不含安定器)	3000K	1800LM				
LED-T510DGL	10W (不含安定器)	6500K	1000LM				
LED-T510WGL	10W (不含安定器)	3000K	900LM				

## 9W AR111 投射模組



1. 超高演色性呈現真實產品色彩
2. 內置驅動安裝便利
3. 三色色溫運用廣泛
4. 烤漆銀百搭各種燈具
5. 全電壓設計好運用

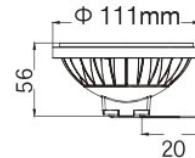
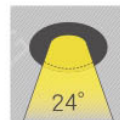

2,800

產品型號	消耗電力	色溫	光通量	演色性	輸入電壓	光束角	燈體材質
LED-ARSP9DR3	9W	5700K	850LM	≥ 90 R9>50	100V-240V (全電壓)	24°	塑包鋁
LED-ARSP9NR3	9W	4000K	850LM				
LED-ARSP9WR3	9W	3000K	800LM				



## 14W AR111 窄角投射模組



1. 超高演色性真實呈現產品色彩
2. 內置驅動安裝便利
3. 三色色溫，銀黑兩色燈體運用廣泛
4. 全電壓設計好運用
5. 重點照明適用於投射物品



3,000

產品型號	燈體顏色	消耗電力	色溫	光通量	演色性	輸入電壓	光束角	燈體材質
LED-ARSP14DR3	質感銀	14W	5700K	1300LM	≥ 90 R9>50	100-240V (全電壓)	24°	塑包鋁
LED-ARSP14NR3		14W	4000K	1300LM				
LED-ARSP14WR3		14W	3000K	1150LM				
LED-ARSP14DR3BK	貴族黑	14W	5700K	1300LM				
LED-ARSP14NR3BK		14W	4000K	1300LM				
LED-ARSP14WR3BK		14W	3000K	1150LM				

## 14W AR111 廣角基礎模組



1. 超高演色性真實呈現產品色彩
2. 內置驅動安裝便利
3. 三色色溫，銀黑兩色燈體運用廣泛
4. 全電壓設計好運用
5. 基礎照明適用於居家環境



3,000

產品型號	燈體顏色	消耗電力	色溫	光通量	演色性	輸入電壓	發光角度	燈體材質
LED-ARFL14DR3	質感銀	14W	5700K	1300LM	≥ 90 R9>50	100-240V (全電壓)	140°	塑包鋁
LED-ARFL14NR3		14W	4000K	1300LM				
LED-ARFL14WR3		14W	3000K	1150LM				
LED-ARFL14DR3BK	貴族黑	14W	5700K	1300LM				
LED-ARFL14NR3BK		14W	4000K	1300LM				
LED-ARFL14WR3BK		14W	3000K	1150LM				

## MR16 投射燈



LED-MR168WR2



LED-MR166WR3

1. 高演色性 RA80，可讓產品色彩更逼真
2. 無紫外線，無熱光線
3. 可直接替換傳統鹵素燈具
4. 省電 80% 以上 (和鹵素燈泡比)
5. 壽命高達 15 倍以上 (和鹵素燈泡比)



全電壓 MR16 驅動器另計

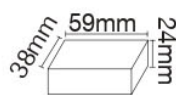

BF-LED8WA

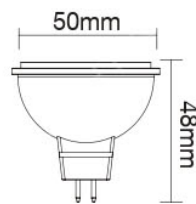

LED-MR168WR2

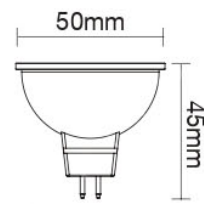

LED-MR166WR3

時價

產品型號	消耗電力	色溫	光通量	演色性	輸入電壓	光束角	燈體材質
LED-MR166DR3	6W (含驅動器)	6000K	400LM	≥ 80	DC12V (需外接驅動器)	36°	塑包鋁
LED-MR166NR3	6W (含驅動器)	4000K	400LM				
LED-MR166WR3	6W (含驅動器)	3000K	400LM				
LED-MR168WR2	8W (含驅動器)	3000K	550LM				



## MR16 免驅投射燈

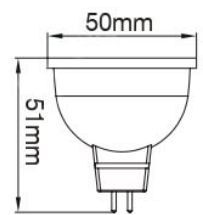

1,500

1. 內置驅動器，安裝好便利
2. 全電壓設計好運用

產品型號	消耗電力	色溫	光通量	演色性	輸入電壓	光束角	燈體材質
LED-MR166DR1-NP	6W	6500K	600LM	≥ 80	100V-240V (全電壓)	36°	塑包鋁
LED-MR166NR1-NP	6W	4000K	600LM				
LED-MR166WR1-NP	6W	3000K	550LM				

防水紅外線感應器

IP66



內部結構圖

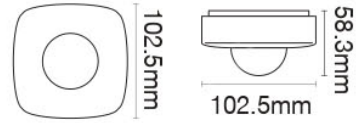

5,000

1. 搭配戶外燈具用
2. 利用人體溫度感應
3. 感應直徑 :16 米
4. 可調亮燈時間 :10 秒至 30 分
5. 可調感測照度 :3 至 300lux./ 白天模式



旋鈕特寫

產品型號	RP-IS1024-WO
感應方式	紅外線
輸入電壓	110V-240V( 全電壓 )
燈體材質	PC 抗 UV 材質
尺寸	L: 102.5mm W: 102.5mm H: 58.3mm
感應時間	10 秒 ~30 分
最大負載	110V-500W, 220V-1000W

防水光感定時器

IP65



內部結構圖

防水光感定時器

1. 搭配戶外燈具用
2. IP65 防塵防水
3. 利用自然環境光感應
4. 可調亮燈時間 :1 至 9 小時
5. 可調感測照度 :3 至 500lux.



旋鈕特寫

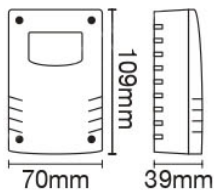

4,000

產品型號	RP-LS1024-T
感應方式	光感
輸入電壓	110V-240V( 全電壓 )
燈體材質	PC 抗 UV 材質
最大負載	110V-770W, 220V-1540W

光感應器

IP44



光感應器

1. 搭配戶外燈具用
2. IP44 防塵防水
3. 利用自然環境光感應
4. 可調感測照度 :5 至 50lux.

※ 請勿倒裝

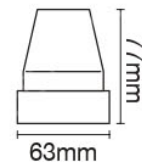

1,500

產品型號	RP-LS1024-7A
感應方式	光感
輸入電壓	110V-240V( 全電壓 )
燈體材質	PC 抗 UV 材質
最大負載	110V-770W, 220V-1540W



## 室內微波感應器



內部結構圖

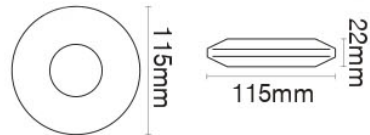

4,800

1. 搭配室內燈具用
2. 偵測物體移動，不受環境溫度影響
3. 可調整感應直徑 2-16 米
4. 可調整點燈時間 :10 秒至 12 分
5. 可調感測照度 :3 至 300lux./ 白天模式

※ 請避免用於 5G WIFI 環境，以免受干擾

產品型號	RP-MS1024
感應方式	微波
輸入電壓	110V-240V(全電壓)
燈體材質	PC 抗 UV 材質
尺寸	φ115mm H:22mm
感應時間	10 秒~12 分
最大負載	110V-500W, 200V-1000W

## 室內紅外線感應器



內部結構圖



3,000

1. 搭配室內燈具用
2. 利用人體溫度感應
3. 感應直徑 6 米
4. 可調亮燈時間 :10 秒至 15 分
5. 可調感測照度 :3 至 300lux./ 白天模式

產品型號	RP-IS1024
感應方式	紅外線
輸入電壓	110V-240V(全電壓)
燈體材質	PC 抗 UV 材質
尺寸	φ80mm H:41mm
感應時間	10 秒~15 分
最大負載	110V-200W, 220V-300W

## LED 緊急照明燈



LED-28001R1

4,500

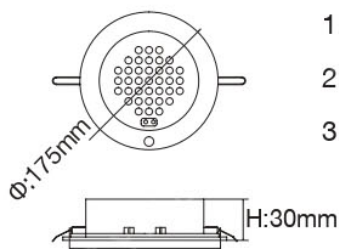

Φ150mm

1. 安裝於出口天花板，安全又美觀
2. 自動充電、停電才亮，節能又方便
3. 電池保固一年、燈體保固兩年，品質有保障



LED-28010

4,500

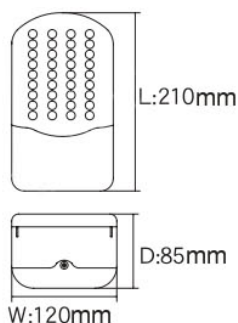

1. 自動充電、停電才亮，節能又方便
2. 電池保固一年、燈體保固兩年，品質有保障

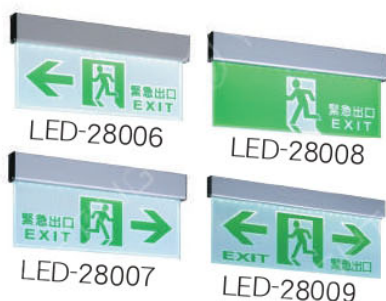

LED-28006/ LED-28008

LED-28007/ LED-28009

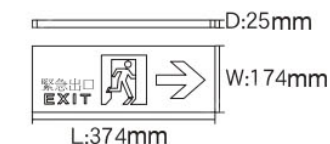

6,000

1. 符合 C 級消防安檢產品
2. 安裝於出口天花板，安全又美觀
3. 自動充電平常亮、停電亮，節能又方便
4. 電池保固一年、燈體保固兩年，品質有保障

產品型號	消耗電力	燈體材質	電池規格	輸入電壓	充電時間	照明時間	點燈方式
LED-28001R1	2.59W	塑料	鎳鎘電池 3.6V 700mAh	110V-220V (全電壓)	48 小時	1.5 小時	停電才亮
LED-28010	2.52W	塑料					停電才亮
LED-28006(左) LED-28007(右) LED-28008(出口) LED-28009(雙向)	3.7 W	鐵 + 壓克力 PMMA	鎳鎘電池 3.6V 400mAh		36 小時	1 小時	平常亮 停電亮